

PACKAGE DIMENSIONS (UNIT: mm)

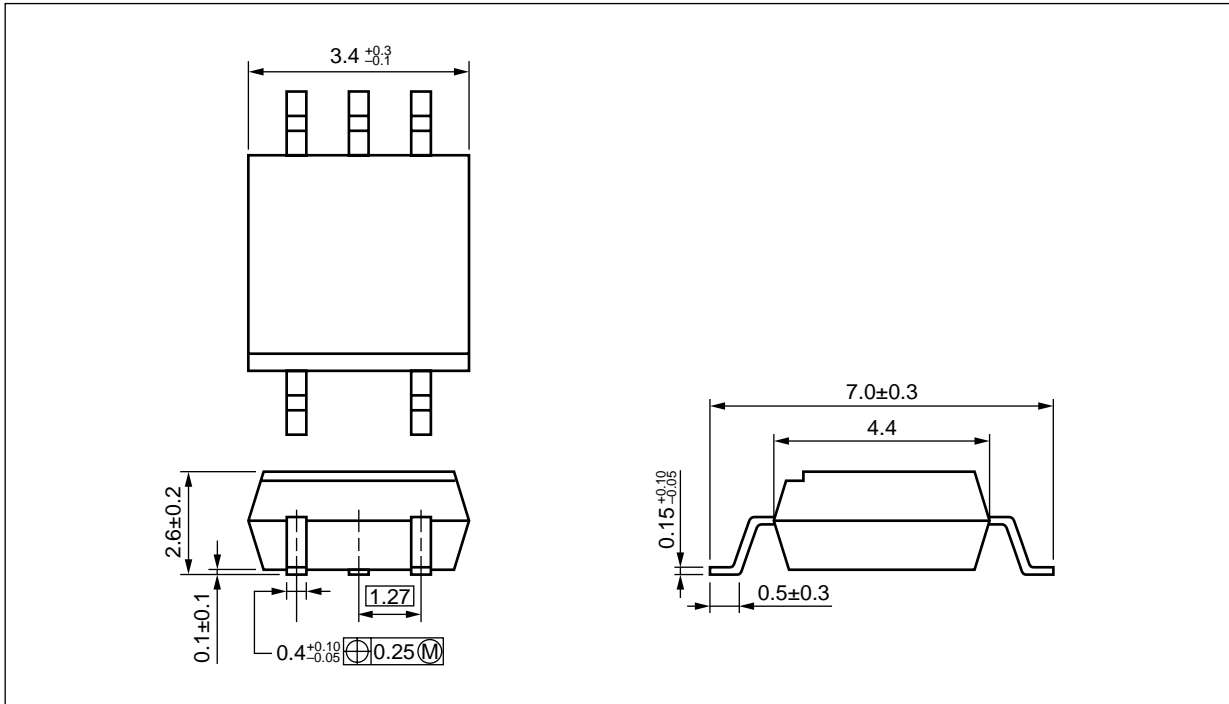

MARKING EXAMPLE

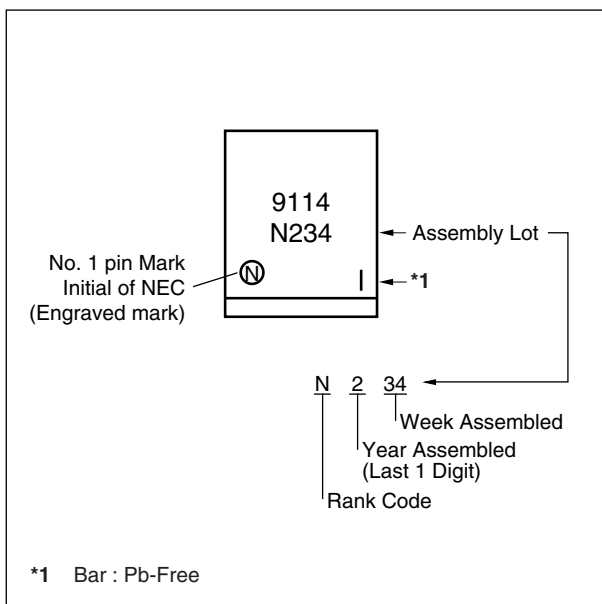

★ **ORDERING INFORMATION**

Part Number	Order Number	Solder Plating Specification	Packing Style	Safety Standard Approval	Application Part Number ^{*1}
PS9114	PS9114-A	Pb-Free	20 pcs (Tape 20 pcs cut)	Standard products (UL approved)	PS9114
PS9114-F3	PS9114-F3-A		Embossed Tape 2 500 pcs/reel		
PS9114-F4	PS9114-F4-A				
PS9114-V	PS9114-V-A		20 pcs (Tape 20 pcs cut)	DIN EN60747-5-2 (VDE0884 Part2) Approved (Option)	
PS9114-V-F3	PS9114-V-F3-A		Embossed Tape 2 500 pcs/reel		
PS9114-V-F4	PS9114-V-F4-A				

*1 For the application of the Safety Standard, following part number should be used.

ABSOLUTE MAXIMUM RATINGS (T_A = 25°C, unless otherwise specified)

Parameter		Symbol	Ratings	Unit
Diode	Forward Current ^{*1}	I _F	30	mA
	Reverse Voltage	V _R	5	V
Detector	Supply Voltage	V _{CC}	7	V
	Output Voltage	V _O	7	V
	Output Current	I _O	25	mA
	Power Dissipation ^{*2}	P _C	40	mW
Isolation Voltage ^{*3}		BV	2 500	Vr.m.s.
Operating Ambient Temperature		T _A	-40 to +85	°C
Storage Temperature		T _{stg}	-55 to +125	°C

*1 Reduced to 0.3 mA/°C at T_A = 25°C or more.

*2 Applies to output pin V_O. Reduced to 1.5 mW/°C at T_A = 65°C or more.

*3 AC voltage for 1 minute at T_A = 25°C, RH = 60% between input and output.

★ Pins 1-2 shorted together, 3-5 shorted together.

RECOMMENDED OPERATING CONDITIONS

Parameter	Symbol	MIN.	TYP.	MAX.	Unit
Low Level Input Voltage	V _{FL}	0		0.8	V
High Level Input Current	I _{FH}	6.3	10	12.5	mA
Supply Voltage	V _{CC}	4.5	5.0	5.5	V
TTL (R _L = 1 kΩ, loads)	N			5	
Pull-up resistor	R _L	330		4 k	Ω

ELECTRICAL CHARACTERISTICS (Unless otherwise specified, $T_A = -40$ to $+85^\circ\text{C}$)

Parameter		Symbol	Conditions	MIN.	TYP.* ¹	MAX.	Unit
Diode	Forward Voltage	V_F	$I_F = 10 \text{ mA}, T_A = 25^\circ\text{C}$	1.4	1.65	1.9	V
	Reverse Current	I_R	$V_R = 3 \text{ V}, T_A = 25^\circ\text{C}$			10	μA
	Terminal Capacitance	C_t	$V = 0 \text{ V}, f = 1 \text{ MHz}, T_A = 25^\circ\text{C}$		30		pF
Detector	High Level Output Current	I_{OH}	$V_{CC} = V_O = 5.5 \text{ V}, V_F = 0.8 \text{ V}$		0.02	250	μA
	Low Level Output Voltage* ²	V_{OL}	$V_{CC} = 5.5 \text{ V}, I_F = 5 \text{ mA}, I_{OL} = 13 \text{ mA}$		0.15	0.6	V
	High Level Supply Current	I_{CCH}	$V_{CC} = 5.5 \text{ V}, I_F = 0 \text{ mA}, V_O = \text{open}$		3	8	mA
	Low Level Supply Current	I_{CCL}	$V_{CC} = 5.5 \text{ V}, I_F = 10 \text{ mA}, V_O = \text{open}$		7.0	11	mA
Coupled	Threshold Input Current (H \rightarrow L)	I_{FHL}	$V_{CC} = 5 \text{ V}, V_O = 0.8 \text{ V}, R_L = 350 \Omega$		2	5	mA
	Isolation Resistance	R_{I-O}	$V_{I-O} = 1 \text{ kV}_{DC}, R_H = 40 \text{ to } 60\%, T_A = 25^\circ\text{C}$	10^{11}			Ω
	Isolation Capacitance	C_{I-O}	$V = 0 \text{ V}, f = 1 \text{ MHz}, T_A = 25^\circ\text{C}$		0.6		pF
	Propagation Delay Time (H \rightarrow L)* ³	t_{PHL}	$T_A = 25^\circ\text{C}$		54	75	ns
			$V_{CC} = 5 \text{ V}, R_L = 350 \Omega, I_F = 7.5 \text{ mA}$			100	
	Propagation Delay Time (L \rightarrow H)* ³	t_{PLH}	$T_A = 25^\circ\text{C}$		51	75	ns
			$V_{CC} = 5 \text{ V}, R_L = 350 \Omega, I_F = 7.5 \text{ mA}$			100	
	Rise Time	t_r	$V_{CC} = 5 \text{ V}, R_L = 350 \Omega, I_F = 7.5 \text{ mA}$		20		
	Fall Time	t_f	$V_{CC} = 5 \text{ V}, R_L = 350 \Omega, I_F = 7.5 \text{ mA}$		10		
	Pulse Width Distortion (PWD)* ³	$ t_{PHL} - t_{PLH} $	$V_{CC} = 5 \text{ V}, R_L = 350 \Omega, I_F = 7.5 \text{ mA}$		3	50	ns
Propagation Delay Skew	t_{PSK}	$V_{CC} = 5 \text{ V}, R_L = 350 \Omega, I_F = 7.5 \text{ mA}$			60		
Common Mode Transient Immunity at High Level Output* ⁴	CM_H	$R_L = 350 \Omega, T_A = 25^\circ\text{C}, I_F = 0 \text{ mA}, V_{O(MIN)} = 2 \text{ V}, V_{CM} = 1 \text{ kV}$	10	20		kV/ μs	
Common Mode Transient Immunity at Low Level Output* ⁴	CM_L	$R_L = 350 \Omega, T_A = 25^\circ\text{C}, I_F = 7.5 \text{ mA}, V_{O(MAX)} = 0.8 \text{ V}, V_{CM} = 1 \text{ kV}$	10	20		kV/ μs	

*1 Typical values at $T_A = 25^\circ\text{C}$

*2 Because V_{OL} of 2 V or more may be output when LED current input and when output supply of $V_{CC} = 2.6\text{ V}$ or less, it is important to confirm the characteristics (operation with the power supply on and off) during design, before using this device.

*3 Test circuit for propagation delay time

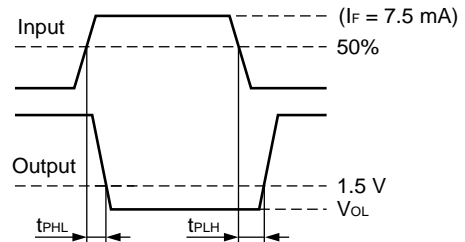
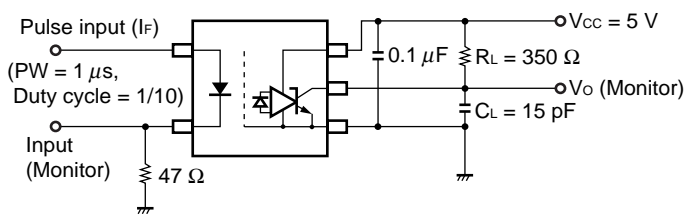

Remark C_L includes probe and stray wiring capacitance.

*4 Test circuit for common mode transient immunity

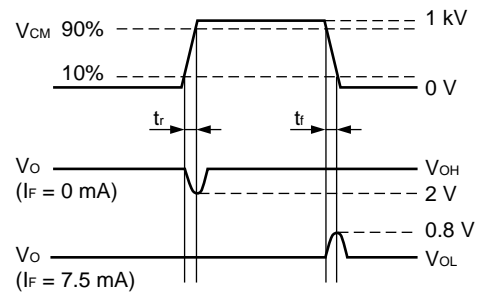
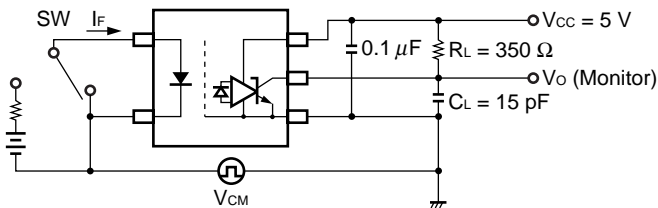

Remark C_L includes probe and stray wiring capacitance.

USAGE CAUTIONS

1. This product is weak for static electricity by designed with high-speed integrated circuit so protect against static electricity when handling.
2. By-pass capacitor of $0.1\ \mu\text{F}$ is used between V_{CC} and GND near device. Also, ensure that the distance between the leads of the photocoupler and capacitor is no more than 10 mm.
3. Avoid storage at a high temperature and high humidity.

TYPICAL CHARACTERISTICS (TA = 25°C, unless otherwise specified)

MAXIMUM FORWARD CURRENT vs. AMBIENT TEMPERATURE

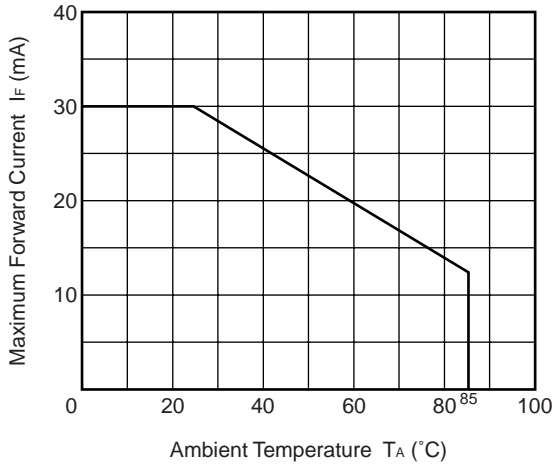

DETECTOR POWER DISSIPATION vs. AMBIENT TEMPERATURE

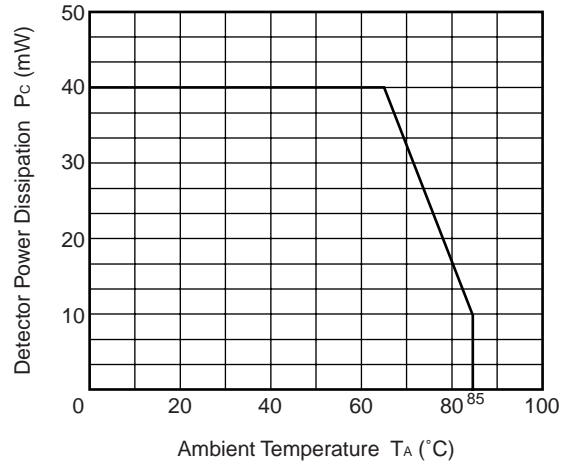

FORWARD CURRENT vs. FORWARD VOLTAGE

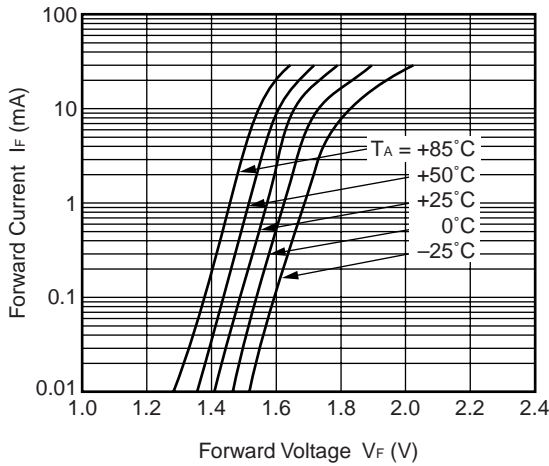

SUPPLY CURRENT vs. AMBIENT TEMPERATURE

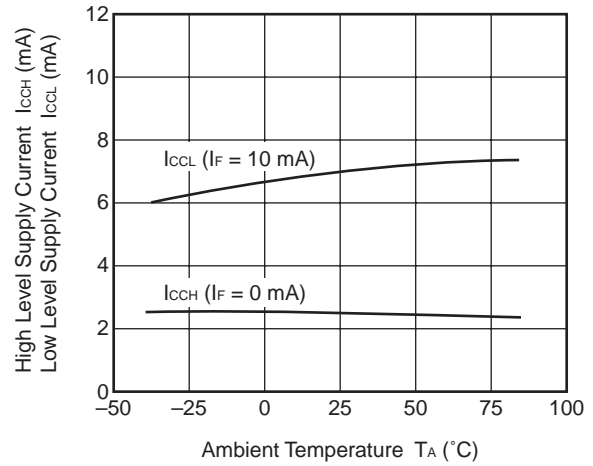

OUTPUT VOLTAGE vs. INPUT CURRENT

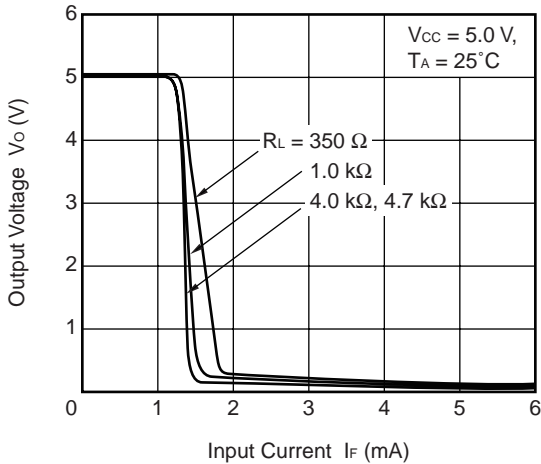

LOW LEVEL OUTPUT VOLTAGE vs. AMBIENT TEMPERATURE

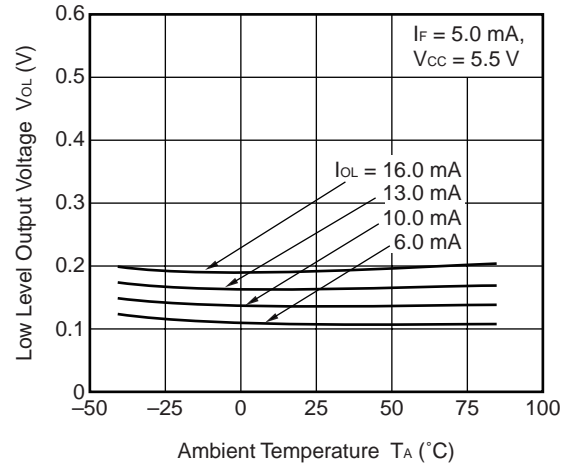

Remark The graphs indicate nominal characteristics.

THRESHOLD INPUT CURRENT vs. AMBIENT TEMPERATURE

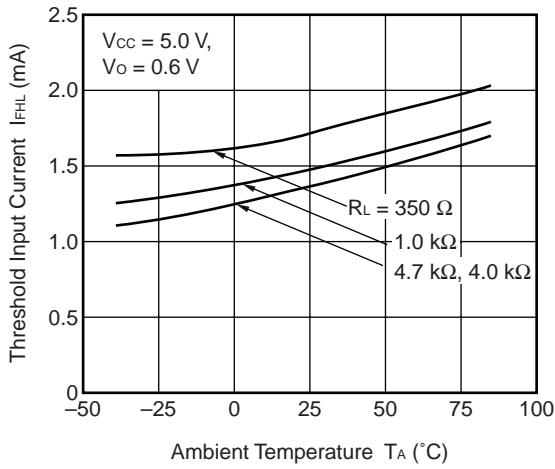

PROPAGATION DELAY TIME vs. AMBIENT TEMPERATURE

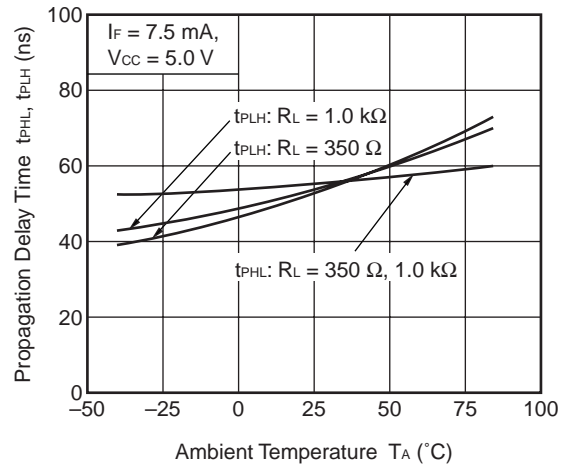

PROPAGATION DELAY TIME vs. AMBIENT TEMPERATURE

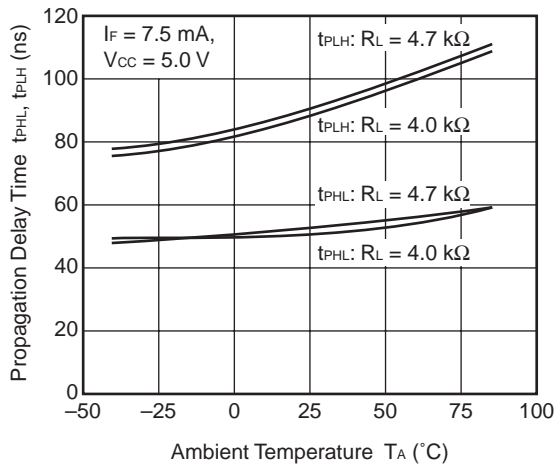

PULSE WIDTH DISTORTION vs. AMBIENT TEMPERATURE

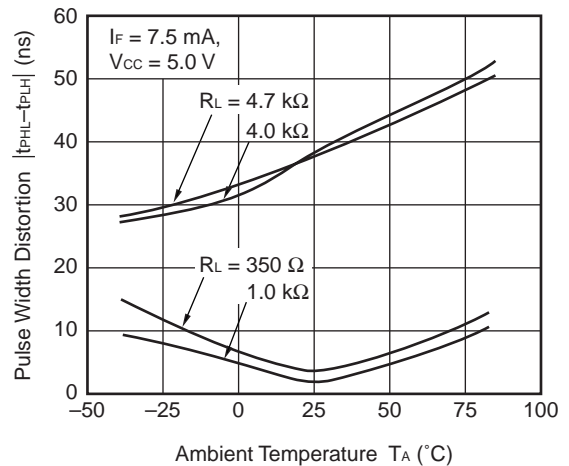

SWITCHING TIME vs. AMBIENT TEMPERATURE

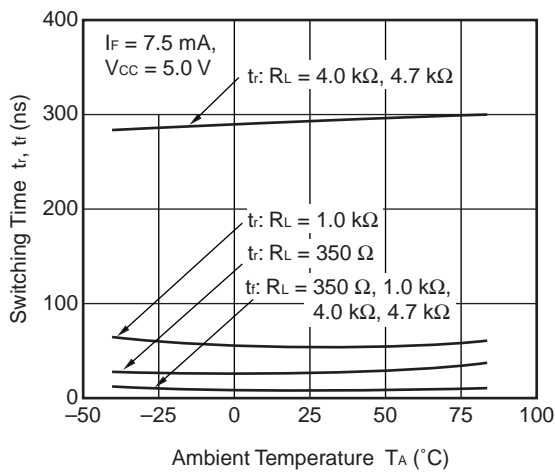

PROPAGATION DELAY TIME vs. INPUT CURRENT

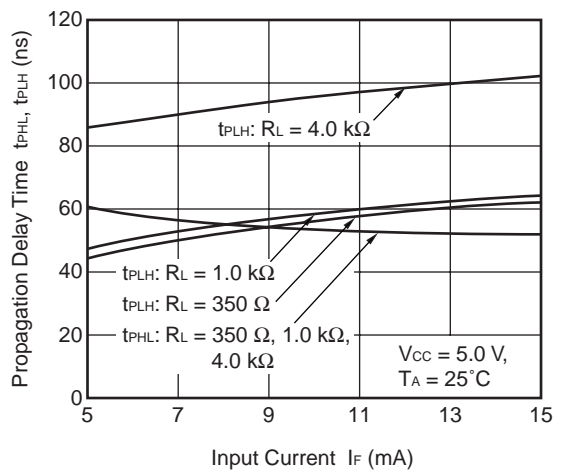

Remark The graphs indicate nominal characteristics.

TAPING SPECIFICATIONS (UNIT: mm)

Outline and Dimensions (Tape)

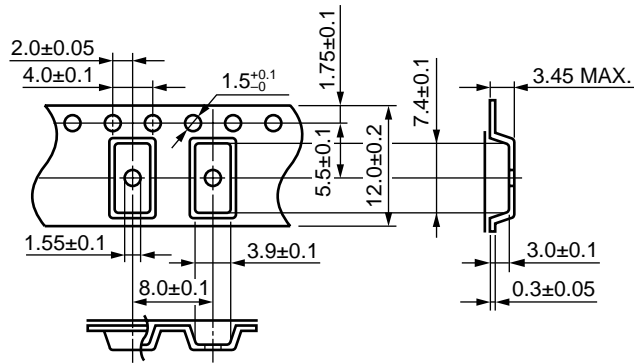

Tape Direction

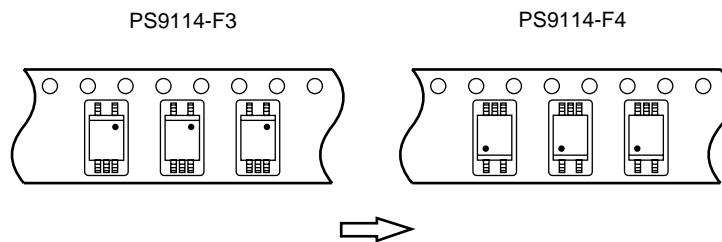

Outline and Dimensions (Reel)

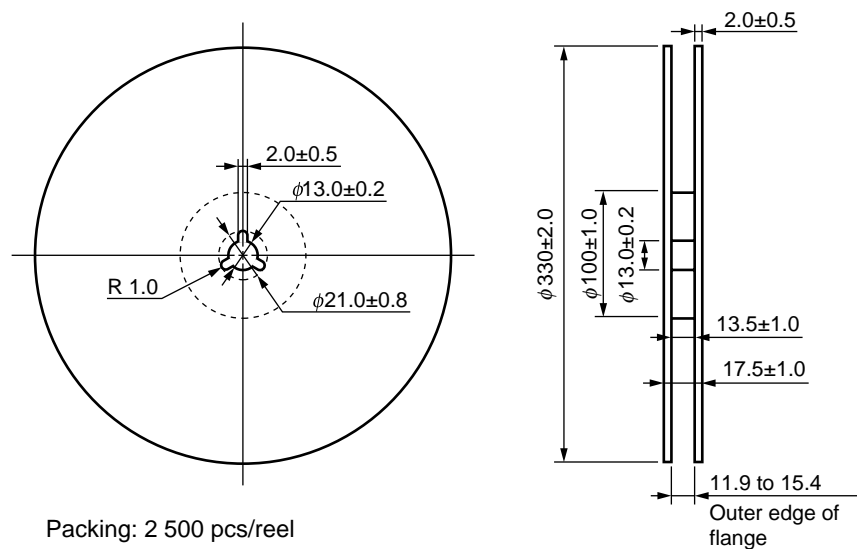

NOTES ON HANDLING

1. Recommended soldering conditions

(1) Infrared reflow soldering

- Peak reflow temperature 260°C or below (package surface temperature)
- Time of peak reflow temperature 10 seconds or less
- Time of temperature higher than 220°C 60 seconds or less
- Time to preheat temperature from 120 to 180°C 120±30 s
- Number of reflows Three
- Flux Rosin flux containing small amount of chlorine (The flux with a maximum chlorine content of 0.2 Wt% is recommended.)

Recommended Temperature Profile of Infrared Reflow

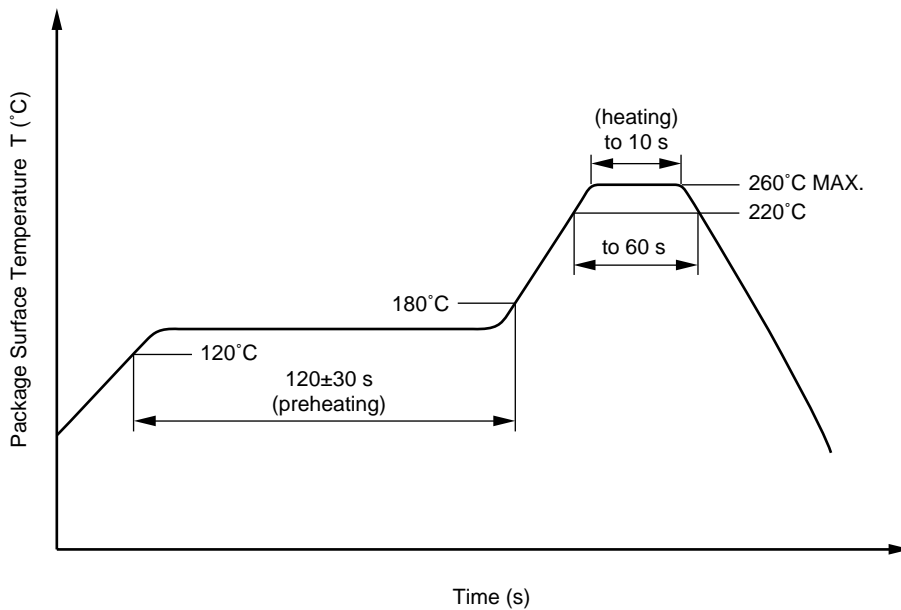

(2) Wave soldering

- Temperature 260°C or below (molten solder temperature)
- Time 10 seconds or less
- Preheating conditions 120°C or below (package surface temperature)
- Number of times One (Allowed to be dipped in solder including plastic mold portion.)
- Flux Rosin flux containing small amount of chlorine (The flux with a maximum chlorine content of 0.2 Wt% is recommended.)

(3) Soldering by Soldering Iron

- Peak Temperature (lead part temperature) 350°C or below
- Time (each pins) 3 seconds or less
- Flux Rosin flux containing small amount of chlorine (The flux with a maximum chlorine content of 0.2 Wt% is recommended.)

(a) Soldering of leads should be made at the point 1.5 to 2.0 mm from the root of the lead

(b) Please be sure that the temperature of the package would not be heated over 100°C

(4) Cautions

- Fluxes

Avoid removing the residual flux with freon-based and chlorine-based cleaning solvent.

2. Cautions regarding noise

Be aware that when voltage is applied suddenly between the photocoupler's input and output or between collector-emitters at startup, the output transistor may enter the on state, even if the voltage is within the absolute maximum ratings.

USAGE CAUTIONS

1. Protect against static electricity when handling.
2. Avoid storage at a high temperature and high humidity.

Subject: Compliance with EU Directives

CEL certifies, to its knowledge, that semiconductor and laser products detailed below are compliant with the requirements of European Union (EU) Directive 2002/95/EC Restriction on Use of Hazardous Substances in electrical and electronic equipment (RoHS) and the requirements of EU Directive 2003/11/EC Restriction on Penta and Octa BDE.

CEL Pb-free products have the same base part number with a suffix added. The suffix –A indicates that the device is Pb-free. The –AZ suffix is used to designate devices containing Pb which are exempted from the requirement of RoHS directive (*). In all cases the devices have Pb-free terminals. All devices with these suffixes meet the requirements of the RoHS directive.

This status is based on CEL’s understanding of the EU Directives and knowledge of the materials that go into its products as of the date of disclosure of this information.

Restricted Substance per RoHS	Concentration Limit per RoHS (values are not yet fixed)	Concentration contained in CEL devices	
		-A	-AZ
Lead (Pb)	< 1000 PPM	Not Detected	(*)
Mercury	< 1000 PPM	Not Detected	
Cadmium	< 100 PPM	Not Detected	
Hexavalent Chromium	< 1000 PPM	Not Detected	
PBB	< 1000 PPM	Not Detected	
PBDE	< 1000 PPM	Not Detected	

If you should have any additional questions regarding our devices and compliance to environmental standards, please do not hesitate to contact your local representative.

Important Information and Disclaimer: Information provided by CEL on its website or in other communications concerning the substance content of its products represents knowledge and belief as of the date that it is provided. CEL bases its knowledge and belief on information provided by third parties and makes no representation or warranty as to the accuracy of such information. Efforts are underway to better integrate information from third parties. CEL has taken and continues to take reasonable steps to provide representative and accurate information but may not have conducted destructive testing or chemical analysis on incoming materials and chemicals. CEL and CEL suppliers consider certain information to be proprietary, and thus CAS numbers and other limited information may not be available for release.

In no event shall CEL’s liability arising out of such information exceed the total purchase price of the CEL part(s) at issue sold by CEL to customer on an annual basis.

See CEL Terms and Conditions for additional clarification of warranties and liability.

Mouser Electronics

Authorized Distributor

Click to View Pricing, Inventory, Delivery & Lifecycle Information:

[CEL:](#)

[PS9114-F3](#) [PS9114](#) [PS9114-F3-A](#) [PS9114-A](#)