

1. MODEL SELECTION

| PART NUMBER | OUTPUT VOLTAGE | INPUT VOLTAGE | MAX. OUTPUT CURRENT | MAX. OUTPUT POWER | TYPICAL EFFICIENCY |
|-------------|--------------------|--------------------|---------------------|-------------------|--------------------|
| VRAE-03E1A0 | 0.59 VDC - 5.1 VDC | 4.5 VDC - 13.8 VDC | 3 A | 15 W | 91% |

PART NUMBER EXPLANATION

| V | R | AE | - | 03 | E | 1A | x | x |
|----------------|------------------|-------------|---|----------------|--------------|----------------|-----------------|--------------------|
| Mount Type | RoHS | Series Name | | Output Current | Input Range | Output Voltage | Suffix | Package |
| Vertical Mount | RoHS 6 Compliant | SIP | | 3 A | 4.5 - 13.8 V | 0.59 - 5.1 V | 0 – Active High | G – Tray Packaging |

2. ABSOLUTE MAXIMUM RATINGS

| PARAMETER | DESCRIPTION | MIN | TYP | MAX | UNITS |
|----------------------|-------------|------|-----|------|-------|
| Input Supply Voltage | | -0.3 | - | 15 | V |
| Ambient Temperature | | -40 | - | 85 | °C |
| Storage Temperature | | -55 | - | 125 | °C |
| Altitude | | - | - | 2000 | m |

NOTE: All specifications are typical at 25 °C unless otherwise stated.

3. INPUT SPECIFICATIONS

| PARAMETER | DESCRIPTION | MIN | TYP | MAX | UNIT |
|---|---|------|-----|------|------------------|
| Input Voltage | $V_o \leq 3.63$ V | 4.5 | - | 13.8 | V |
| | $V_o > 3.63$ V | 7.0 | - | 13.8 | |
| Input Current (Full load) | An input line fuse must always be used. | - | - | 3 | A |
| Input Current (No load) | | - | 40 | 100 | mA |
| Remote Off Input Current | | - | 10 | 25 | mA |
| Input Reflected Ripple Current (pk-pk) | With simulated source impedance of 1000 nH, 5 Hz to 20 MHz Use a 1000 μ F / 25 V AL-Cap with ESR = 0.03 ohm max and 2*100 μ F/25V Tan-Cap with ESR = 0.013 ohm max at 100 kHz @ 25°C. | - | 30 | 50 | mA |
| Input Reflected Ripple Current (rms) | | - | 10 | 20 | mA |
| I ² t Inrush Current Transient | | - | - | 1 | A ² s |
| Turn-on Voltage Threshold | A 30.1K resistor is connected from Enable to Vin | 4.15 | 4.3 | 4.45 | V |
| Turn-off Voltage Threshold | | 3.7 | 4.1 | 4.3 | V |

NOTE: All specifications are typical at 25 °C unless otherwise stated.

4. OUTPUT SPECIFICATIONS

| PARAMETER | DESCRIPTION | MIN | TYP | MAX | UNIT |
|-----------------------------------|---|-----|------|------|-----------|
| Output Voltage Set Point Accuracy | Vin = 12 V, Iout = full load | -2 | - | +2 | % Vo, set |
| Load Regulation | | - | ±0.2 | ±0.5 | % Vo, set |
| Line Regulation | | - | ±0.2 | ±0.5 | % Vo, set |
| Regulation Over Temperature | | - | 0.3 | 0.5 | % Vo, set |
| Output Current | | 0 | - | 3 | A |
| Output DC Current Limit | | 3.6 | 5 | 7 | A |
| Output Ripple and Noise (pk-pk) | 0 – 20 MHz BW, with a 1 µF ceramic capacitor and a 10 µF tantalum cap at output. | - | 60 | 100 | mV |
| Output Ripple and Noise (rms) | | - | 20 | 40 | mV |
| Short Circuit Surge Transient | | - | - | 2 | A²s |
| Turn-on Time ¹ | Vout = 5.0V; time from enable going high to 90% of Vout | 2 | - | 4 | ms |
| | Vout = 3.3V; time from enable going high to 90% of Vout | 1.8 | - | 3.8 | ms |
| | Vout = 1.8V; time from enable going high to 90% of Vout | 1 | - | 3 | ms |
| | Vout = 0.9V; time from enable going high to 90% of Vout | 1 | - | 3 | ms |
| Rise Time ¹ | Vout = 5.0V; time from 10% to 90% of Vout | - | 2.3 | 2.8 | ms |
| | Vout = 3.3V; time from 10% to 90% of Vout | - | 1.7 | 2.2 | ms |
| | Vout = 1.8V; time from 10% to 90% of Vout | - | 1.2 | 1.7 | ms |
| | Vout = 0.9V; time from 10% to 90% of Vout | - | 1.0 | 1.5 | ms |
| Overshoot at Turn-on | | - | - | 1 | % |
| Output Capacitance | | 0 | - | 1000 | µF |
| TRANSIENT RESPONSE | | | | | |
| 50% ~ 100% Max Load | | - | 120 | 200 | mV |
| Settling Time | di/dt = 2.5 A/µS; Vin =12 V; with 10 µF tantalum cap and 1 µF ceramic at the output, Ta=25 °C | - | 20 | 50 | µs |
| 100% ~ 50% Max Load | | - | 120 | 200 | mV |
| Settling Time | | - | 20 | 50 | µs |

¹ The turn on time is guaranteed to be in between the minimum and maximum limits specified over all operating temperatures. Output capacitance used was 1x 1000 µF aluminum, 1x 10 µF tantalum, and 1x 1 µF ceramic. The turn on waveform with parameter measurement locations is shown below.

NOTE: All specifications are typical at normal input, full load at Ta= 25°C unless otherwise stated.

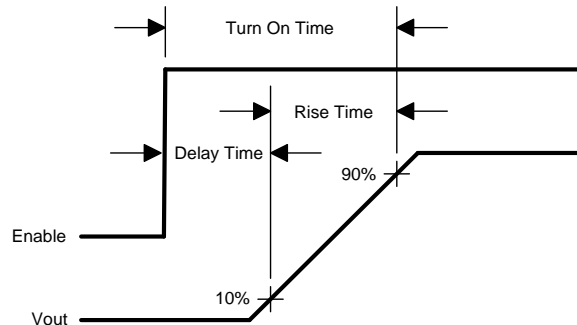

5. GENERAL SPECIFICATIONS

| PARAMETER | DESCRIPTION | MIN | TYP | MAX | UNIT |
|---------------------------|---|-------|----------------------|-----|------|
| Efficiency | $V_o = 5.0\text{ V}$ | 91 | 93 | - | % |
| | $V_o = 3.3\text{ V}$ | 89 | 91 | - | |
| | $V_o = 2.5\text{ V}$ | 87 | 89 | - | |
| | $V_o = 1.8\text{ V}$ | 84 | 86 | - | |
| | $V_o = 1.5\text{ V}$ | 83 | 85 | - | |
| | $V_o = 1.2\text{ V}$ | 80 | 82 | - | |
| | $V_o = 0.9\text{ V}$ | 73 | 75 | - | |
| Switching Frequency | | - | 500 | - | kHz |
| Output Voltage Trim Range | Wide Trim | 0.591 | - | 5.1 | V |
| MTBF | Calculated Per Bell Core SR-332 ($I_o = 80\%$ load; $V_{in} = 12\text{ V}$; $V_o = 5\text{ V}$; 200 LFM; $T_a = 25\text{ }^\circ\text{C}$) | | 7 579 849 | | h |
| Weight | | - | 2.0 | - | g |
| Dimensions (L x W x H) | | | 0.65 x 0.41 x 0.32 | | in |
| | | | 16.51 x 10.41 x 8.13 | | mm |

NOTE: All specifications are typical at 25 °C unless otherwise stated.

6. CONTROL SPECIFICATIONS

| PARAMETER | DESCRIPTION | MIN | TYP | MAX | UNIT |
|------------------------------------|--|-------|-------|-------|---------------|
| Remote On/Off (Active High) | | | | | |
| Turn On Voltage Threshold | Unit is on when voltage on enable pin is driven above the turn on threshold. When enable pin is floating, unit is off. | 0.485 | 0.500 | 0.515 | V |
| Maximum Enable Voltage | Maximum voltage that should be applied to the enable pin. | - | - | 5.5 | V |
| Hysteresis Source Current | A 10 μA current source to GND (I_{EN_HYS}) is active when unit is off and inactive when unit is on (see figure below). | 7.5 | 10 | 11.5 | μA |

NOTE: The following figure shows the internal circuitry for the enable.

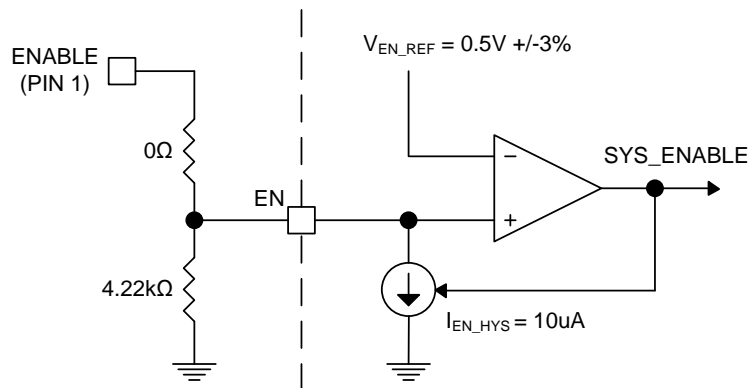

7. OUTPUT TRIM EQUATIONS

Equation for calculating the trim resistor given the desired output voltage (Vo) is shown below. The Rtrim resistor should be connected between the trim pin and GND pin.

$$R_{trim} = \frac{1.182}{V_o - 0.591} k\Omega$$

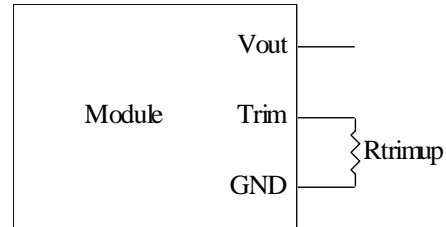

8. RIPPLE AND NOISE WAVEFORM

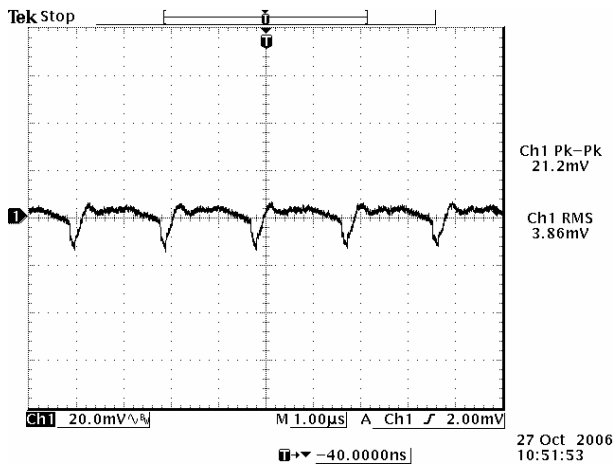

Figure 6. 12 V input, 0.591 V output

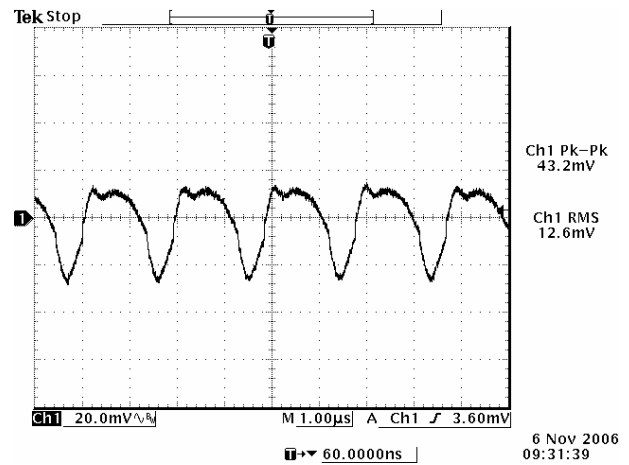

Figure 7. 12 V input, 3.3 V output.

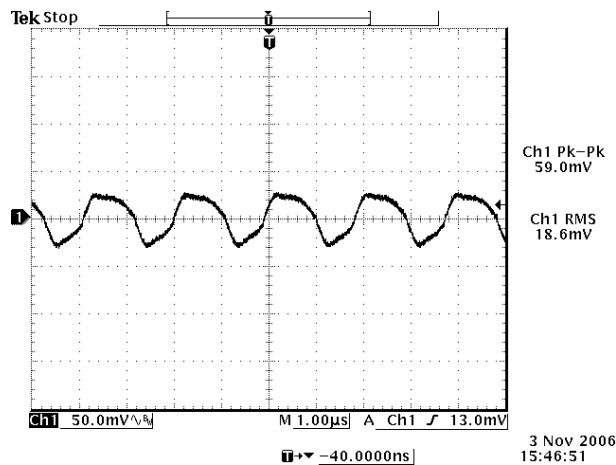
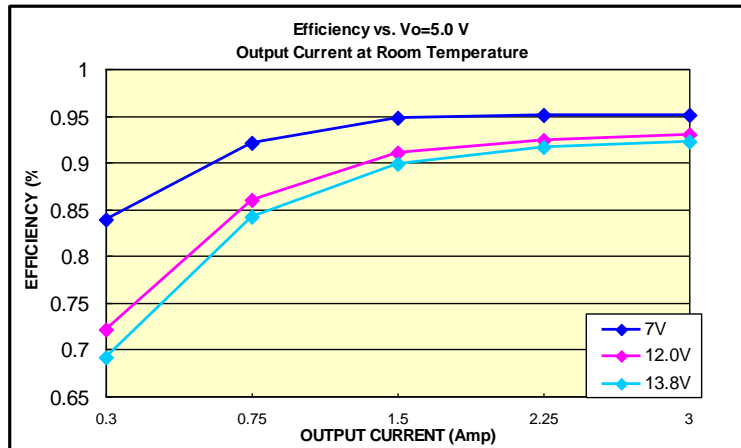
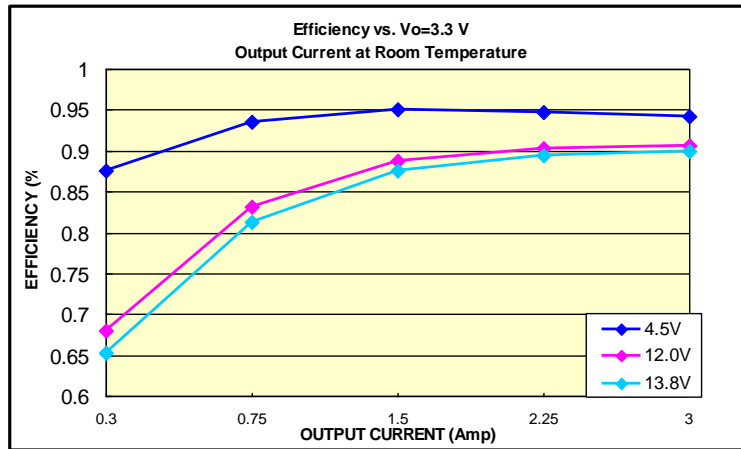
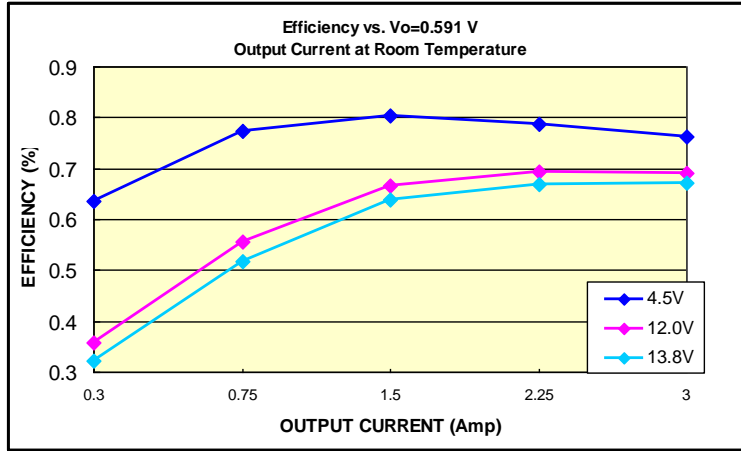

Figure 8. 12 V input, 5.0 V output.

NOTE: Ripple and noise at full load, 0-20 MHz BW, with a 1 µF ceramic cap and a 10 µF tantalum cap, and Ta=25°C.

9. EFFICIENCY DATA



10. THERMAL DERATING CURVES

The thermal reference point T_{ref} is shown below. For reliable operation this temperature should not exceed 115 °C. The output power of the module should not exceed the rated power for the module.

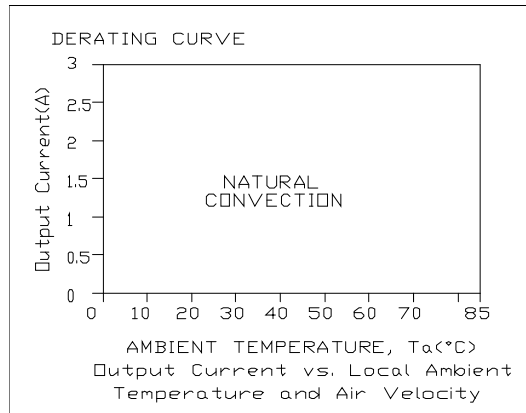
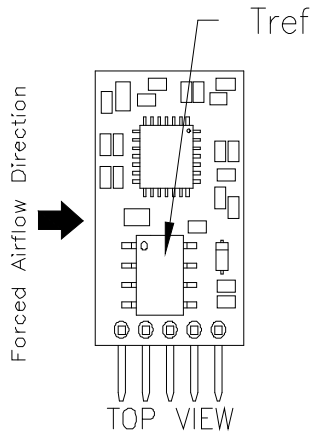

Figure 1. $V_{in}=12\text{ V}$, $V_{out} = 5\text{ V}$

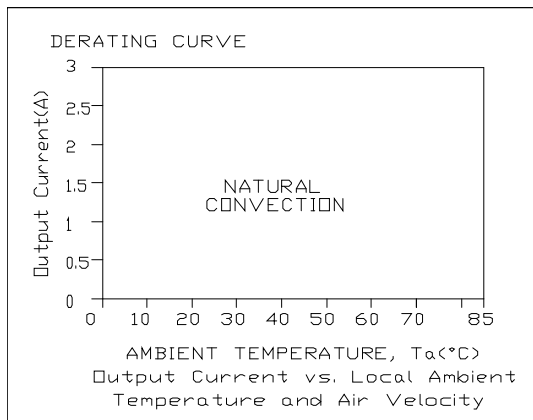

Figure 2. $V_{in}=12\text{ V}$, $V_{out} = 3.3\text{ V}$

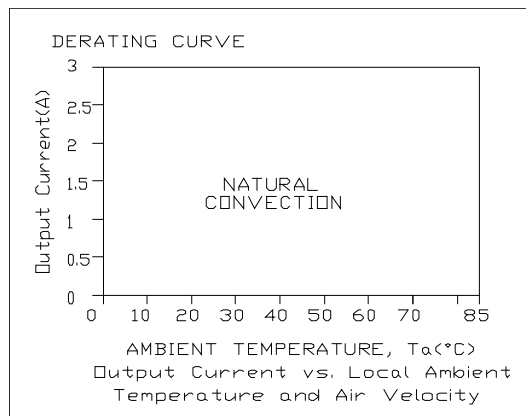

Figure 3. $V_{in}=12\text{ V}$, $V_{out} = 2.5\text{ V}$

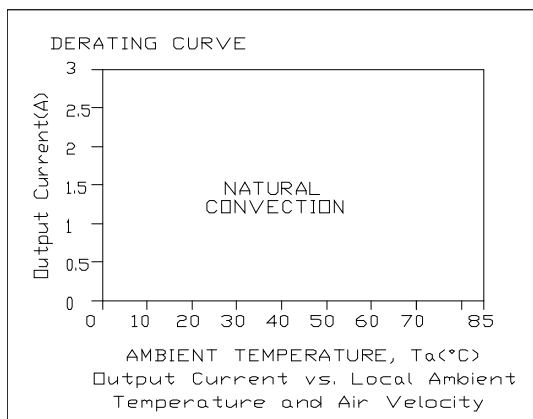

Figure 4. $V_{in}=12\text{ V}$, $V_{out} = 1.2\text{ V}$

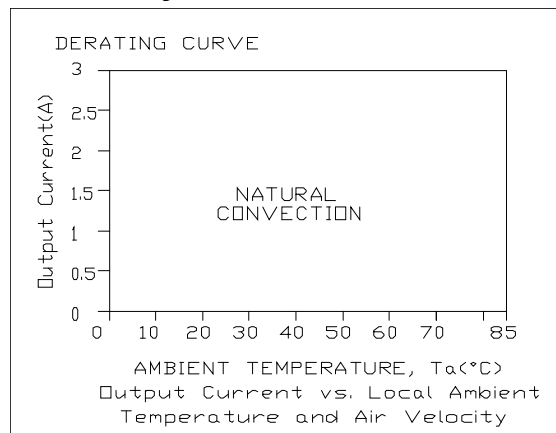

Figure 5. $V_{in}=12\text{ V}$, $V_{out} = 0.59\text{ V}$

11. TRANSIENT RESPONSE WAVEFORMS

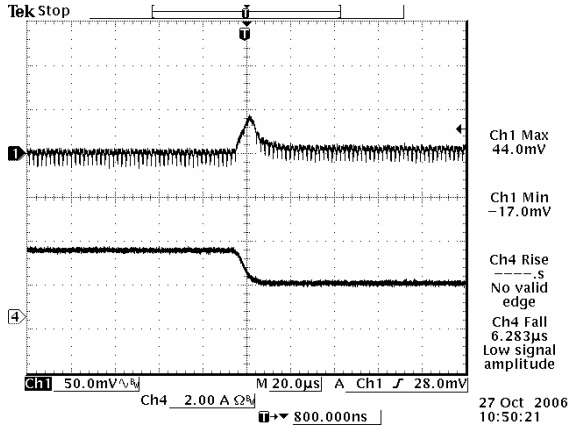

Figure 9. 100% to 50% load step at 12 V input, 0.591 V output

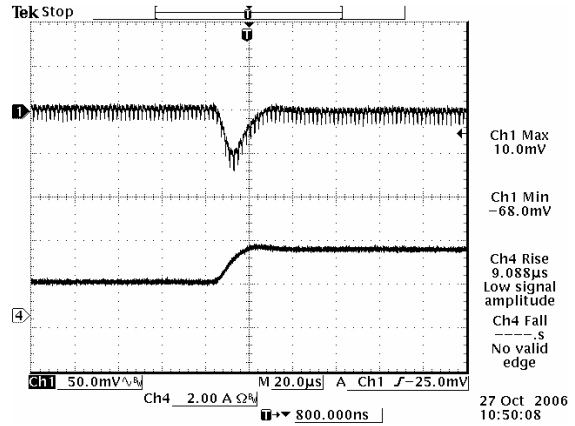

Figure 10. 50% to 100% load step at 12 V input, 0.591 V output

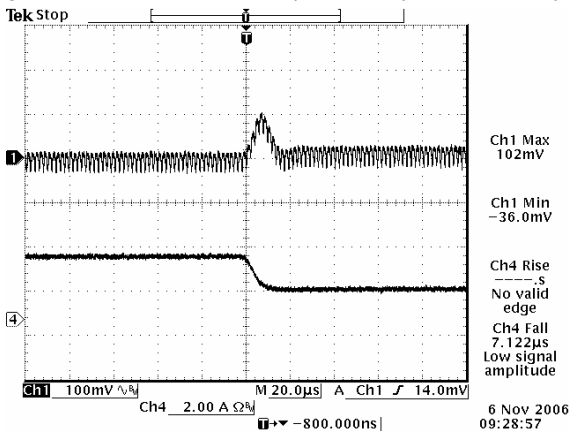

Figure 11. 100% to 50% load step at 12 V input, 3.3 V output

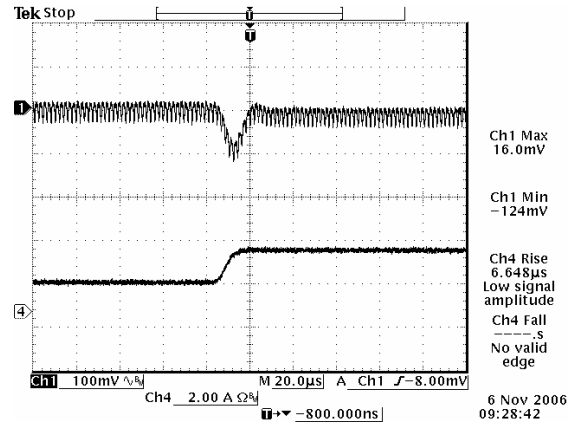

Figure 12. 50% to 100% load step at 12 V input, 3.3 V output

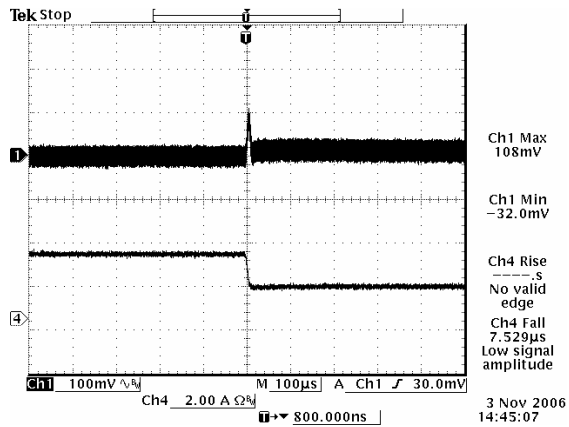

Figure 13. 100% to 50% load step at 12 V input, 5.0 V output

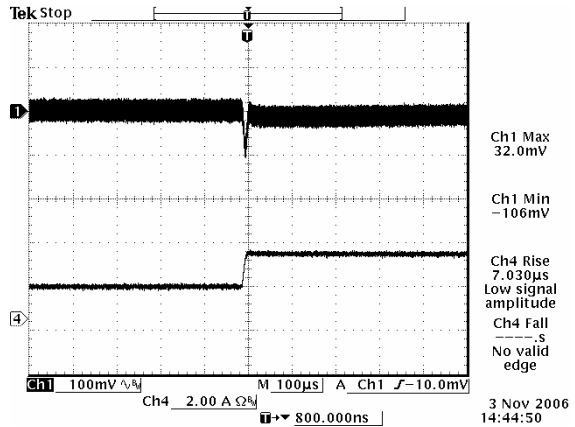
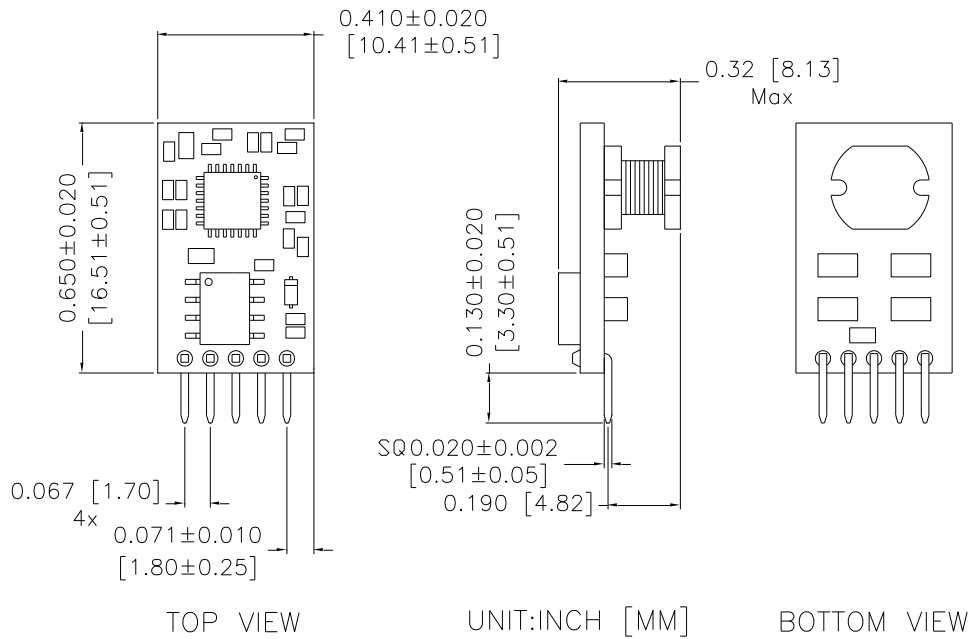

Figure 14. 50% to 100% load step at 12 V input, 5.0 V output

NOTE: Transient response at di/dt=0.25 A/µs, with a 1µF ceramic cap and a 10µF tantalum cap at the output, and Ta=25 °C.

12. MECHANICAL OUTLINE



RECOMMENDED PAD LAYOUT

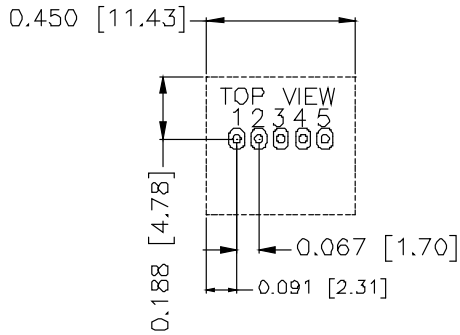

PAD: LENGTH 0.067 [ø1.7] BOTH SIDE
 WIDTH 0.047 [ø1.2] BOTH SIDE
 HOLE: ø0.032 [ø0.8] BOTH SIDE

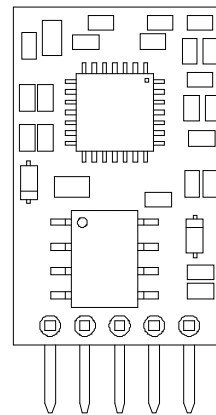

PIN CONNECTIONS

| PIN | NAME |
|-----|--------|
| 1 | ENABLE |
| 2 | Vin |
| 3 | GND |
| 4 | Vout |
| 5 | Trim |

NOTE: This module is recommended and compatible with Pb-Free Wave Soldering and must be soldered using a peak solder temperature of no more than 260°C for less than 5 seconds.

NOTES:

- 1) All Pins: Material - Copper Alloy;
Finish - 3 micro inches minimum Gold over 50 micro inches minimum Nickel plate.
- 2) Undimensioned components are shown for visual reference only.
- 3) All dimensions in inches (mm); Tolerances: x.xx +/-0.02 in [0.5 mm]. x.xxx +/-0.010 in [0.25 mm].

13. ASSEMBLY NOTE

Modules were designed for vertical insertion into host board. Experiments should be performed to make sure that the units meet the intended tilt specification. A fixture may be needed to make the module stand upright in assembly.

14. REVISION HISTORY

| DATE | REVISION | CHANGE DESCRIPTION | APPROVAL |
|------------|----------|--|--------------|
| 2010-4-22 | G | 1. Change operating temp range from 0~70°C to -40~85°C 2. Add the data of full load input current | XF JIANG |
| 2013-4-11 | H | Update Output Specifications and Control Specifications. | XF JIANG |
| 2014-3-24 | I | Update MD | Shiyong Qian |
| 2015-12-28 | J | Update MD | XF JIANG |
| 2017-12-15 | K | Datasheet updated to the new Bel template | |

For more information on these products consult: tech.support@psbel.com

NUCLEAR AND MEDICAL APPLICATIONS - Products are not designed or intended for use as critical components in life support systems, equipment used in hazardous environments, or nuclear control systems.

TECHNICAL REVISIONS - The appearance of products, including safety agency certifications pictured on labels, may change depending on the date manufactured. Specifications are subject to change without notice.



tech.support@psbel.com
belfuse.com/power-solutions

Mouser Electronics

Authorized Distributor

Click to View Pricing, Inventory, Delivery & Lifecycle Information:

[Bel Power Solutions:](#)

[VRAE-03E1A0G](#)