

ELECTRICAL CHARACTERISTICS (At T_A = 25°C unless otherwise noted)

TYPE	NOMINAL ZENER VOLTAGE	TEST CURRENT	MAXIMUM DYNAMIC IMPEDANCE			MAXIMUM DC REVERSE LEAKAGE CURRENT		MAXIMUM SURGE CURRENT	MAXIMUM FORWARD VOLTAGE
	at I _{ZT} V _Z (NOTE 1) (Volts)	I _{ZT} (mA)	Z _{ZT} at I _{ZT} (ohms)	Z _{ZK} at (ohms)	(NOTE 1) I _{ZK} (mA)	I _R (μ A)	V _R (Volts)	(NOTE 2) I _{RM} (mApk)	at 200mA V _F (Volts)
FM4737W	7.5	34.0	4.0	700	0.50	50.0	5.0	605.0	1.2
FM4738W	8.2	31.0	4.5	700	0.50	50.0	6.0	550.0	1.2
FM4739W	9.1	28.0	5.0	700	0.50	50.0	7.0	500.0	1.2
FM4740W	10.0	25.0	7.0	700	0.25	50.0	7.6	454.0	1.2
FM4741W	11.0	23.0	8.0	700	0.25	5.0	8.4	414.0	1.2
FM4742W	12.0	21.0	9.0	700	0.25	5.0	9.1	380.0	1.2
FM4743W	13.0	19.0	10.0	700	0.25	5.0	9.9	344.0	1.2
FM4744W	15.0	17.0	14.0	700	0.25	5.0	11.4	305.0	1.2
FM4745W	16.0	15.5	16.0	700	0.25	5.0	12.2	285.0	1.2
FM4746W	18.0	14.0	20.0	750	0.25	5.0	13.7	250.0	1.2
FM4747W	20.0	12.5	22.0	750	0.25	5.0	15.2	225.0	1.2
FM4748W	22.0	11.5	23.0	750	0.25	5.0	16.7	205.0	1.2
FM4749W	24.0	10.5	25.0	750	0.25	5.0	18.2	190.0	1.2
FM4750W	27.0	9.5	35.0	750	0.25	5.0	20.6	170.0	1.2
FM4751W	30.0	8.5	40.0	1000	0.25	5.0	22.8	150.0	1.2
FM4752W	33.0	7.5	45.0	1000	0.25	5.0	25.1	135.0	1.2
FM4753W	36.0	7.0	50.0	1000	0.25	5.0	27.4	125.0	1.2
FM4754W	39.0	6.5	60.0	1000	0.25	5.0	29.7	115.0	1.2
FM4755W	43.0	6.0	70.0	1500	0.25	5.0	32.7	110.0	1.2
FM4756W	47.0	5.5	80.0	1500	0.25	5.0	35.8	95.0	1.2
FM4757W	51.0	5.0	95.0	1500	0.25	5.0	38.8	90.0	1.2
FM4758W	56.0	4.5	110.0	2000	0.25	5.0	42.6	80.0	1.2
FM4759W	62.0	4.0	125.0	2000	0.25	5.0	47.1	70.0	1.2
FM4760W	68.0	3.7	150.0	2000	0.25	5.0	51.7	65.0	1.2
FM4761W	75.0	3.3	175.0	2000	0.25	5.0	56.0	60.0	1.2
FM4762W	82.0	3.0	200.0	3000	0.25	5.0	62.2	55.0	1.2
FM4763W	91.0	2.0	250.0	3000	0.25	5.0	69.2	50.0	1.2

- Notes :
1. Standard Voltage Tolerance : +/- 20% , Suffix A : +/- 10% , Suffix B : +/- 5% .
 2. Surge current is a non-repetitive, 8.3ms pulse width square wave or equivalent sine-wave superimposed on I_{ZT} per JEDEC Method.
 3. Maximum steady state power dissipation is 1.0 watt at T_L = 75°C.
 4. Available in Halogen-free epoxy by adding suffix -HF after the part nbr.

RATING AND CHARACTERISTICS CURVES (FM4728W THRU FM4763W)

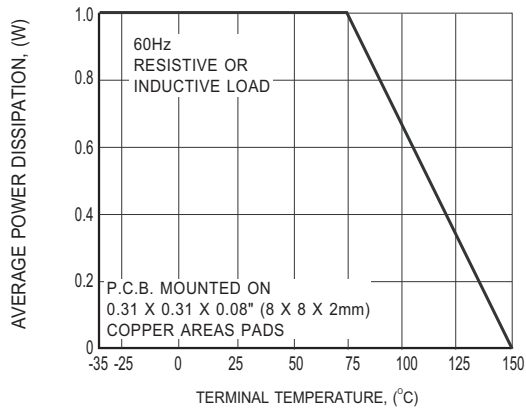

**FIG.1 MAXIMUM CONTINUOUS
POWER DISSIPATION**

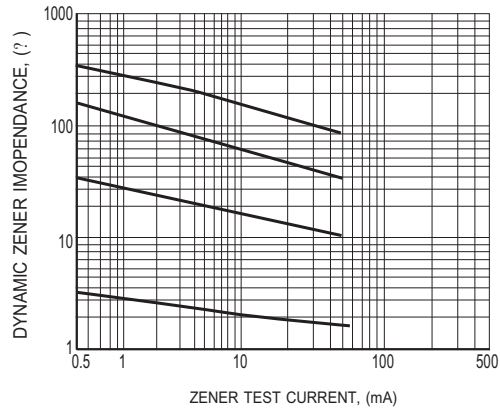

**FIG.2 TYPICAL ZENER
IMPEDANCE**

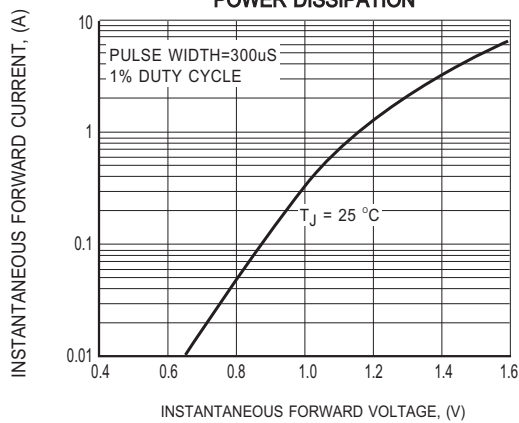

**FIG.3 TYPICAL INSTANTANEOUS FORWARD
CHARACTERISTICS FOR FM4763W**

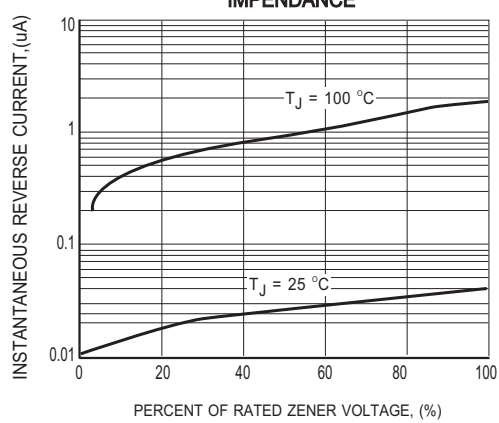

FIG.4 TYPICAL REVERSE CHARACTERISTICS

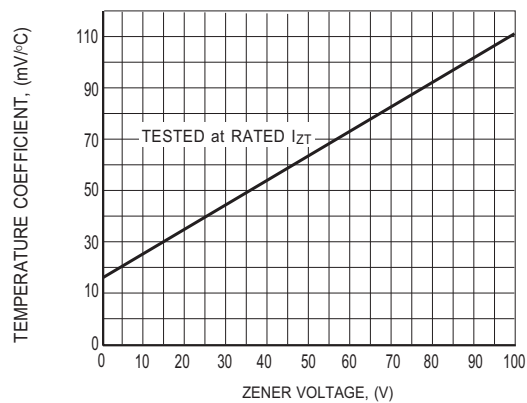
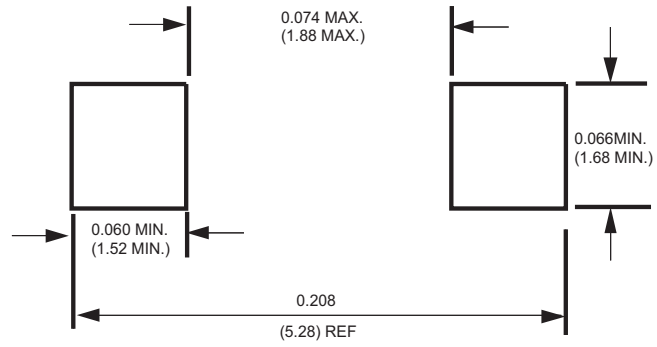

FIG.5 TYPICAL TEMPERATURE COEFFICIENTS

Mounting Pad Layout



Dimensions in inches and (millimeters)

Marking Description

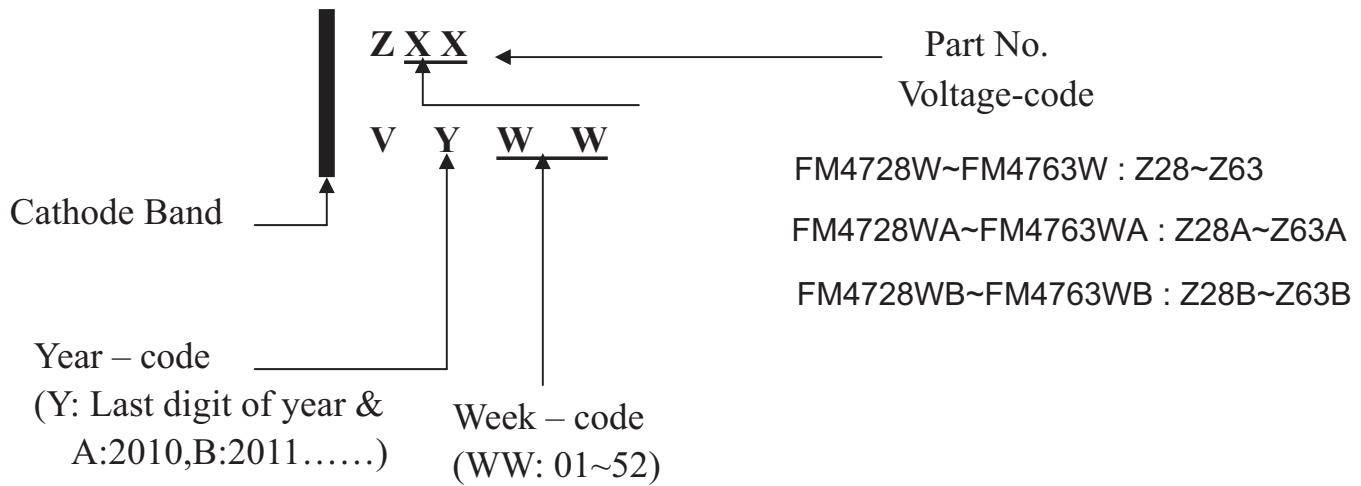
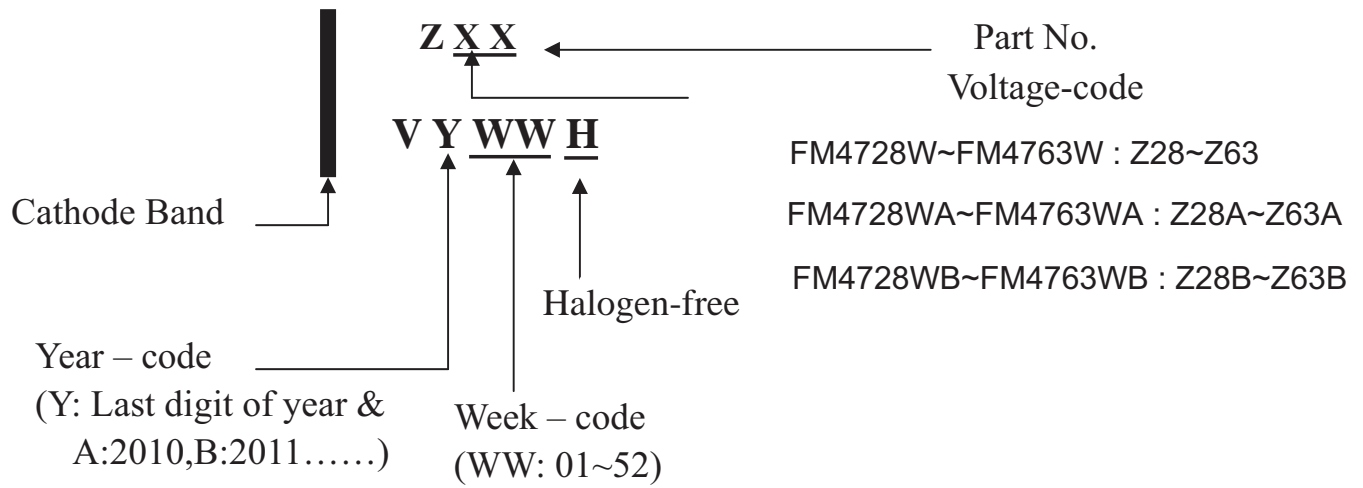

PACKAGING OF DIODE AND BRIDGE RECTIFIERS

REEL PACK

PACKAGE	PACKING CODE	EA PER REEL	EA PER INNER BOX	COMPONENT SPACE (mm)	TAPE SPACE (mm)	REEL DIA (mm)	CARTON SIZE (mm)	EA PER CARTON	GROSS WEIGHT(Kg)
SMA	-W	7,500	15,000	---	---	330	360*355*360	120,000	15.2

PACKAGE	PACKING CODE	EA PER REEL	EA PER INNER BOX	COMPONENT SPACE (mm)	TAPE SPACE (mm)	REEL DIA (mm)	CARTON SIZE (mm)	EA PER CARTON	GROSS WEIGHT(Kg)
SMA	-T	2,000	8,000	---	---	178	390*205*310	64,000	7.8

DISCLAIMER NOTICE

Rectron Inc reserves the right to make changes without notice to any product specification herein, to make corrections, modifications, enhancements or other changes. Rectron Inc or anyone on its behalf assumes no responsibility or liability for any errors or inaccuracies. Data sheet specifications and its information contained are intended to provide a product description only. "Typical" parameters which may be included on RECTRON data sheets and/ or specifications can and do vary in different applications and actual performance may vary over time. Rectron Inc does not assume any liability arising out of the application or use of any product or circuit.

Rectron products are not designed, intended or authorized for use in medical, life-saving implant or other applications intended for life-sustaining or other related applications where a failure or malfunction of component or circuitry may directly or indirectly cause injury or threaten a life without expressed written approval of Rectron Inc. Customers using or selling Rectron components for use in such applications do so at their own risk and shall agree to fully indemnify Rectron Inc and its subsidiaries harmless against all claims, damages and expenditures.

Mouser Electronics

Authorized Distributor

Click to View Pricing, Inventory, Delivery & Lifecycle Information:

[Rectron:](#)

[FM4752W-W](#) [FM4745W-W](#) [FM4744W-W](#) [FM4761W-W](#) [FM4735W-W](#) [FM4755W-W](#) [FM4739W-W](#) [FM4746W-W](#)
[FM4737W-W](#) [FM4738W-W](#)