



PARTS TABLE							
AGC		LEGACY, FOR SHORT BURST REMOTE CONTROLS (AGC1)		NOISY ENVIRONMENTS AND SHORT BURSTS (AGC3)		VERY NOISY ENVIRONMENTS AND SHORT BURSTS (AGC5)	
Carrier frequency	30 kHz	TSOP34130	TSOP32130	TSOP34330	TSOP32330	TSOP34530	TSOP32530
	33 kHz	TSOP34133	TSOP32133	TSOP34333	TSOP32333	TSOP34533	TSOP32533
	36 kHz	TSOP34136	TSOP32136	TSOP34336 (1)(6)	TSOP32336 (1)	TSOP34536	TSOP32536
	38 kHz	TSOP34138	TSOP32138	TSOP34338 (2)(3)(4)(5)	TSOP32338 (2)(3)(4)(5)	TSOP34538	TSOP32538
	40 kHz	TSOP34140	TSOP32140	TSOP34340	TSOP32340	TSOP34540	TSOP32540
	56 kHz	TSOP34156	TSOP32156	TSOP34356	TSOP32356	TSOP34556	TSOP32556
Package		Mold					
Pinning		1 = OUT, 2 = GND, 3 = V <sub>S</sub>	1 = OUT, 2 = V <sub>S</sub> , 3 = GND	1 = OUT, 2 = GND, 3 = V <sub>S</sub>	1 = OUT, 2 = V <sub>S</sub> , 3 = GND	1 = OUT, 2 = GND, 3 = V <sub>S</sub>	1 = OUT, 2 = V <sub>S</sub> , 3 = GND
Dimensions (mm)		6.0 W x 6.95 H x 5.6 D					
Mounting		Leaded					
Application		Remote control					
Best choice for		(1) MCIR (2) Mitsubishi (3) RECS-80 Code (4) r-map (5) XMP-1, XMP-2 (6) RCMM					
Special options		<ul style="list-style-type: none"> <li>Narrow optical filter: <a href="http://www.vishay.com/doc?81590">www.vishay.com/doc?81590</a></li> <li>Wide optical filter: <a href="http://www.vishay.com/doc?82726">www.vishay.com/doc?82726</a></li> <li>Low voltage option: <a href="http://www.vishay.com/doc?82382">www.vishay.com/doc?82382</a></li> </ul>					

ABSOLUTE MAXIMUM RATINGS				
PARAMETER	TEST CONDITION	SYMBOL	VALUE	UNIT
Supply voltage		V <sub>S</sub>	-0.3 to +6	V
Supply current		I <sub>S</sub>	3	mA
Output voltage		V <sub>O</sub>	-0.3 to (V <sub>S</sub> + 0.3)	V
Output current		I <sub>O</sub>	5	mA
Junction temperature		T <sub>j</sub>	100	°C
Storage temperature range		T <sub>stg</sub>	-25 to +85	°C
Operating temperature range		T <sub>amb</sub>	-25 to +85	°C
Power consumption	T <sub>amb</sub> ≤ 85 °C	P <sub>tot</sub>	10	mW
Soldering temperature	t ≤ 10 s, 1 mm from case	T <sub>sd</sub>	260	°C

Note

- Stresses beyond those listed under “Absolute Maximum Ratings” may cause permanent damage to the device. This is a stress rating only and functional operation of the device at these or any other conditions beyond those indicated in the operational sections of this specification is not implied. Exposure to absolute maximum rating conditions for extended periods may affect the device reliability

ELECTRICAL AND OPTICAL CHARACTERISTICS (T <sub>amb</sub> = 25 °C, unless otherwise specified)						
PARAMETER	TEST CONDITION	SYMBOL	MIN.	TYP.	MAX.	UNIT
Supply current	E <sub>v</sub> = 0, V <sub>S</sub> = 3.3 V	I <sub>SD</sub>	0.27	0.35	0.45	mA
	E <sub>v</sub> = 40 klx, sunlight	I <sub>SH</sub>	-	0.45	-	mA
Supply voltage		V <sub>S</sub>	2.5	-	5.5	V
Transmission distance	E <sub>v</sub> = 0, test signal see Fig. 1, IR diode TSAL6200, I <sub>F</sub> = 50 mA	d	-	30	-	m
Output voltage low	I <sub>OSL</sub> = 0.5 mA, E <sub>e</sub> = 0.7 mW/m <sup>2</sup> , test signal see Fig. 1	V <sub>OSL</sub>	-	-	100	mV
Minimum irradiance	Pulse width tolerance: t <sub>pi</sub> - 5/f <sub>o</sub> < t <sub>po</sub> < t <sub>pi</sub> + 6/f <sub>o</sub> , test signal see Fig. 1	E <sub>e min.</sub>	-	0.08	0.15	mW/m <sup>2</sup>
Maximum irradiance	t <sub>pi</sub> - 5/f <sub>o</sub> < t <sub>po</sub> < t <sub>pi</sub> + 6/f <sub>o</sub> , test signal see Fig. 1	E <sub>e max.</sub>	30	-	-	W/m <sup>2</sup>
Directivity	Angle of half transmission distance	φ <sub>1/2</sub>	-	± 45	-	°



**TYPICAL CHARACTERISTICS** ( $T_{amb} = 25\text{ }^{\circ}\text{C}$ , unless otherwise specified)

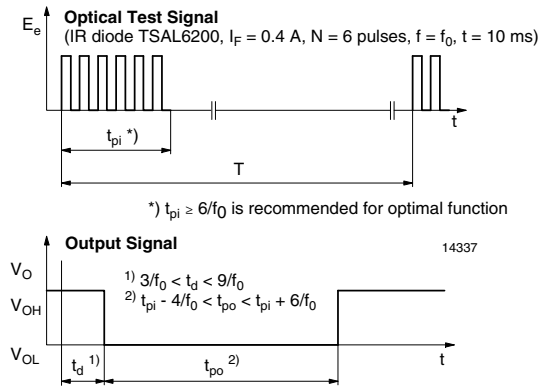

Fig. 1 - Output Active Low

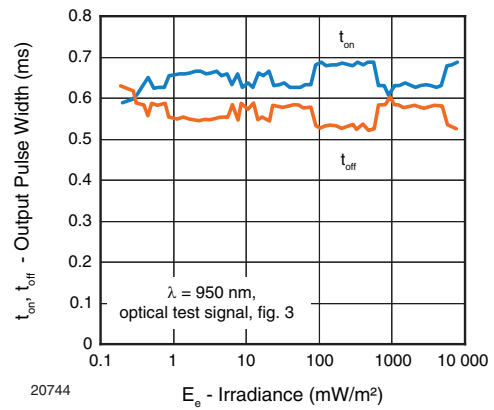

Fig. 4 - Output Pulse Diagram

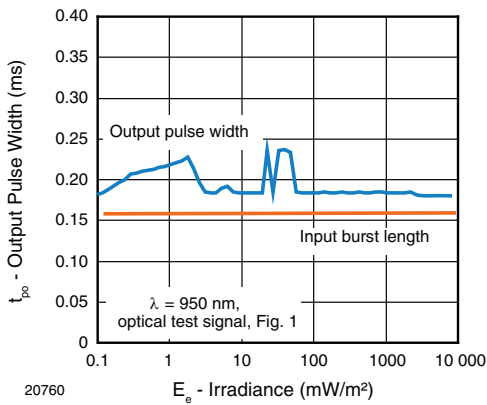

Fig. 2 - Pulse Length and Sensitivity in Dark Ambient

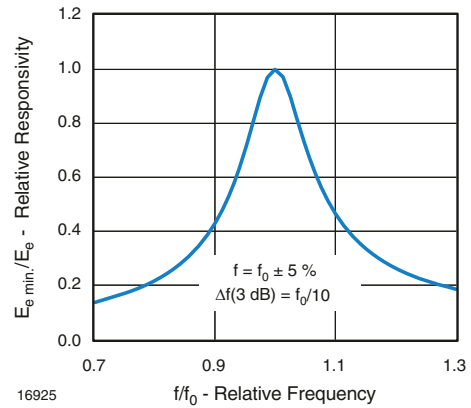

Fig. 5 - Frequency Dependence of Responsivity

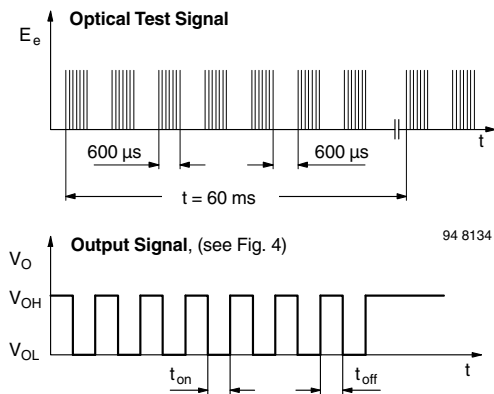

Fig. 3 - Output Function

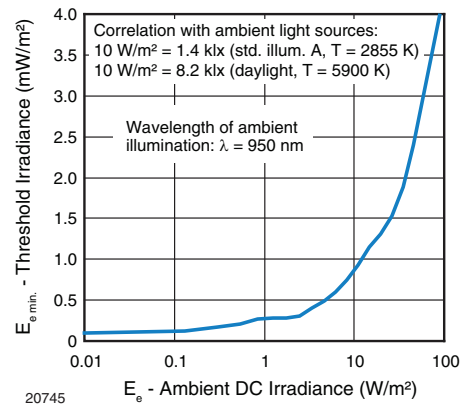

Fig. 6 - Sensitivity in Bright Ambient

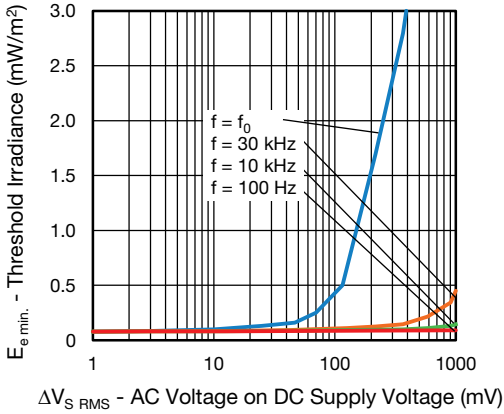

Fig. 7 - Sensitivity vs. Supply Voltage Disturbances

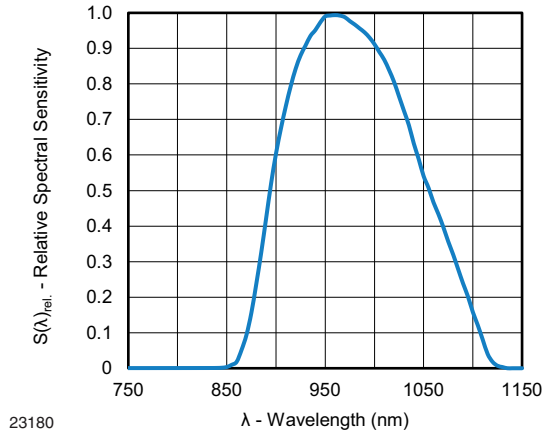

Fig. 10 - Relative Spectral Sensitivity vs. Wavelength

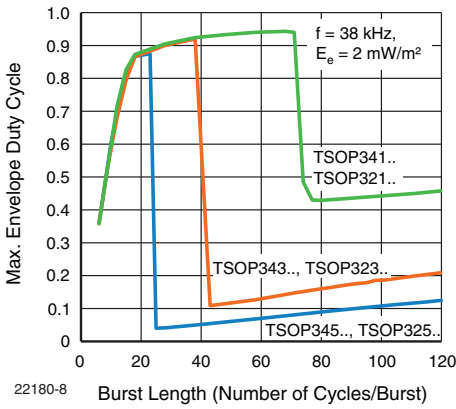

Fig. 8 - Maximum Envelope Duty Cycle vs. Burst Length

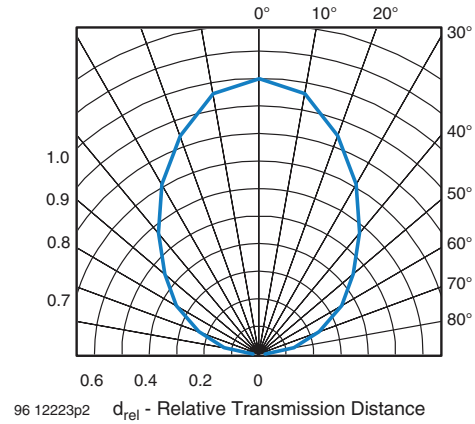

Fig. 11 - Horizontal Directivity

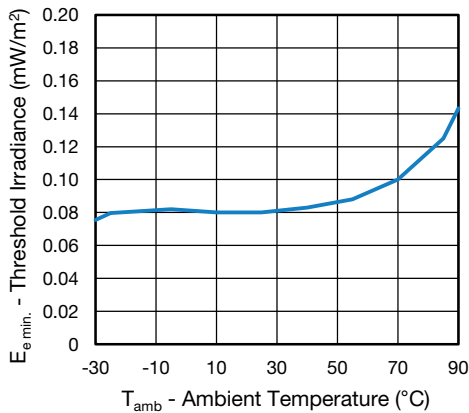

Fig. 9 - Sensitivity vs. Ambient Temperature

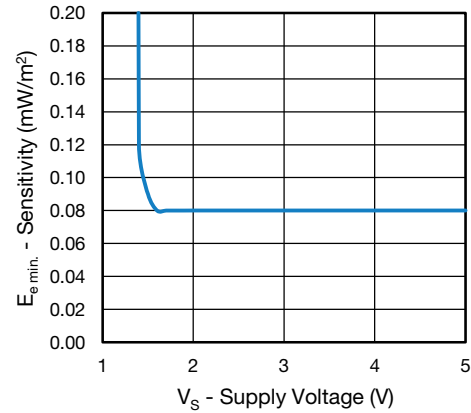

Fig. 12 - Sensitivity vs. Supply Voltage



SUITABLE DATA FORMAT

This series is designed to suppress spurious output pulses due to noise or disturbance signals. The devices can distinguish data signals from noise due to differences in frequency, burst length, and envelope duty cycle. The data signal should be close to the device's band-pass center frequency (e.g. 38 kHz) and fulfill the conditions in the table below.

When a data signal is applied to the product in the presence of a disturbance, the sensitivity of the receiver is automatically reduced by the AGC to insure that no spurious pulses are present at the receiver's output. Some examples which are suppressed are:

- DC light (e.g. from tungsten bulbs sunlight)
- Continuous signals at any frequency
- Strongly or weakly modulated patterns from fluorescent lamps with electronic ballasts (see Fig. 13 or Fig. 14).

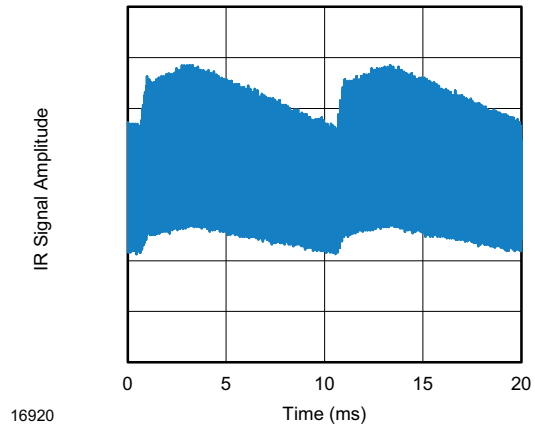

Fig. 13 - IR Disturbance from Fluorescent Lamp With Low Modulation

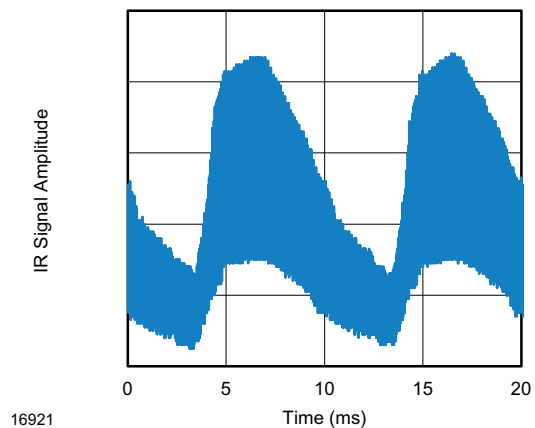

Fig. 14 - IR Disturbance from Fluorescent Lamp With High Modulation

	TSOP341..., TSOP321..	TSOP343..., TSOP323..	TSOP345..., TSOP325..
Minimum burst length	6 cycles/burst	6 cycles/burst	6 cycles/burst
After each burst of length A gap time is required of	6 to 70 cycles ≥ 10 cycles	6 to 35 cycles ≥ 10 cycles	6 to 24 cycles ≥ 10 cycles
For bursts greater than a minimum gap time in the data stream is needed of	70 cycles > 1.2 x burst length	35 cycles > 6 x burst length	24 cycles > 25 ms
Maximum number of continuous short bursts/second	2000	2000	2000
MCIR code	Yes	Preferred	Yes
XMP-1, XMP-2 code	Yes	Preferred	Yes
Suppression of interference from fluorescent lamps	Mild disturbance patterns are suppressed (example: signal pattern of Fig. 13)	Complex disturbance patterns are suppressed (example: signal pattern of Fig. 14)	Critical disturbance patterns are suppressed, e.g. highly dimmed LCDs

Notes

- For data formats with long bursts (more than 10 carrier cycles) please see the datasheet for TSOP348..., TSOP344..., TSOP322..., TSOP324..



PACKAGE DIMENSIONS in millimeters

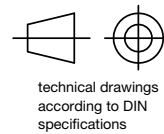
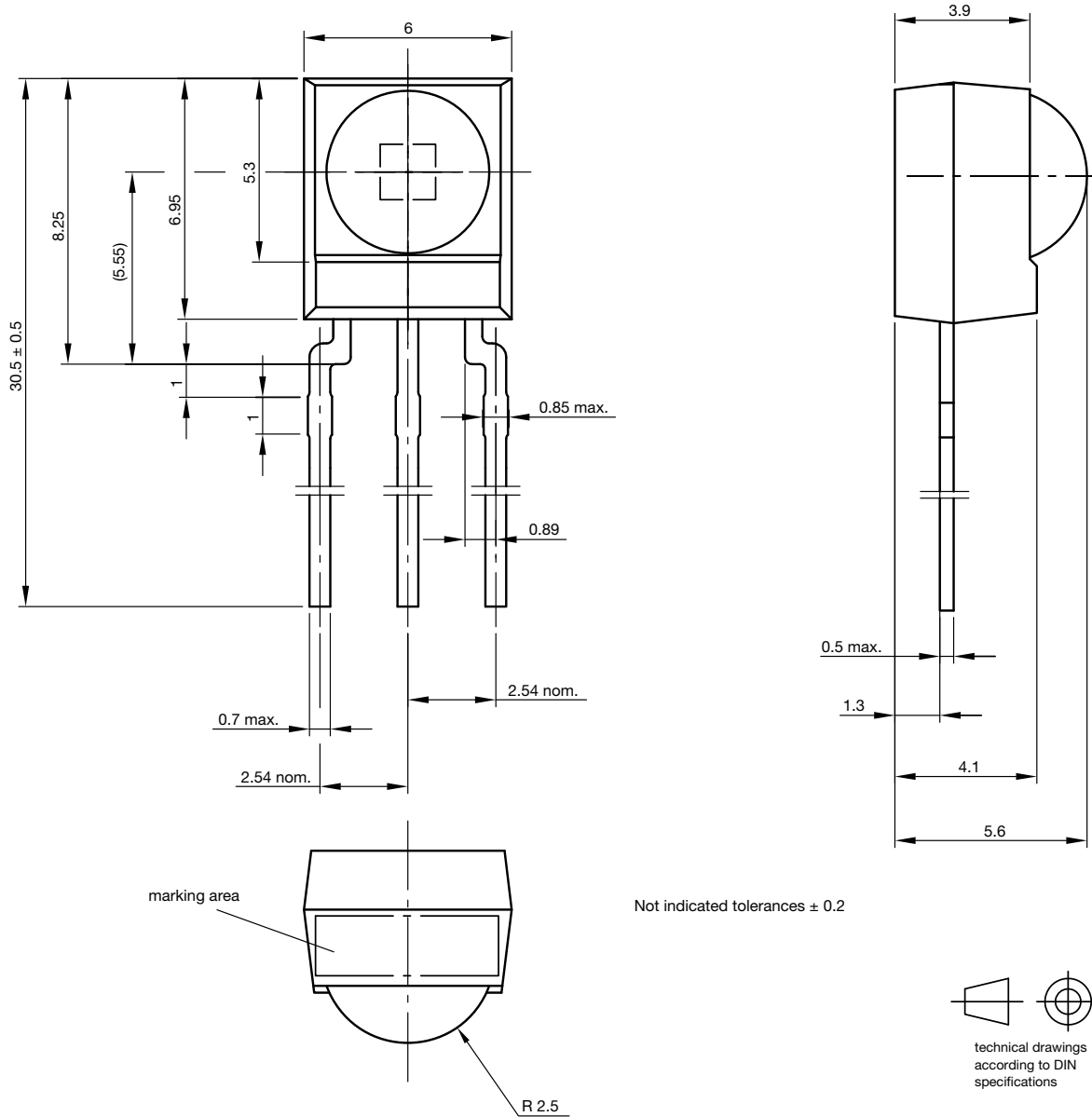

Drawing-No.: 6.550-5169.01-4  
Issue: 9; 03.11.10  
13655



## Disclaimer

ALL PRODUCT, PRODUCT SPECIFICATIONS AND DATA ARE SUBJECT TO CHANGE WITHOUT NOTICE TO IMPROVE RELIABILITY, FUNCTION OR DESIGN OR OTHERWISE.

Vishay Intertechnology, Inc., its affiliates, agents, and employees, and all persons acting on its or their behalf (collectively, "Vishay"), disclaim any and all liability for any errors, inaccuracies or incompleteness contained in any datasheet or in any other disclosure relating to any product.

Vishay makes no warranty, representation or guarantee regarding the suitability of the products for any particular purpose or the continuing production of any product. To the maximum extent permitted by applicable law, Vishay disclaims (i) any and all liability arising out of the application or use of any product, (ii) any and all liability, including without limitation special, consequential or incidental damages, and (iii) any and all implied warranties, including warranties of fitness for particular purpose, non-infringement and merchantability.

Statements regarding the suitability of products for certain types of applications are based on Vishay's knowledge of typical requirements that are often placed on Vishay products in generic applications. Such statements are not binding statements about the suitability of products for a particular application. It is the customer's responsibility to validate that a particular product with the properties described in the product specification is suitable for use in a particular application. Parameters provided in datasheets and / or specifications may vary in different applications and performance may vary over time. All operating parameters, including typical parameters, must be validated for each customer application by the customer's technical experts. Product specifications do not expand or otherwise modify Vishay's terms and conditions of purchase, including but not limited to the warranty expressed therein.

Hyperlinks included in this datasheet may direct users to third-party websites. These links are provided as a convenience and for informational purposes only. Inclusion of these hyperlinks does not constitute an endorsement or an approval by Vishay of any of the products, services or opinions of the corporation, organization or individual associated with the third-party website. Vishay disclaims any and all liability and bears no responsibility for the accuracy, legality or content of the third-party website or for that of subsequent links.

Except as expressly indicated in writing, Vishay products are not designed for use in medical, life-saving, or life-sustaining applications or for any other application in which the failure of the Vishay product could result in personal injury or death. Customers using or selling Vishay products not expressly indicated for use in such applications do so at their own risk. Please contact authorized Vishay personnel to obtain written terms and conditions regarding products designed for such applications.

No license, express or implied, by estoppel or otherwise, to any intellectual property rights is granted by this document or by any conduct of Vishay. Product names and markings noted herein may be trademarks of their respective owners.

# Mouser Electronics

Authorized Distributor

Click to View Pricing, Inventory, Delivery & Lifecycle Information:

[Vishay:](#)

[TSOP32338SS1V](#) [TSOP32137](#) [TSOP34338SS1F](#) [TSOP34336SS1F](#) [TSOP32136SS1F](#) [TSOP32138SS1F](#)  
[TSOP32338SS1F](#) [TSOP34156SS1F](#) [TSOP32336SS1FBS12Z](#)