



**FUNCTIONAL BLOCK DIAGRAM**

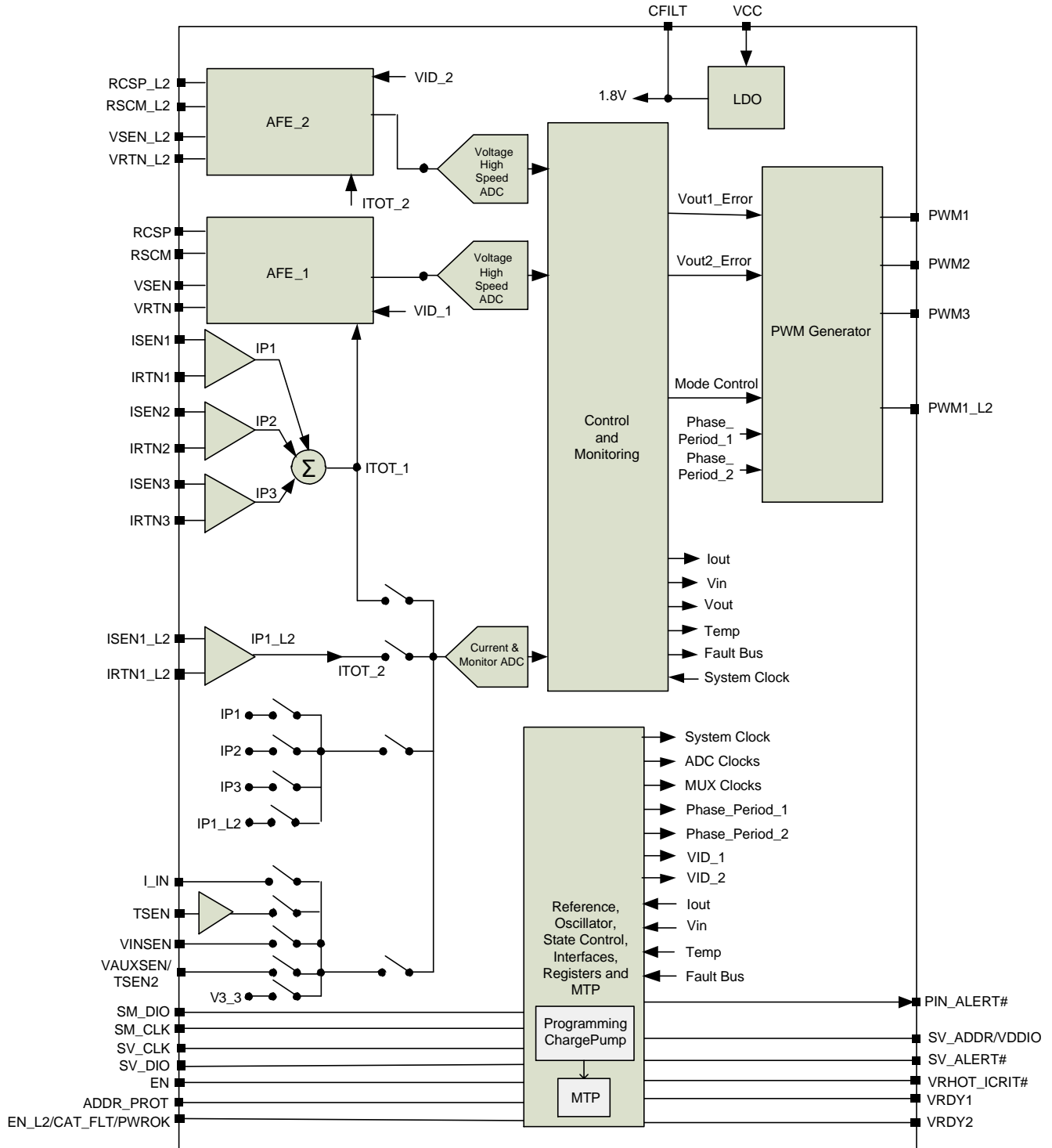

Figure 2: IR35204 Block Diagram

**TYPICAL APPLICATION DIAGRAM**

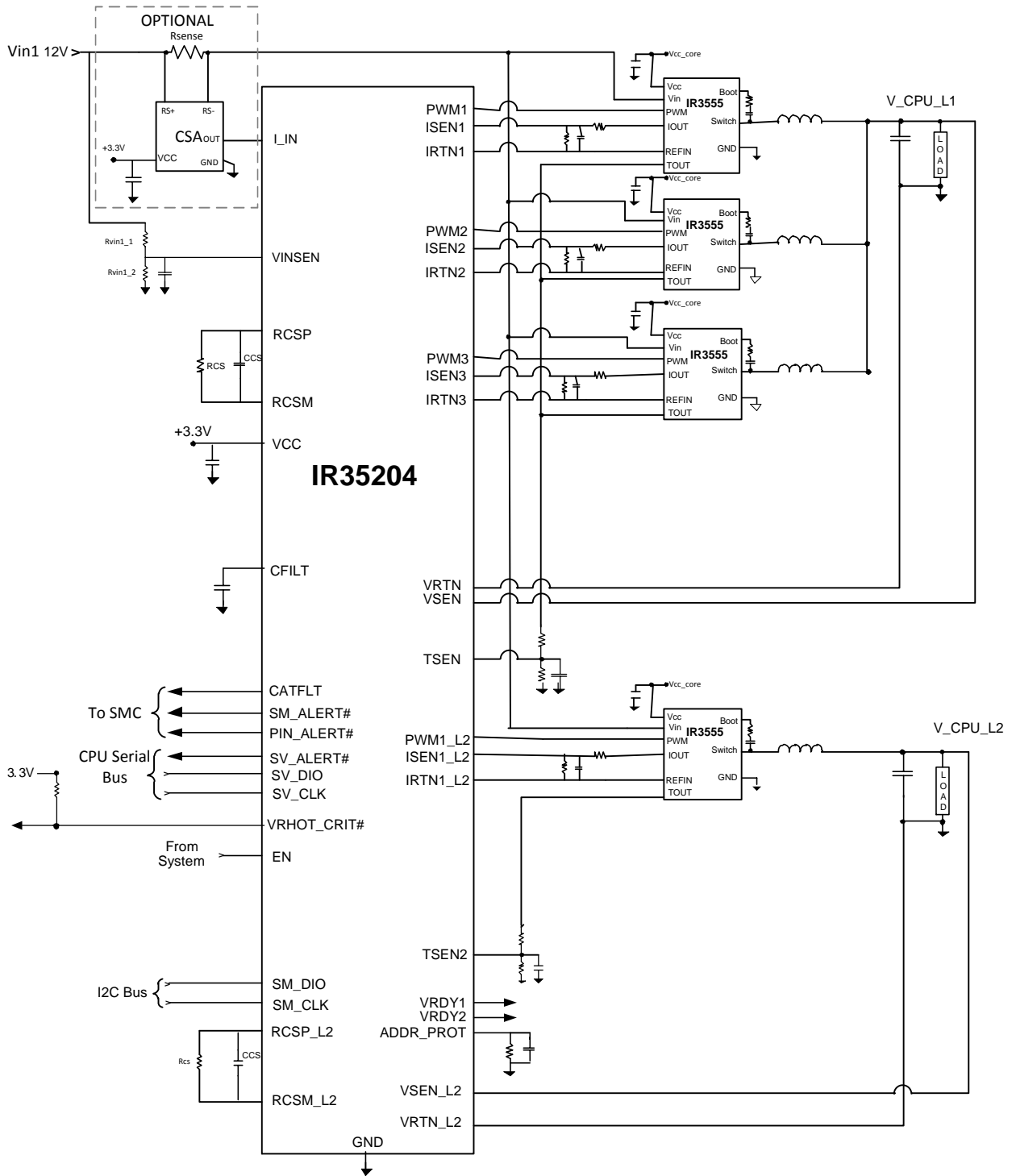

Figure 3: VR using IR35204 Controller and IR3555 PowIR Stage in 3+1 Configuration

## PIN DESCRIPTIONS

PIN#	PIN NAME	TYPE	PIN DESCRIPTION
1	RCSM	A [O]	<b>Resistor Current Sense Minus Loop#1.</b> This pin is connected to an external network to set the load line slope, bandwidth and temperature compensation for Loop 1.
2	VRDY2	D [O]	<b>Voltage Regulator Ready Output (Loop #2).</b> Open-drain output that asserts high when the VR has completed soft-start to Loop #2 boot voltage. Pull-up to an external voltage through a resistor.
3	VSEN	A [I]	<b>Voltage Sense Input Loop#1.</b> This pin is connected directly to the VR output voltage of Loop #1 at the load and should be routed differentially with VRTN.
4	VRTN	A [I]	<b>Voltage Sense Return Input Loop#1.</b> This pin is connected directly to Loop#1 ground at the load and should be routed differentially with VSEN.
5	I_IN	A [I]	<b>I in.</b> Input current signal that ranges from 0 to 1Vdc indicating a maximum input current of 62.5A.
6	TSEN1	A [I]	<b>Temperature Sense Input Loop 1.</b> An NTC network or the temperature reporting output from an IR PowIRstage can be connected to this pin to measure temperature for VRHOT and OTP shutdown. When connected to the IR PowIRstage's temperature output; the scaled input voltage to the controller needs to be at a gain of 4.88mV per degC and an offset of 0.365 Vdc so the controller can correctly report temperature. Typically a 10kohm and 6.39kohm resistive divider is used to accomplish the scaling between the power stage and the controller.
7	CFILT	A [O]	<b>1.8V Decoupling.</b> A 1 $\mu$ F capacitor on this pin provides decoupling for the internal 1.8V supply.
8	VRDY1	D [O]	<b>Voltage Regulator Ready Output (Loop #1).</b> Open-drain output that asserts high when the VR has completed soft-start to Loop #1 boot voltage. Pull-up to an external voltage through a resistor.
9	EN_L2 PWROK CAT_FLT	D[I] D[I] D[O]	<b>Enable Input for Loop #2.</b> This pin may be configured as an Enable input for loop #2.
			<b>Power OK Input (AMD).</b> An input that when low indicates to return to the Boot voltage and when high indicates to use the SVI bus.
			<b>Catastrophic Fault Output Pin.</b> This pin may be used as a Catastrophic Fault CMOS Output Pin that is driven to VCC under output OVP, NVM CRC errors or a TSEN fault input.
10	VINSEN	A [I]	<b>Voltage Sense Input.</b> This is used to detect and measure a valid input supply voltage (typically 4.5V-13.2V) to the VR.
11	SV_ADDR VDDIO	A[I] A[P]	<b>Serial VID Address.</b> If present, a resistor to ground sets the offset to the SVID address set in NVM. If not, the value stored in NVM is used. Requires a 0.01 $\mu$ F to ground for noise filtering.
			<b>VDDIO Input (AMD).</b> This pin provides the voltage to which the SVT line and the SVD Acknowledge are driven high.
12	SV_ALERT# SVT	D [O]	<b>Serial VID ALERT# (INTEL).</b> SVID ALERT# is pulled low by the controller to alert the CPU of new VR/12/12.5 Status. Pull-up to an external voltage through a resistor.
			<b>SVI Telemetry Output (AMD).</b> Telemetry and VOTF information output by the IR35204
13	SV_CLK	D [I]	<b>Serial VID Clock Input.</b> Clock input driven by the CPU Master.
14	SV_DIO	D [B]	<b>Serial VID Data I/O.</b> Is a bi-directional serial line over which the CPU Master issues commands to slave/s and receives data back.
15	VRHOT_ICRIT#	D [O]	<b>VRHOT_ICRIT# Output.</b> Active low alert pin that can be programmed to assert if temperature or average load current exceeds user-definable thresholds. Pull-up to an external voltage through a resistor.
16	EN	D [I]	<b>VR Enable Input.</b> ENABLE is used to power-on the regulator, provided Vin and Vcc are present. ENABLE is not pulled up in the controller. The polarity of the chip enable function is bit-settable to either an active high or an active low configuration. When the controller is disabled, the controller de-asserts VR READY and shuts down the regulator. ENABLE pin cannot be left floating. ENABLE pin must be pulled high or low.
17	ADDR_PROT	D [B]/	<b>Bus Address &amp; I2C Bus Protection.</b> A resistor to ground on this pin sets the offset to the NVM value of the I2C address if configured to do so. Subsequently, this pin becomes a logic input to enable or disable communication on the I2C bus when protection is enabled. Requires a 0.01 $\mu$ F to ground for noise filtering.
18	SM_ALERT#	D [O]	<b>SMBus/PMBus Alert Line.</b> Active low alert pin to indicate that the regulator status has changed. Requires a pull-up. Ground if not used.

PIN#	PIN NAME	TYPE	PIN DESCRIPTION
19	SM_DIO	D [B]	<b>Serial Data Line I/O.</b> I2C/SMBus/PMBus bi-directional serial data line. Ground if not used.
20	SM_CLK	D [I]	<b>Serial Clock Line Input.</b> I2C/SMBus/PMBus clock input. The interface is rated to 1 MHz. Ground if not used.
21	PIN_ALERT#	D [O]	<b>PIN_ALERT# Output.</b> Active low alert pin that can be programmed to assert if the input power exceeds user-defined threshold. Pull-up to an external voltage through a resistor.
22	TSEN2 /VAUXSEN	A [I] A [I]	<b>Temperature Sense Input Loop #2.</b> An NTC network or the temperature reporting output from an IR PowIRstage can be connected to this pin to measure temperature for VRHOT. Float if not used.
			<b>Auxiliary Voltage Sense Input.</b> Monitors an additional power supply to ensure that both the IR35204 Vcc and other voltages (such as VCC to the driver) are operational. Float if not used.
23 – 25	PWM1 – PWM3	A [O]	<b>Phase 1-3 Pulse Width Modulation Outputs.</b> PWM signal pin which is connected to the input of an external MOSFET gate driver. The power-up state is high-impedance until ENABLE goes active.
26	PWM1_L2	A [O]	<b>Loop 2 Phase 1 Pulse Width Modulation Output.</b> PWM signal pin which is connected to the input of an external MOSFET gate driver. The power-up state is high-impedance until ENABLE goes active. Float if not used.
27	VRTN_L2	A [I]	<b>Voltage Sense Return Input Loop#2.</b> This pin is connected directly to Loop#2 ground at the load and should be routed differentially with VSEN_L2. Connect to GND if not used.
28	VSEN_L2	A [I]	<b>Voltage Sense Input Loop#2.</b> This pin is connected directly to the VR output voltage of Loop #2 at the load and should be routed differentially with VRTN_L2. Connect to GND if not used.
29	VCC	A [P]	<b>Input Supply Voltage.</b> 3.3V supply to power the device.
30	RCSM_L2	A [O]	<b>Resistor Current Sense Minus Loop#2.</b> This pin is connected to an external network to set the load line slope, bandwidth and temperature compensation for Loop #2. Connect to pin 31 with 10K resistor if not used
31	RCSP_L2	A [O]	<b>Resistor Current Sense Positive Loop#2.</b> This pin is connected to an external network to set the load line slope, bandwidth and temperature compensation for Loop #2. Connect to pin 30 with 10K resistor if not used
32	ISEN 1_L2	A [I]	<b>Loop 2 Phase 1 Current Sense Input.</b> Loop 2 Phase 1 sensed current input (+). GND if not used.
33	IRTN 1_L2	A [I]	<b>Loop 2 Phase 1 Current Sense Return Input.</b> Loop 2 Phase 1 sensed current input return (-). GND if not used.
34	ISEN 3	A [I]	<b>Phase 3 Current Sense Input.</b> Phase 3 sensed current input (+).GND if not used.
35	IRTN 3	A [I]	<b>Phase 3 Current Sense Return Input.</b> Phase 3 sensed current input return (-).GND if not used.
36	ISEN 2	A [I]	<b>Phase 2 Current Sense Input.</b> Phase 2 sensed current input (+).GND if not used.
37	IRTN 2	A [I]	<b>Phase 2 Current Sense Return Input.</b> Phase 2 sensed current input return (-).GND if not used.
38	ISEN 1	A [I]	<b>Phase 1 Current Sense Input.</b> Phase 1 sensed current input (+).GND if not used.
39	IRTN 1	A [I]	<b>Phase 1 Current Sense Return Input.</b> Phase 1 sensed current input return (-).GND if not used.
40	RCSP	A [O]	<b>Resistor Current Sense Positive Loop#1.</b> This pin is connected to an external network to set the load line slope, bandwidth and temperature compensation for Loop 1.
41 (PAD)	GND		<b>Ground.</b> Ground reference for the IC. The large metal pad on the bottom must be connected to Ground.

**Note 1:** A - Analog; D – Digital; [I] – Input; [O] – Output; [B] – Bi-directional; [P] - Power

## ABSOLUTE MAXIMUM RATINGS

Supply Voltage (VCC)	GND-0.3V to 4.0V
RCSPx, RCSMx	0 to 2.2V
VSEN, VRTN, ISENx, IRTNx	GND-0.2V to VCC + 0.3V
CFILT, VINSEN, I_IN	GND-0.2V to 2.2V
TSENx	GND-0.3V to VCC
SV_CLK, SV_DIO, SV_ALERT#, SV_ADDR	GND-0.3V to VCC
VRDYx, ENx, ADDR_PROT, VRHOT_ICRIT#, PIN_ALERT#	GND-0.3V to VCC
PWMx,	GND-0.3V to 4.1V
SM_DIO, SM_CLK, SM_ALERT#	GND-0.3V to 5.5V
<b>ESD Rating</b>	
Human Body Model	2000V
Machine Model	200V
Charge Device Model	1000V
<b>Thermal Information</b>	
Thermal Resistance ( $\theta_{JA}$ & $\theta_{JC}$ ) <sup>1</sup>	29°C/W & 3°C/W
Maximum Operating Junction Temperature	-40°C to +125°C
Maximum Storage Temperature Range	-65°C to +150°C
Maximum Lead Temperature (Soldering 10s)	300°C

**Note:** 1.  $\theta_{JA}$  is measured with the component mounted on a high effective thermal conductivity test board in free air.

Stresses beyond those listed under “Absolute Maximum Ratings” may cause permanent damage to the device. These are stress ratings only and functional operation of the device at these or any other conditions beyond those indicated in the operational sections of the specifications are not implied.

## ELECTRICAL SPECIFICATIONS

### RECOMMENDED OPERATING CONDITIONS FOR RELIABLE OPERATION WITH MARGIN

Recommended Operating Ambient Temperature Range	-40°C to 85°C
Supply Voltage Range	+2.90V to +3.63V

The electrical characteristics table lists the spread of values guaranteed within the recommended operating conditions. Typical values represent the median values, which are related to 25°C.

### ELECTRICAL CHARACTERISTICS

PARAMETER	SYMBOL	CONDITIONS	MIN	TYP	MAX	UNIT
<b>Supply</b>						
	<b>VCC/GND</b>					
Supply Voltage	$V_{cc}$		2.90	3.3	3.63	V
Supply Current	$I_{vcc}$	No PWM switching	-	48	-	mA
3.3V UVLO Turn-on Threshold			-	2.80	2.90	V
3.3V UVLO Turn-off Threshold			2.60	2.70	-	V
<b>Input Voltage (4.5V-13.2V) Sense Input</b>						
	<b>VINSEN</b>					
Input Impedance			1	-	-	MΩ
Input Range	V12	With 14:1 divider	0	0.857	1.1	V
UVLO Turn-on Programmable Range <sup>1</sup>		With 14:1 divider	-	4.5 – 13.2	-	V
UVLO Turn-off Programmable Range <sup>1</sup>		With 14:1 divider	-	4.5 – 13.2	-	V
OVP Threshold (if enabled) <sup>1</sup>			14.3	14.6	14.9	V
<b>AUX Voltage Sense Input</b>						
	<b>VAUXSEN</b>					
Input Impedance <sup>1</sup>			-	1	-	MΩ
UVLO Turn-on Threshold <sup>1</sup>		VAUXSEN_on	0.642	0.664	0.686	mV
UVLO Turn-off Threshold <sup>1</sup>		VAUXSEN_off	0.564	0.586	0.608	mV
<b>Reference Voltage and DAC</b>						
VBoot Voltage Range		Intel® VR12.5, VR12 and IMVP8 mode, and AMD SVI2	Meets spec			V
System Accuracy (0 to 85°C ambient)		VID = 2.005–3.04V	-1.1	-	1.1	%VID
		VID = 1.0V–2.0V	-0.5	-	0.5	%VID
		VID = 0.8 – 0.995V	-5	-	5	mV
		VID = 0.25 – 0.795V	-8	-	8	mV
System Accuracy (-40°C to 125°C junction)		VID = 2.005–3.04V	-1.65	-	1.65	%VID
		VID = 1.0V–2.0V	-0.75	-	0.75	%VID
		VID = 0.8 – 0.995V	-7.5	-	7.5	mV
		VID = 0.25 – 0.795V	-12	-	12	mV
<b>Oscillator &amp; PWM Generator</b>						
Internal Oscillator <sup>1</sup>			-	96	-	MHz
Frequency Accuracy		0°C to 85°C	-2.5	-	2.5	%
Frequency Accuracy		-40°C to 125°C	-5	-	+5	%
PWM Frequency Range <sup>1</sup>			194	-	2000	kHz

PARAMETER	SYMBOL	CONDITIONS	MIN	TYP	MAX	UNIT
PWM Resolution <sup>1</sup>			-	163	-	ps
<b>NTC Temperature Sense</b>	<b>TSEN_NTC</b>					
Output Current		For TSEN = 0 to 1.2V	96	100	104	μA
Accuracy <sup>1</sup>		at 100°C (ideal NTC)	96	-	104	°C
<b>Tout Temperature Sense</b>	<b>TSEN_IR3555</b>					
Input Voltage		For TSEN = 0 to 1.2V	-	4.88	-	mV/°C
Offset Voltage			-	0.365	-	Vdc
Fault Threshold			1.45			Vdc
Divider Ratio to interface IR3555 to IR35204			-	1:1.64	-	
<b>Digital Inputs – Low Vth Type 1</b>	<b>EN(_L2) (Intel), VRHOT_ICRIT# (during PoR),</b>					
Input High Voltage			0.7	-	-	V
Input Low Voltage			-	-	0.35	V
Input Leakage Current		Vpad = 0 to 2V	-	-	±5	μA
<b>Digital Inputs – Low Vth Type 2</b>	<b>SV_CLK, SV_DIO</b>					
Input High Voltage			0.65	-	-	V
Input Low Voltage			-	-	0.45	V
Hysteresis			-	95	-	mV
Input Leakage Current		Vpad = 0 to 2V	-	-	±1	μA
<b>Digital Inputs – LVTTL</b>	<b>SM_DIO, SM_CLK, EN(_L2), ADDR_PROT</b>					
Input High Voltage			2.1	-	-	V
Input Low Voltage			-	-	0.8	V
Input Leakage		Vpad = 0 to 3.6V	-	-	±1	μA
<b>Remote Voltage Sense Inputs</b>	<b>VSENx, VRTNx</b>					
VSEN Input Current		VCPU = 0.5V to 3.04V	-	-25 to +100	-	μA
VRTN Input Current			-	-50	-	μA
Differential Input Voltage Range <sup>1</sup>		VRTN = ±100mV	-	0 to 3.04	-	V
VRTN Input CM Voltage <sup>1</sup>			-	-100 to 100	-	mV
<b>Remote Current Sense Inputs</b>	<b>ISENx/IRTNx</b>					
Voltage Range <sup>1</sup>			-	-0.1 to VCC - 0.65	-	V
<b>Input Current Sense Input</b>	<b>I_IN</b>					
Voltage Range			-	0 to 1.25	-	V
<b>Analog Address/Level Inputs</b>	<b>ADDR_PROT,SV_ADDR</b>					
Output Current <sup>1</sup>		Vpad = 0 to 1.2V	96	100	104	μA



PARAMETER	SYMBOL	CONDITIONS	MIN	TYP	MAX	UNIT
<b>CMOS Outputs — 3.3V</b>		<b>CAT_FLT</b>				
Output High Voltage		I <sub>oh</sub> = -20mA	V <sub>CC</sub> – 0.4	-	-	V
Output Low Voltage		I <sub>ol</sub> = 20mA	-	-	0.4	V
<b>Open-Drain Outputs – 4mA Drive</b>		<b>VRDY, SM_DIO, SM_ALERT#</b>				
Output Low Voltage		4mA	-	-	0.3	V
Output Leakage		V <sub>pad</sub> = 0 to 3.6V	-	-	±5	μA
<b>Open-Drain Outputs – 20mA Drive</b>		<b>VR_HOT_ICRIT#, SV_DIO, SV_ALERT#, PIN_ALERT#</b>				
Output Low Voltage <sup>1</sup>		I = 20mA	-	-	0.26	V
On Resistance <sup>1</sup>		I = 20mA	7	9	13	Ω
Tri-State Leakage	I <sub>leak</sub>	V <sub>pad</sub> = 0 to 3.6V	-	-	±5	μA
<b>PWM I/O</b>		<b>PWMx</b>				
Output Low Voltage (Tri-state mode)		I = -4mA	-	-	0.4	V
Output High Voltage (Tri-State mode)		I = +4mA	2.9	-	-	V
Tri-State Leakage		loop_x_pwm_en_ats = 0, V <sub>pad</sub> = 0 to V <sub>cc</sub>	-	-	±1	μA
<b>PWM Auto-Detect Inputs (when 3.3V V<sub>cc</sub> is applied) – if enabled</b>						
Input Voltage High			0.7	-	-	V
Input Voltage Low			-	-	0.35	V
<b>AMD SVI2 Bus</b>						
T <sub>period</sub> (SVC Period) <sup>1</sup>	SVC		47.6		10,000	nSec
SVI2 SVC Frequency <sup>1</sup>	SVC		0.1	20.0	21.0	MHz
<b>I2C/PMBus &amp; Reporting</b>						
Bus Speed <sup>1</sup>		Normal	-	100	-	kHz
		Fast	-	400	-	kHz
		Maximum	-	1000	-	kHz
I <sub>out</sub> , V <sub>out</sub> , I <sub>in</sub> , V <sub>in</sub> , Pin and Temperature Filter Rate <sup>1</sup>		Selectable (Selected Frequency applies to all parameters)	-	0.69, 1.39, 2.78, 5.55, 11.1, 22.2, 44.6, 89.5	-	Hz
I <sub>out</sub> Update Rate <sup>1</sup>			-	250	-	kHz
V <sub>out</sub> Update Rate <sup>1</sup>			-	35.7	-	kHz
V <sub>in</sub> & Temperature Update Rate <sup>1</sup>			-	35.7	-	kHz
V <sub>in</sub> Range Reporting <sup>1</sup>		With 14:1 divider	-	0 to 13.2	-	V

PARAMETER	SYMBOL	CONDITIONS	MIN	TYP	MAX	UNIT
Vin Accuracy Reporting		With 1% resistors	-2	-	+2	%
Vin Resolution Reporting -PMBUS <sup>1</sup>			-	31.25	-	mV
Vin Resolution Reporting -I2C <sup>1</sup>			-	125	-	mV
Vout Range Reporting <sup>1</sup>			-	-	4	V
Vout Accuracy Reporting <sup>1</sup>		No load-line		±0.5		%
Vout Resolution Reporting-PMBUS <sup>1</sup>		Vout < 2V	-	1.95	-	mV
Vout Resolution Reporting-I2C <sup>1</sup>		Vout < 4V	-	15.6	-	mV
Iout Per Phase Range Reporting <sup>1</sup>			0	-	62	A
Iout Accuracy Reporting <sup>1</sup>		Maximum load, all phase active (based on DCR, NTC and # active phases)	-	±2	-	%
Loop1 Iout Resolution Reporting-PMBUS <sup>1</sup>		*0.5A if >255.75A	-	0.25*	-	A
Loop2 Iout Resolution Reporting-PMBUS <sup>1</sup>			-	0.25	-	A
Loop1 Iout Resolution Reporting-I2C <sup>1</sup>			-	1	-	A
Loop2 Iout Resolution Reporting-I2C <sup>1</sup>			-	0.5	-	A
Loop1 Iin Resolution Reporting-PMBUS <sup>1</sup>			-	31.25	-	mA
Loop2 Iin Resolution Reporting-PMBUS <sup>1</sup>			-	31.25	-	mA
Loop1 Iin Resolution Reporting-I2C <sup>1</sup>			-	0.125	-	A
Loop2 Iin Resolution Reporting-I2C <sup>1</sup>			-	0.0625	-	A
P_in Resolution Reporting-PMBUS <sup>1</sup>			-	0.5	-	W
P_out Resolution Reporting-PMBUS <sup>1</sup>			-	0.5	-	W
Temperature Range Reporting1		IR3555 mode	0	-	158	°C
Temperature Accuracy Reporting1		IR3555 mode	3.5	-	3.5	%
Temperature Range Reporting <sup>1</sup>			0	-	134	°C
Temperature Accuracy Reporting <sup>1</sup>		At 100°C, with ideal NTC	-4	-	4	%
Temperature Resolution Reporting <sup>1</sup>			-	1	-	°C
<b>Fault Protection</b>						
OVP Threshold During Start-up (until output reaches 1V)		Selectable	-	1.2, 1.275, 1.35, 2.5	-	V
OVP Operating Threshold <sup>1</sup> (programmable)		Relative to VID	-	50 to 400	-	mV
OVP Filter Delay <sup>1</sup>			-	160	-	ns
Output UVP Threshold <sup>1</sup> (programmable)		Relative to VID	-	50 to 400	-	mV

PARAMETER	SYMBOL	CONDITIONS	MIN	TYP	MAX	UNIT
Fast OCP Range (per phase) <sup>1</sup>			-	0 to 62	-	A
Fast OCP Filter Bandwidth <sup>1</sup>			-	60	-	kHz
Slow OCP Filter Bandwidth <sup>1</sup>		Selectable	-	0.69, 1.39, 2.78, 5.55, 11.1, 22.2, 44.6, 89.5	-	Hz
OCP System Accuracy <sup>1</sup>		System excluding DCR/sense resistor	-	±2	-	%
PIN_ALERT# Bandwidth				2000		Hz
VR_HOT Range <sup>1</sup>			-	64 to 127	-	°C
OTP Range <sup>1, 2</sup>		OTP Range (added to VR_HOT level)	-	0 to 31	-	°C
<b>Dynamic Phase Control</b>						
Current Filter Bandwidth <sup>1</sup>		For Phase drop	-	4	-	kHz
<b>Timing Information</b>						
Automatic Configuration from MTP <sup>1</sup>	$t_3-t_2$	3.3V ready to end of configuration	-	0.4		ms
Automatic Trim Time <sup>1</sup>	$t_4-t_3$		-	2		ms
EN Delay (to ramp start) <sup>1</sup>			-	3	-	µs
VID Delay (to ramp start) <sup>1</sup>		Loop bandwidth dependent	-	5	-	µs
VRDY Delay <sup>1</sup>		After reaching Boot voltage	-	20	-	µs

**Notes:**

<sup>1</sup> Guaranteed by design.

<sup>2</sup> OTP max setting with NTC TEMP SENSE is 134°C.

## GENERAL DESCRIPTION

The IR35204 is a flexible, dual-loop, digital multiphase PWM buck controller optimized to convert a 12V input supply to the core voltage required by Intel high performance microprocessors and DDR memory. It is easily configurable for 1 to 3 phases of operation on Loop #1 and 0 to 1 phase operation on Loop #2.

The unique partitioning of analog and digital circuits within the IR35204 provides the user with easy configuration capability while maintaining the required accuracy and performance. Access to on-chip Multiple Time Programming memory (MTP) to store the IR35204 configuration parameters enables power supply designers to optimize their designs without changing external components.

## OPERATING MODES

The IR35204 can be used for Intel® VR12, VR12.5, IMVP8 designs, AMD SVI2 and DDR Memory designs without significant changes to the external components (Bill of Materials). The required mode is selected in MTP and the pin-out, VID table and relevant functions are automatically configured. This greatly reduces time-to-market and eliminates the need to manage and inventory different PWM controllers.

## DIGITAL CONTROLLER & PWM

A linear Proportional-Integral-Derivative (PID) digital controller provides the loop compensation for system regulation. The digitized error voltage from the high-speed voltage error ADC is processed by the digital compensator. The digital PWM generator uses the outputs of the PID and the phase current balance control signals to determine the pulse width for each phase on each loop. The PWM generator has enough resolution to ensure that there are no limit cycles. The compensator coefficients are user configurable to enable optimized system response. The compensation algorithm uses a PID with two additional programmable poles. This provides the digital equivalent of a Type III analog compensator.

Dynamic load step-up and load step-down transients require fast system response to maintain the output voltage within specification limits. This is achieved by a unique adaptive non-linear digital transient control loop based on a proprietary algorithm.

## MULTIPLE TIME PROGRAMMING MEMORY

The multiple time programming memory (MTP) stores the device configuration. At power-up, MTP contents are transferred to operating registers for access during device operation. MTP allows customization during both design and high-volume manufacturing. MTP integrity is verified by Cyclic Redundancy Code (CRC) checking on each power up. The controller will not start up in the event of a CRC error.

The IR35204 offers up to 6 writes to configure basic device parameters such as frequency, fault operation characteristics, and boot voltage. This represents a significant size and component saving compared to traditional analog methods. The following pseudo-code illustrates how to write the MTP:

```
# write data
Set MTP Command Register = WRITE,
Line Pointer = An unused line
Poll MTP Command Register until Operation = IDLE.

# verify data was written correctly
Issue a READ Command; then poll OTP Operation Register
till Operation = IDLE
Verify that the Read Succeeded
```

## INTERNAL OSCILLATOR

The IR35204 has a single 96MHz internal oscillator that generates all the internal system clock frequencies required for proper device function. The oscillator frequency is factory trimmed for precision, and has extremely low jitter (Figure 4) even in light-load mode (Figure 5). A single internal oscillator is used to set the switching frequency on each loop independently.

## ADAPTIVE TRANSIENT ALGORITHM (ATA)

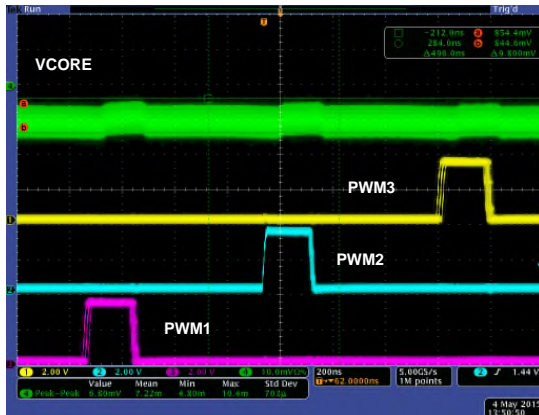

Figure 4: Persistence plot of a 3Φ, 50A system

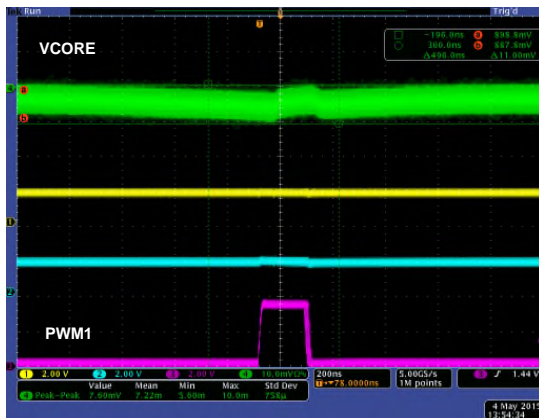

Figure 5: Persistence plot in 1Φ, 10A

## HIGH-PRECISION VOLTAGE REFERENCE

The internal high-precision voltage reference supplies the required reference voltages to the VID DACs, ADCs and other analog circuits. This factory trimmed reference is guaranteed over temperature and manufacturing variations.

## VOLTAGE SENSE

An error voltage is generated from the difference between the target voltage, defined by the VID and load line (if implemented), and the differential, remotely sensed, output voltage. For each loop, the error voltage is digitized by a high-speed, high-precision ADC. An anti-alias filter provides the necessary high frequency noise rejection. The gain and offset of the voltage sense circuitry for each loop is factory trimmed to deliver the required accuracy.

## CURRENT SENSE

Lossless inductor DCR or precision resistor current sensing is used to accurately measure individual phase currents. Using a simple off-chip thermistor, resistor and capacitor network for each loop, a thermally compensated load line is generated to meet the given power system requirement. A filtered voltage, which is a function of the total load current and the target load line resistance, is summed into each voltage sense path to accomplish the Active Voltage Positioning (AVP) function.

The IR35204 can also be used with R<sub>ds(on)</sub> current sensing PowIRstages. This algorithm helps reduce component by eliminating the need for the R-C sense components. Also, the thermistor used for thermal compensation would no longer be required, as this function is inherently designed into the R<sub>ds(on)</sub> sensing PowIRstages. The R-C network across the pins would still be required.

## VID DECODER

The VID decoder receives a VID code from the CPU that is converted to an internal code representing the VID voltage. This block also outputs the signal for VR disable if a VID shutdown code has been received. The 8 bit VID code supports Intel® VR12 & VR12.5 modes and VID settings are selectable as either 5mV/code or 10mV/code on each loop independently. When AMD SVI2 mode is chosen, both loops will be set to 6.25mV/code

## MOSFET DRIVER, POWER STAGE AND DRMOS COMPATIBILITY

The PWM output signals of the IR35204 are designed for compatibility with industry standard +3.3V Tri-State MOSFET drivers.

## I2C & PMBUS INTERFACE

An I2C or PMBus interface is used to communicate with the IR35204. This two-wire serial interface consists of clock and data signals, and operates as fast as 1MHz. The bus provides read and write access to the internal registers for configuration, and for monitoring of operating parameters. The bus is also used to program on-chip non-volatile memory (MTP) to store operating parameters.

To ensure operation with multiple devices on the bus, an exclusive address for the IR35204 is programmed

into MTP. The IR35204, additionally, supports pin-programming of the address.

To protect customer configuration and information, the I2C interface can be configured for either limited access with a 16-bit software password, or completely locked. Limited access includes both write and read protection options. In addition, there is a telemetry-only mode which only allows reads from the telemetry registers.

The IR35204 provides a hardware pin security option to provide extra protection. The protect pin is shared with the ADDR pin and is automatically engaged once the address is read. The pin must be driven high to disable protection. The pin can be enabled or disabled by a configuration setting in MTP.

The IR35204 supports the Packet Error Checking (PEC) protocol and a number of PMBus commands to monitor voltages and currents. For more information, refer to the PMBus Command Codes in Table 56.

## IR POWIRCENTER GUI

The IR PowIRCenter GUI provides the designer with a comprehensive design environment that includes interactive tools to calculate VR efficiency and DC error budget, design the thermal compensation and feedback loop networks, and produce calculated Bode plots and output impedance plots. The PowIRCenter GUI environment is a key utility for design optimization, debug, and validation of designs that saves the designer significant time, allowing faster time-to-market (TTM).

The PowIRCenter GUI allows real-time design optimization and monitoring of key parameters such as output current and power, input current and power, efficiency, phase currents, temperature, and faults.

The IR PowIRCenter GUI also allows access to the system configuration settings for switching frequency, MOSFET driver compatibility, soft start rate, VID table, PSI, loop compensation, transient control system parameters, input under-voltage, output over-voltage, output under-voltage, output over-current and over-temperature.

## PROGRAMMING

Once a design is complete, the PowIRCenter produces a complete configuration file.

The configuration file can be re-coded into an I2C/PMBus master (e.g. a Test System) and loaded into the IR35204 using the bus protocols described on page 48.

## REAL-TIME MONITORING

The IR35204 can be accessed through the use of PMBus Command codes (described in Table 56), to read the real time status of the VR system including input voltage, output voltage, input and output current, input and output power, efficiency, and temperature.

## THEORY OF OPERATION

### OPERATING MODE

The IR35204 changes its functionality based on the user-selected operating mode, allowing one device to be used for multiple applications without significant BoM changes. This greatly reduces the user's design cycles and Time-to-Market (TTM).

The functionality for each operating mode is completely configurable by simple selections in MTP. The mode configuration is shown in Table 1.

TABLE 1: MODE SELECTION

Mode	Description
VR12	Intel® VR12 (Selected via MTP).
VR12.5	Intel® VR12.5 (Selected via MTP).
IMVP8	Intel® IMVP8 (Selected via MTP).
SVI2	AMD SVI2 (Selected via MTP).
MPoL	Memory Mode, with Loop 2 output voltage = ½ Loop 1 output voltage.

### DEVICE POWER-ON AND INITIALIZATION

The IR35204 is powered from a 3.3V DC supply. Figure 6 shows the timing diagram during device initialization. An internal LDO generates a 1.8V rail to power the control logic within the device. During initial startup, the 1.8V rail follows the rising 3.3V supply voltage, proportional to an internal resistor tree. The internal oscillator becomes active at  $t_1$  as the 1.8V rail is ramping up. Until soft-start begins, the IR35204 PWM outputs are disabled in a high impedance state to ensure that the system comes up in a known state.

The controller comes out of power-on reset (POR) at  $t_2$  when the 3.3V supply is high enough for the internal bias control to generate 1.8V. The contents of the MTP are transferred to the registers by time  $t_3$  and the automatic trim routines are complete by time  $t_4$ . At this time, if enabled in MTP and when the VINSN voltage is valid, the controller will detect the populated phases by sensing the voltage on the PWM pins. If the voltage is less than the Auto Phase Detect threshold (unused PWMs are grounded), the controller assumes the phase is unpopulated. The register settings and number of phases define the controller performance

specific to the VR configuration, including trim settings, soft start ramp rate and boot voltage.

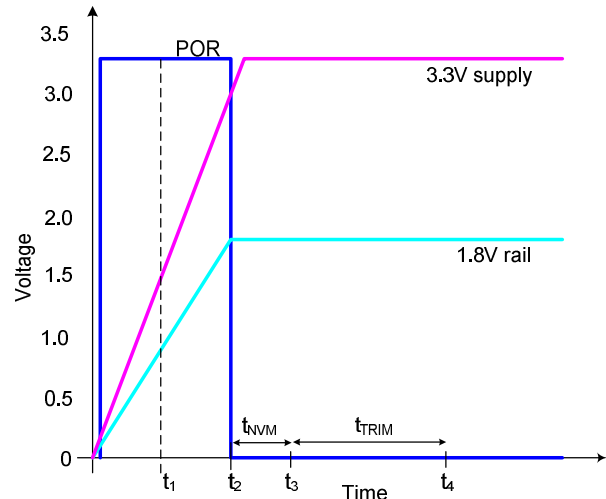

Figure 6: Controller Startup and Initialization

Once the registers are loaded from MTP, the designer can use I2C to re-configure the registers to suit the specific VR design requirements if desired.

### TEST MODE

Having the ADDR\_PROT pin high as the IC goes through 3.3V POR engages a special test mode in which the I2C address changes to 0Ah. This allows individual in-circuit programming of the controller. This is specifically useful in multi-controller systems that use a single I2C bus. *Note that MTP will not load to the working registers until the ADDR\_PROT pin goes low.*

### SUPPLY VOLTAGE

The controller is powered by the 3.3V supply rail. Once initialization of the device is complete, steady and stable supply voltage rails and a VR Enable signal (EN) are required to change the controller into an active state. The Enable signal is used to enable the PWM signals and begin the soft start sequence after the 3.3V and VIN supply rails are determined to be within the defined operating bands. The polarity of the chip enable function is bit-settable to either an active high or an active low configuration. When the controller is disabled by deactivating the Enable signal, it de-asserts VR READY and shuts down the regulator.

The recommended decoupling for the 3.3V is shown in Figure 7. The Vcc pin should have a 0.1µF and 1µF X5R-type ceramic capacitors placed as close as possible to the package.

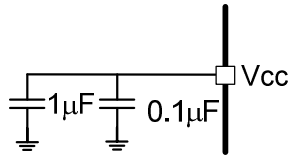

Figure 7: Vcc 3.3V decoupling

The CFILT pin must have a 1µF, X5R type decoupling capacitor connected close to the package as shown in Figure 8.

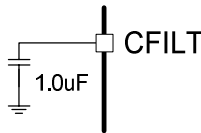

Figure 8: CFILT decoupling

The IR35204 is designed to accommodate a wide variety of input power supplies and applications and offers programmability of the VINSEN turn-on/off voltages.

TABLE 2: VINSEN TURN-ON/OFF VOLTAGE RANGE

Threshold	Range
Turn-on	4.5V to 13.1875V in 1/16V steps <sup>1</sup>
Turn-off	4.5V to 13.1875V in 1/16V steps <sup>1</sup>

<sup>1</sup> Must not be programmed below 4.5V

The supply voltage on the VINSEN pin is compared against a programmable threshold. Once the rising VINSEN voltage crosses the turn-on threshold and EN is asserted, all PWM outputs become active. The VINSEN supply voltage is valid until it declines below its programmed turn-off level.

A 14:1 attenuation network is connected to the VINSEN pin as shown in Figure 9. Recommended values for a 12V system are  $R_{VIN,1} = 13k\Omega$  and  $R_{VIN,2} = 1k\Omega$ , with a 1% tolerance or better.  $C_{VINSEN}$  is required to have a minimum 1nF for noise suppression, with a maximum value of 10nF.

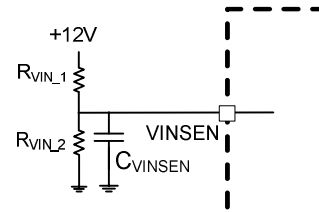

Figure 9: VINSEN resistor divider network

If enabled, VAUXSEN can be used to sense an auxiliary voltage like a 5V driver VCC, for example. The on and off thresholds are adjusted by selecting the correct divider network, R1 and R2.

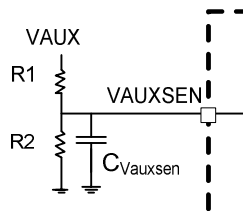

Figure 10: VAUXSEN resistor divider network

VAUX on and off thresholds are defined as:

$$VAUX_{on} = VAUXSEN_{on} * (1 + R1/R2)$$

$$VAUX_{off} = VAUXSEN_{off} * (1 + R1/R2)$$

With R2 set to 1KΩ, Table 3 shows the on and off thresholds for various values of R1.

TABLE 3: VAUXSEN TURN-ON/OFF VOLTAGES

R1	VAUX_on	VAUX_off
KΩ	Volt	Volt
5.77	4.50	3.97
8.78	6.50	5.74
11.80	8.50	7.50
14.81	10.50	9.27

Telemetry for VAUX is provided with 8 bit read only register, vaux\_supply. VAUX\_reported can be calculated with the following formula:

$$VAUX_{reported} = vaux\_supply(dec) * 4.883E-3 * (1 + R1/R2)$$

### POWER-ON SEQUENCING

The VR power-on sequence is initiated when all of the following conditions are satisfied:

- IR35204 Vcc (+3.3V rail) > VCC UVLO
- Input Voltage (VINSEN rail) > Vin UVLO



- Aux Voltage (VAUXSEN rail) > VAUXSEN UVLO (if configured)ENABLE is HIGH
- VR has no Over-current, Over-voltage, Over-temperature or Under-voltage faults
- MTP transfer to configuration registers occurred without parity error

Once the above conditions are cleared, start-up behavior is controlled by the operating mode.



Figure 11: Enable-based Startup

### POWER-OFF SEQUENCING

When +12Vdc goes below controller turn-off threshold, the controller tristates all PWM's. When enable goes low the controller ramps down Vout on both loops as shown in Figure 12.



Figure 12: Enable-based Shutdown

### INTEL MODE

When the power-on sequence is initiated, and with VBOOT set to > 0V, the output voltage will ramp to its configured boot voltage and assert VRDY. The slew rate to VBOOT is programmed per Table 21.

If Vboot = 0V, the VR will stay at 0V and will not soft-start until the CPU issues a VID command to the loop. In VR 13 mode, as soon as the IC is ready for SVID communication, VR\_READY will be asserted with Vboot = 0V.

### Intel Boot Voltage

The IR35204 Vboot voltage is fully vprogrammable in MTP to the range specified in the Intel VID tables. Table 14 and Table 15 show the Intel VID tables for for 5mV and 10mV VID steps respectively.

TABLE 8: VBOOT RANGE

Loop	Boot Voltage
Loop 1	Per Intel VR12 and VR12.5 VID table
Loop 2	Per Intel VR12 and VR12.5 VID table

### Intel SVID Interface

The IR35204 implements a fully compliant Intel® VR12 & VR12.5 Serial VID (SVID) interface. This is a three-wire interface between an Intel® VR12 ,VR12.5 & IMVP8 compliant processor and a VR that consists of clock, data and alert# signals.

The IR35204 architecture is based upon a digital core and hence lends itself very well to digital communications. As such, the IR35204 implements all the required SVID registers and commands. The IR35204 also implements many of the optional commands and registers with very few exceptions. The Intel CPU is able to detect and recognize the extra functionality that the IR35204 provides and thus gives the Intel® VR 13/12/12.5/IMVP8 CPU unparalleled ability to monitor and optimize its power.

The SVID address of the IR35204 defaults to 0. This address may be re-programmed in MTP. An address lock function prevents accidental overwrites of the address.

The pseudo-code below illustrates the MTP address programming:

```
# unlock the address register to write, then lock
Set Address_lock_bit=0
Write new SVID address
Set Address_lock_bit=1
```

### Intel VID Offset

The output voltage can be offset instead of setting a manual VID value, according to Table 9. This is especially useful for memory applications where voltages higher than the standard VID table may be required.

**TABLE 9: VID OFFSET**

Parameter	Memory	Range	Step Size
Output Voltage	R/W	-128 to +127	1 VID code

Maximum allowed voltage is 3.04V (VR12.5)

Note that the Vmax register must be set appropriately to allow the required output voltage offset.

### Intel Reporting Offsets

In addition to the mandatory features of the SVID bus, the IR35204 provides optional volatile SVID registers which allow the user to offset the reporting on the SVID interface as detailed in Table 10.

**TABLE 10: SVID OFFSET REGISTERS**

Parameter	Memory	Range	Step size
Output Current	NVM	-4A to +3.75A	0.25A
Temperature	R/W	-32°C to +31°C	1°C

### All Call SUPPORT

All Call for each loop of IR35204 can be configured in following ways:

- 0E and 0F.
- 0E only.
- 0F only.
- No All Call

IR35204 can be configured to be used as VR for CPU which is All Call 0F or Memory which is All Call 0E.

### VR12.5 Operation

VR12.5 mode is selectable via MTP bit. The boot voltage in VR12.5 is also selectable and can be taken from the boot registers.

### IMVP8 Operation

IMVP8 mode is selectable via MTP bit. The boot voltage in IMVP8 mode is configured in the boot register in 5mV steps compatible to VR12 mode VID table i.e. Table 14 or in 10mV steps compatible to VR12.5 mode VID table i.e. Table 15. In IMVP8 mode, bit 3 of SVID register “Status 1” (10h) is defined as “VID DAC high”. This bit when set is an indicator to the CPU that the VR VID DAC is greater than 30mV above a new VID recently set by an SetVID command.

In IMVP8 mode, IR35204 does support PS4 command, however, it does not shut down the circuitry to reduce quiescent power consumption to <1mW. Thus, IR35204 is meant to be operated in IMVP8 mode for overclocking applications only where it is not expected for VR to shut down its circuitry to reduce quiescent power consumption.

### Loop Start-Up Sequence and Delay

IR35204 can be configured to enable both loops in one of the following possible sequences:

- Both loops start together.
- Loop 2 follows Loop 1.
- Loop1 follows Loop 2.

If IR35204 is configured such that one loop follows the other, the delay between the two loops can be adjusted for following pre-defined intervals:

- 0 mS, 0.25 mS, 0.5 mS, 1 mS, 2.5 mS, 5 mS, 10 mS.

### Memory (MPoL) Mode

In MPoL mode the IR35204 configures Loop 2 VID to 50% of Loop 1. Communication with and control of the IR35204 may occur either through the SVID interface when an Intel SVID Master is present, or alternatively through the I2C/SMBus/PMBus interface for non-Intel applications.

The IR35204 follows startup and timing requirements as shown in Figure 13. When the power-on sequence is initiated, and with VBOOT set to > 0V, both rails will ramp to their configured voltages and assert VR\_READY\_L1 and VR\_READY\_L2. The slew rates for both loops are set independently per Table 21. If tracking is required during the slew, then care must be taken to ensure that the Loop 2 slew rate is set to ½ of the Loop 1 slew rate. Typical MPoL start-up and shut-down waveforms are shown in Figure 14 and Figure 15.

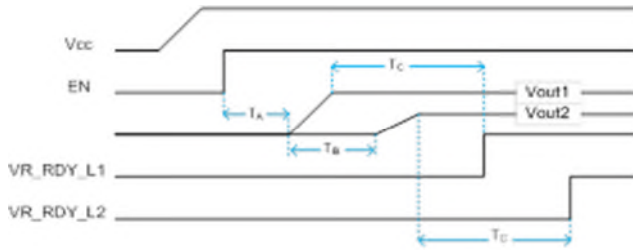

Figure 13: MPoL Startup

TABLE 13: MPoL LOOP 2 START-UP DELAY

Loop 2 Delay
0 – 678.3usec in 2.66usec Steps

TABLE 12: MPoL START-UP TIMING

Time	Description	Min	Typ	Max
T <sub>A</sub>	VR_EN to Loop 1 start		3μs	
T <sub>B</sub>	Loop 2 delay		Table	
T <sub>C</sub>	Voltage ramp complete to VR_RDY_L1/L2			1μs

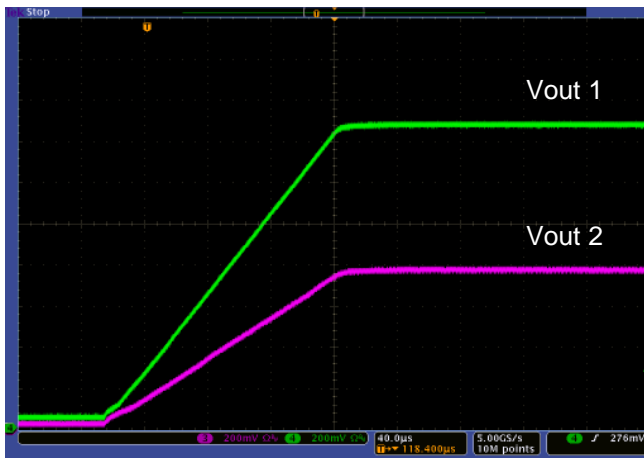

Figure 14: MPoL Tracking Startup



Figure 15: MPoL Tracking Shutdown

In MPoL mode, Loop 2 start-up can be delayed relative to Loop 1 according to 2.

Table 14: Intel VR12 VID Table – 5mV VID Step

VID (Hex)	Voltage (V)	VID (Hex)	Voltage (V)	VID (Hex)	Voltage (V)	VID (Hex)	Voltage (V)	VID (Hex)	Voltage (V)
FF	1.52	DA	1.335	B5	1.15	90	0.965	6B	0.78
FE	1.515	D9	1.33	B4	1.145	8F	0.96	6A	0.775
FD	1.51	D8	1.325	B3	1.14	8E	0.955	69	0.77
FC	1.505	D7	1.32	B2	1.135	8D	0.95	68	0.765
FB	1.5	D6	1.315	B1	1.13	8C	0.945	67	0.76
FA	1.495	D5	1.31	B0	1.125	8B	0.94	66	0.755
F9	1.49	D4	1.305	AF	1.12	8A	0.935	65	0.75
F8	1.485	D3	1.3	AE	1.115	89	0.93	64	0.745
F7	1.48	D2	1.295	AD	1.11	88	0.925	63	0.74
F6	1.475	D1	1.29	AC	1.105	87	0.92	62	0.735
F5	1.47	D0	1.285	AB	1.1	86	0.915	61	0.73
F4	1.465	CF	1.28	AA	1.095	85	0.91	60	0.725
F3	1.46	CE	1.275	A9	1.09	84	0.905	5F	0.72
F2	1.455	CD	1.27	A8	1.085	83	0.9	5E	0.715
F1	1.45	CC	1.265	A7	1.08	82	0.895	5D	0.71
F0	1.445	CB	1.26	A6	1.075	81	0.89	5C	0.705
EF	1.44	CA	1.255	A5	1.07	80	0.885	5B	0.7
EE	1.435	C9	1.25	A4	1.065	7F	0.88	5A	0.695
ED	1.43	C8	1.245	A3	1.06	7E	0.875	59	0.69
EC	1.425	C7	1.24	A2	1.055	7D	0.87	58	0.685
EB	1.42	C6	1.235	A1	1.05	7C	0.865	57	0.68
EA	1.415	C5	1.23	A0	1.045	7B	0.86	56	0.675
E9	1.41	C4	1.225	9F	1.04	7A	0.855	55	0.67
E8	1.405	C3	1.22	9E	1.035	79	0.85	54	0.665
E7	1.4	C2	1.215	9D	1.03	78	0.845	53	0.66
E6	1.395	C1	1.21	9C	1.025	77	0.84	52	0.655
E5	1.39	C0	1.205	9B	1.02	76	0.835	51	0.65
E4	1.385	BF	1.2	9A	1.015	75	0.83	50	0.645
E3	1.38	BE	1.195	99	1.01	74	0.825	4F	0.64
E2	1.375	BD	1.19	98	1.005	73	0.82	4E	0.635
E1	1.37	BC	1.185	97	1	72	0.815	4D	0.63
E0	1.365	BB	1.18	96	0.995	71	0.81	4C	0.625
DF	1.36	BA	1.175	95	0.99	70	0.805	4B	0.62
DE	1.355	B9	1.17	94	0.985	6F	0.8	4A	0.615
DD	1.35	B8	1.165	93	0.98	6E	0.795	49	0.61
DC	1.345	B7	1.16	92	0.975	6D	0.79	48	0.605
DB	1.34	B6	1.155	91	0.97	6C	0.785	47	0.6

VID (Hex)	Voltage (V)	VID (Hex)	Voltage (V)	VID (Hex)	Voltage (V)	VID (Hex)	Voltage (V)	VID (Hex)	Voltage (V)
46	0.595	37	0.52	28	0.445	19	0.37	0A	0.295
45	0.59	36	0.515	27	0.44	18	0.365	09	0.29
44	0.585	35	0.51	26	0.435	17	0.36	08	0.285
43	0.58	34	0.505	25	0.43	16	0.355	07	0.28
42	0.575	33	0.5	24	0.425	15	0.35	06	0.275
41	0.57	32	0.495	23	0.42	14	0.345	05	0.27
40	0.565	31	0.49	22	0.415	13	0.34	04	0.265
3F	0.56	30	0.485	21	0.41	12	0.335	03	0.26
3E	0.555	2F	0.48	20	0.405	11	0.33	02	0.255
3D	0.55	2E	0.475	1F	0.4	10	0.325	01	0.25
3C	0.545	2D	0.47	1E	0.395	0F	0.32	00	0
3B	0.54	2C	0.465	1D	0.39	0E	0.315		
3A	0.535	2B	0.46	1C	0.385	0D	0.31		
39	0.53	2A	0.455	1B	0.38	0C	0.305		
38	0.525	29	0.45	1A	0.375	0B	0.3		

Table 15: Intel VR12.5 VID Table – 10mV VID Step

VID (HEX)	VOLTAGE (V)	VID (HEX)	VOLTAGE (V)	VID (HEX)	VOLTAGE (V)	VID (HEX)	VOLTAGE (V)	VID (HEX)	VOLTAGE (V)
FF	3.04	E1	2.74	C3	2.44	A5	2.14	87	1.84
FE	3.03	E0	2.73	C2	2.43	A4	2.13	86	1.83
FD	3.02	DF	2.72	C1	2.42	A3	2.12	85	1.82
FC	3.01	DE	2.71	C0	2.41	A2	2.11	84	1.81
FB	3.00	DD	2.70	BF	2.40	A1	2.10	83	1.80
FA	2.99	DC	2.69	BE	2.39	A0	2.09	82	1.79
F9	2.98	DB	2.68	BD	2.38	9F	2.08	81	1.78
F8	2.97	DA	2.67	BC	2.37	9E	2.07	80	1.77
F7	2.96	D9	2.66	BB	2.36	9D	2.06	7F	1.76
F6	2.95	D8	2.65	BA	2.35	9C	2.05	7E	1.75
F5	2.94	D7	2.64	B9	2.34	9B	2.04	7D	1.74
F4	2.93	D6	2.63	B8	2.33	9A	2.03	7C	1.73
F3	2.92	D5	2.62	B7	2.32	99	2.02	7B	1.72
F2	2.91	D4	2.61	B6	2.31	98	2.01	7A	1.71
F1	2.90	D3	2.60	B5	2.30	97	2.00	79	1.70
F0	2.89	D2	2.59	B4	2.29	96	1.99	78	1.69
EF	2.88	D1	2.58	B3	2.28	95	1.98	77	1.68
EE	2.87	D0	2.57	B2	2.27	94	1.97	76	1.67
ED	2.86	CF	2.56	B1	2.26	93	1.96	75	1.66
EC	2.85	CE	2.55	B0	2.25	92	1.95	74	1.65
EB	2.84	CD	2.54	AF	2.24	91	1.94	73	1.64
EA	2.83	CC	2.53	AE	2.23	90	1.93	72	1.63
E9	2.82	CB	2.52	AD	2.22	8F	1.92	71	1.62
E8	2.81	CA	2.51	AC	2.21	8E	1.91	70	1.61
E7	2.80	C9	2.50	AB	2.20	8D	1.90	6F	1.60
E6	2.79	C8	2.49	AA	2.19	8C	1.89	6E	1.59
E5	2.78	C7	2.48	A9	2.18	8B	1.88	6D	1.58
E4	2.77	C6	2.47	A8	2.17	8A	1.87	6C	1.57
E3	2.76	C5	2.46	A7	2.16	89	1.86	6B	1.56
E2	2.75	C4	2.45	A6	2.15	88	1.85	6A	1.55

VID (HEX)	VOLTAGE (V)	VID (HEX)	VOLTAGE (V)	VID (HEX)	VOLTAGE (V)	VID (HEX)	VOLTAGE (V)	VID (HEX)	VOLTAGE (V)
69	1.54	53	1.32	3D	1.10	27	0.88	11	0.66
68	1.53	52	1.31	3C	1.09	26	0.87	10	0.65
67	1.52	51	1.30	3B	1.08	25	0.86	F	0.64
66	1.51	50	1.29	3A	1.07	24	0.85	E	0.63
65	1.50	4F	1.28	39	1.06	23	0.84	D	0.62
64	1.49	4E	1.27	38	1.05	22	0.83	C	0.61
63	1.48	4D	1.26	37	1.04	21	0.82	B	0.60
62	1.47	4C	1.25	36	1.03	20	0.81	A	0.59
61	1.46	4B	1.24	35	1.02	1F	0.80	9	0.58
60	1.45	4A	1.23	34	1.01	1E	0.79	8	0.57
5F	1.44	49	1.22	33	1.00	1D	0.78	7	0.56
5E	1.43	48	1.21	32	0.99	1C	0.77	6	0.55
5D	1.42	47	1.20	31	0.98	1B	0.76	5	0.54
5C	1.41	46	1.19	30	0.97	1A	0.75	4	0.53
5B	1.40	45	1.18	2F	0.96	19	0.74	3	0.52
5A	1.39	44	1.17	2E	0.95	18	0.73	2	0.51
59	1.38	43	1.16	2D	0.94	17	0.72	1	0.50
58	1.37	42	1.15	2C	0.93	16	0.71	0	0.00
57	1.36	41	1.14	2B	0.92	15	0.70		
56	1.35	40	1.13	2A	0.91	14	0.69		
55	1.34	3F	1.12	29	0.90	13	0.68		
54	1.33	3E	1.11	28	0.89	12	0.67		

**PHASING**

The number of phases enabled on each loop of the IR35204 is shown in Table 16. The phase of the PWM outputs is automatically adjusted to optimize phase interleaving for minimum output ripple. Phase interleaving results in a ripple frequency that is the product of the switching frequency and the number of phases. A high ripple frequency results in reduced ripple voltage, thereby minimizing the output filter capacitance requirements, resulting in significant total BOM cost reduction.

**TABLE 16: LOOP CONFIGURATION**

Configuration	Loop 1	Loop 2
3+0	3-phases	-
2+0	2-phases	-
1+0	1-phase	-
3+1	3-phases	1-phase
2+1	2-phases	1-phase
1+1	1-phase	1-phase

**UNUSED PHASES**

Phases are disabled based upon the configuration shown in Table 16. Disabled PWM outputs should be left floating unless the auto-populate phase detection feature is used. Unused phases should be disconnected in reverse order to ensure a correct phase relationship. E.g. a 3+0 configuration must have PWMs on phase 3 disconnected in order to operate in 2+0 mode. If phases 1 or 2 were disconnected instead, the remaining phases would not have a symmetrical relationship, leading to unreliable performance. If the auto-populate phase detection feature is used, unused PWM outputs should be grounded so that their voltage is below the threshold (phase is disabled). IR35204 automatically adjusts the phase configuration to operate with the populated phases (up to the configuration allowed by the settings in Table 16).

In addition, the IR35204 detects the number of populated phases at start-up by comparing the voltage on the PWM pin against the phase detection threshold. In order for populated phases to be detected, the MOSFET drivers need to be powered up before the VCC, +12Vin and Vaux to the IR35204 exceeds its POR threshold.

Typical PWM pulse phase relationships are shown in Table 17 and

Figure 16.

**TABLE 17: PHASE RELATIONSHIP**

Phases	Phasing
1	-
2	180°
3	120°

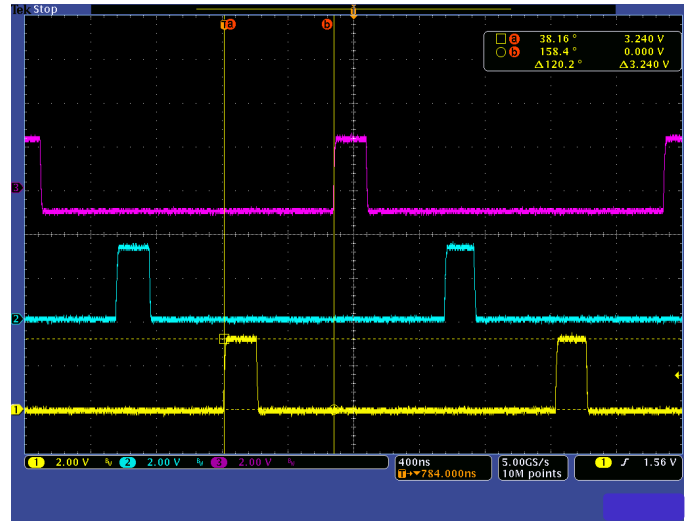

**Figure 16: 3-phase PWM interleaved operation**

**SWITCHING FREQUENCY**

The phase switching frequency (Fsw) of the IR35204 is set by a user configurable register. The switching frequency can be set independently on each loop. The switching frequency variation with register setting has been plotted in Figure 17.

The IR35204 oscillator is factory trimmed to guarantee high accuracy and very low jitter compared to analog controllers.



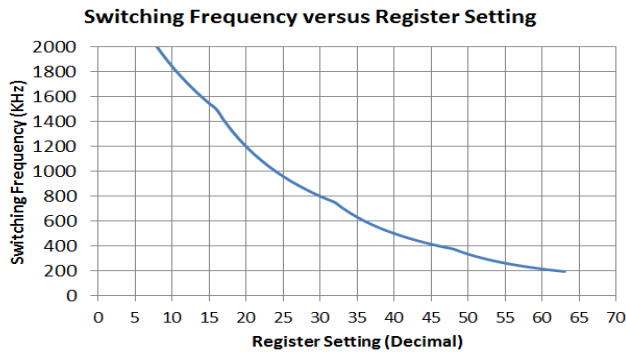

Figure 17: Switching Frequency Variation with Register Setting

### MOSFET DRIVER AND POWERSTAGE SELECTION

The PWM signals from the active phases of the IR35204 are designed to operate with industry standard tri-state type drivers or PowIRstage devices. The logic operation for these types of tri-state drivers is depicted in Figure 18.

When in tri-state, the IR35204 floats the outputs so that the voltage level is determined by an external voltage divider which is typically inside the MOSFET driver. Sometimes external resistors are added to improve the speed of the PWM signal going into tri-state.

Note that the PWM outputs are tri-stated whenever the controller is disabled (EN = low), the shut-down ramp has completed or before the soft-start ramp is initiated.

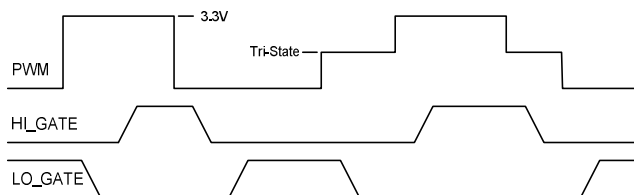

Figure 18: 3.3V Tri-state Driver Logic Levels

### OUTPUT VOLTAGE DIFFERENTIAL SENSING

The IR35204 VSEN and VRTN pins for each loop are connected to the load sense pins of the output voltage to provide true differential remote voltage sensing with high common-mode rejection. Each loop has a high bandwidth error amplifier that generates the error voltage between this remote sense voltage and the

target voltage. The error voltage is digitized by a fast, high-precision ADC.

As shown in Figure 19, the Vsen and Vrtn inputs have a 20kΩ pull-up to an internal 1V rail. This causes some current flow in the Vsen and Vrtn lines. To minimize the offset created by this current flow, the external series impedance on these lines needs to be kept to a minimum.

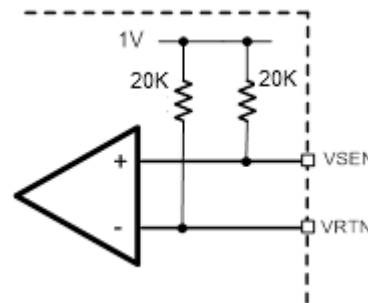

Figure 19: Output Voltage sensing impedance

### INPUT CURRENT SENSING

The IR35204 provides input current sensing to measure the power drawn by the load from the source. A precision current sense resistor is connected in series with the input path as shown in Figure 21. The voltage across the current sense resistor is differentially amplified by a current sense amplifier and fed to I\_IN pin of IR35204. An internal ADC converts the sensed voltage into its digital equivalent. The I\_IN pin input voltage range is 0 to 1.25Vdc.

$$I\_IN(V) = I_{in} * R_{SENSE} * CSA_{GAIN}$$

The IR35204 offers four full-scale ranges for input current.

1. 0 – 62.5A.
2. 0 – 31.25A.
3. 0 – 15.625A.
4. 0 – 7.8125A.

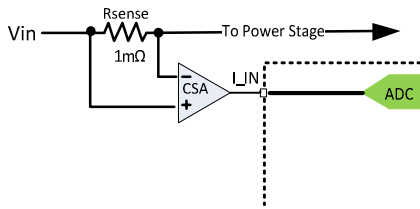

Figure 20 Input Current Sensing

### PIN\_ALERT

The IR35204 has a PIN\_ALERT# pin to alert the system when the input power has exceeded a preset threshold. The pin is an open drain output that is high until the input power threshold is exceeded at which point it pulls low. The output stays low until the input power drops below 90% of the Pin\_Alert threshold. The PIN\_ALERT# pin will de-assert 100mS after the input power drops below 90% of the PIN\_ALERT threshold. In an Intel system the Pin\_alert pin is pulled up with a 4.99kΩ resistor to 3.3 Vdc. The PIN is filtered by a 2KHz BW filter. The PIN\_ALERT# pin assertion will be delayed by up to 300uS.

### OUTPUT CURRENT SENSING

The IR35204 provides per-phase output current sensing to support accurate Adaptive Voltage Positioning (AVP), current balancing, and over-current protection. The differential current sense scheme supports both lossless inductor DCR and  $R_{DS(ON)}$  (or per-phase series precision resistor) current sensing techniques.

For DCR sensing, a suitable resistor-capacitor network of  $R_{sen}$  and  $C_{sen}$  is connected across the inductor in each phase as shown in Figure 21 below. The time constant of this RC network is set to equal the inductor time constant ( $L/DCR$ ) such that the voltage across the capacitor  $C_{sen}$  is equal to the voltage across the inductor DCR.

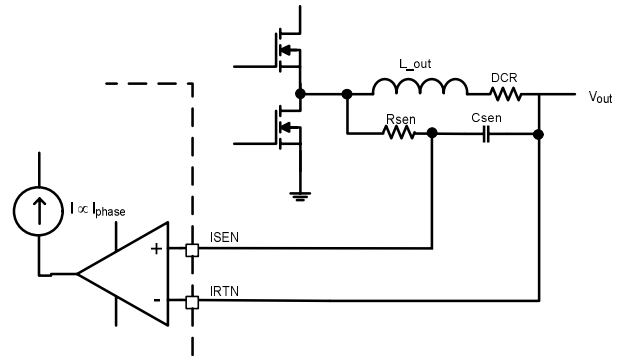

Figure 21: DCR Current Sensing

A current proportional to the inductor current in each phase is generated and used for per-phase current balancing. The individual phase current signals are summed to arrive at the total current.

The phase currents and total current are quantized by the monitoring ADC and used to implement the current monitoring and OCP features. The total current is also summed with the VID DAC output to implement the AVP function.

The recommended value for  $C_{sen}$  is 220nF, with an NPO type dielectric. To prevent undershooting of the output voltage during load transients, the  $R_{sen}$  resistor can be calculated by:

$$R_{sen} = \frac{1.05 * L_{out}}{C_{sen} * DCR}$$

**Note: Use thick film resistor (0603) for  $R_{sen}$ .**

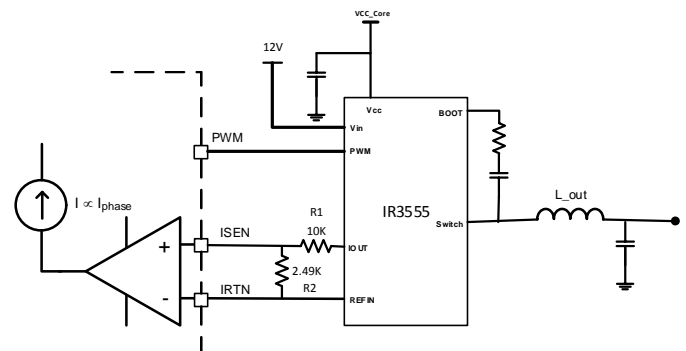

Figure 22  $R_{DS(ON)}$  Current Sense

Additionally, the current sense inputs to the IR35204 can also be directly fed the current information from a PowIRstage having  $R_{DS(ON)}$  sensing capability, thereby

eliminating the need for the R-C sense components,  $R_{SEN}$  and  $C_{SEN}$  as shown in Figure 22. The IR3555 has an IOU<sub>T</sub> gain of 5mV/A. A divider of 5:1 should be used to match the ISENSE amp input dynamic range. The recommended values are 10K and 2.49K. The REFIN pin is offset above 0V by connecting it to the 1.8V CFILT pin.

### CURRENT BALANCING & OFFSET

The IR35204 provides accurate digital phase current balancing in any phase configuration. Current balancing equalizes the current across all the phases. This improves efficiency, prevents hotspots and reduces the possibility of inductor saturation.

The sensed currents for each phase are converted to a voltage and are multiplexed into the monitoring ADC. The digitized currents are low-pass filtered and passed through a proprietary current balance algorithm to enable the equalization of the phase currents as shown in Figure 23.

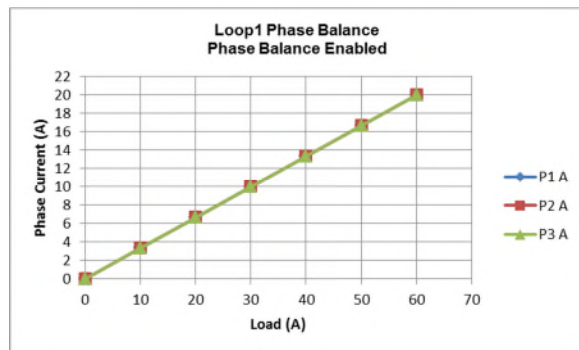

Figure 23: Typical Phase Current Balance (3-phases enabled)

The proprietary high-speed active phase current balance operates during load transients to eliminate current imbalance that can result from a load current oscillating near the switching frequency. The order in which the phases output PWM pulses is decided based on an adaptive High Speed Phase Balance (HSPB) to ensure that the phases remain balanced during high frequency load transients. Once the VR returns to steady-state operation, the phases return to the normal phase firing order.

In addition, the IR35204 allows the user to offset phase currents to optimize the thermal solution. Figure 24 shows Phase 1 current gain offset to a value of 6. This scales the current in phase 1 to have

approximately 30% more current than the other phases.

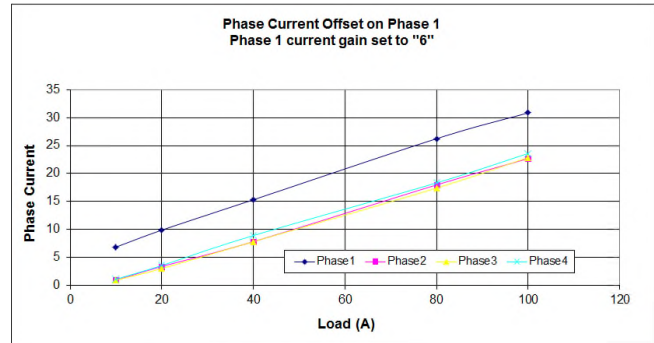

Figure 24: Phase 1 Current Offset

### CURRENT CALIBRATION

For optimizing the current measurement accuracy of a design, the IR35204 contains a register in MTP, which can store a user-programmed per phase Current Offset, to zero out the no-load current reading. Refer to Table 43 for output current calibration registers.

### LOAD LINE

The IR35204 enables the implementation of an accurate, temperature compensated load line.

The nominal load line is set by an external resistor  $R_{CS}$ , as shown in Figure 25. This load line value also needs to be stored in MTP. The stored values for load line, scaling and gain provide the scaling factors required for digital computation of the total current, in order to determine the true current, OCP threshold, and output voltage telemetry registers.

For each loop, the sensed current from all the active phases is summed and applied differentially to a resistor network across the RSCP and RSCM pins as shown in Figure 25. This generates a precise proportional voltage, which is summed with the sensed output voltage and VID DAC reference to form the error voltage.

IR35204 supports two types of current sense techniques.

1. DCR Current Sense.
2.  $R_{DS(ON)}$  Current Sense.

**DCR Current Sense**

DCR current sense technique measures the voltage drop across DCR of the inductor as shown in Figure 21. DCR of the inductor has a positive temperature coefficient of resistance. Hence, to compensate for increase in DCR with respect to temperature and thermistor  $R_{Th}$  having negative temperature coefficient of resistance is also part of the network. For proper load line temperature compensation, the thermistor is placed near the phase one inductor to accurately sense the inductor temperature.

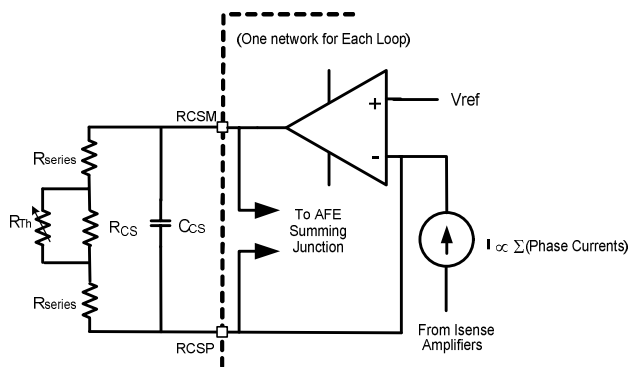

**Figure 25: Load Line & Thermal Compensation for DCR Sense**

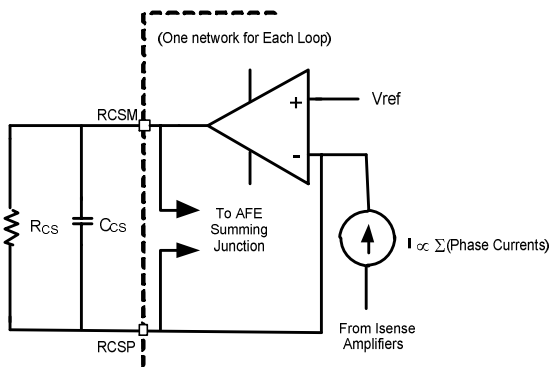

**Figure 26 Load Line for  $R_{DS(ON)}$  Current Sense**

The resistor  $R_{CS}$  is calculated using the following procedure:

1. Calculate the  $R_{CS\text{effective}}$  or the total effective parallel resistance across the RSCP and R\_CSM pins as defined by:

$$R_{CS\text{effective}} = 8 \times R_{ISEN} \times \frac{R_{LL}}{DCR}$$

where  $R_{LL}$  is the desired load line, DCR is DC resistance of the phase inductor, and  $R_{ISEN}$  is the internal series resistor = 1000Ω.

2. Select a suitable NTC thermistor,  $R_{Th}$ . This is typically selected to have the lowest thermal coefficient and tightest tolerance in a standard available package. A typical NTC used in these applications is a 10kΩ, 1% tolerance device. Recommended thermistors are shown in Table 18.

**TABLE 18: 10K 1% NTC THERMISTORS**

<b>Murata</b>	NCP18XH103F03RB
<b>Panasonic</b>	ERTJ1VG103FA
<b>TDK</b>	NTCG163JF103F

3. Calculate  $R_{CS}$  using the following equation:

$$R_{CS} = \frac{1}{\frac{1}{R_{CS\text{effective}}} - \frac{1}{2 \times R_{series}} - \frac{1}{R_{Th}}}$$

$R_{series}$  is selected to achieve minimum load line error over temperature. The IR PowIRCenter GUI provides a graphical tool that allows the user to easily calculate the resistor values for minimum error.

The capacitor  $C_{CS}$  is defined by the following equation:

$$C_{CS} = \frac{1}{2 \times \pi \times R_{CS\text{effective}} \times f_{AVP}}$$

where  $f_{AVP}$  is the user selectable current sense AVP bandwidth. The recommended bandwidth is typically in the range of 200kHz to 300kHz.

**$R_{DS(ON)}$  Current Sense**

IR35204 reads the current value from individual power stages as shown in Figure 22. The power stage measures the output current by sensing the voltage drop across lower side MOSFET. The current sensed by the power stage is thermally compensated hence there is no need of an external thermistor for temperature compensation. Thus,  $R_{DS(ON)}$  current sense reduces the component count required for loadline measurement as shown in Figure 26.

The resistor  $R_{CS}$  for  $R_{DS\ ON}$  current sense is calculated by using the following procedure.

$$R_{CS} = 8 * R_{ISEN} * R_{LL} / (I_{R_{DS\ ON\ Scale}} * Divider\ Ratio)$$

Where  $I_{R_{DS\ ON\ Scale}}$  = current scale of Power Stage in V/A

$$Divider\ Ratio = \frac{R_2}{R_1 + R_2} \text{ .Refer to Figure 22}$$

The capacitor  $C_{CS}$  is defined by the following equation:

$$C_{CS} = \frac{1}{2 * \pi * R_{CS} * f_{AVP}}$$

where  $f_{AVP}$  is the user selectable current sense AVP bandwidth. The recommended bandwidth is typically in the range of 200kHz to 300kHz.

### Setting a 0mΩ Load Line

The load line is turned off by setting the Loadline Enable bit low. This is a separate bit from the load line settings for each loop.

Even though the load line is disabled digitally, the load-line resistors and scaling registers should be set such that the load line is at least 3 times the value of low ohmic DCR inductors (<0.5mΩ) or equal to the DCR value for high ohmic inductors (>0.5mΩ). For example, if the inductor(s) DCR is 0.3mΩ, a nominal 0.9 mΩ load line should be set. For accurate current measurement and OCP threshold with the load line disabled, the output current gain and scaling registers must be set to the same value as the load line set with the external resistor network. With load line disabled, the thermistor and  $C_{CS}$  capacitor must still be installed to insure accuracy of the current measurement.

Figure 27 shows a typical 1.05mΩ load line measurement with minimum and maximum error ranges. The controller accuracy lies well within common processor requirements.

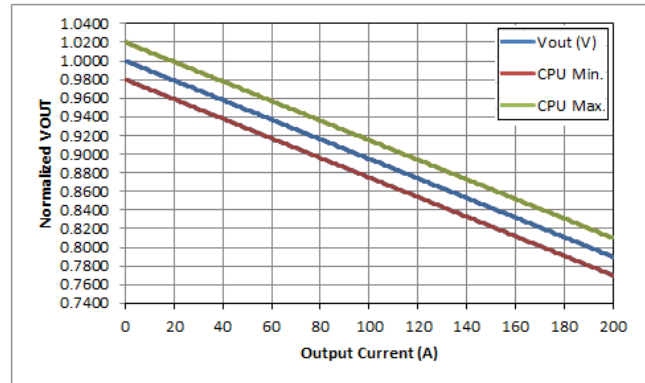

Figure 27: Load Line Measurements

The load line range for IR35204 is shown in Table 19.

TABLE 19: LOAD LINE SETTINGS

	Loop #1	Loop #2
Minimum	0.0 mΩ	0.0 mΩ
Maximum	6.375 mΩ	12.75 mΩ
Resolution	0.025 mΩ	0.050 mΩ

### DIGITAL FEEDBACK LOOP & PWM

The IR35204 uses a digital feedback loop to minimize the requirement for output decoupling, and to maintain a tightly regulated output voltage. The error between the target and the output voltage is digitized and passed through a low pass filter. This filtered signal is then passed through an initial single-pole filter stage, followed by the PID (Proportional Integral Derivative) compensator, and an additional single-pole filter stage. The loop compensation parameters  $K_p$  (proportional coefficient),  $K_i$  (integral coefficient), and  $K_d$  (derivative coefficient), as well as the low-pass filter pole locations are user-configurable to optimize the VR design for the chosen external components.

The adaptive PID control used in IR35204 intelligently scales the coefficients and the low-pass filters in real-time, to maintain optimum stability, as phases are added and dropped dynamically in the application. This auto-scaling feature significantly reduces design time by virtue of having to design the PID coefficients design only for one loop combination. (Figure 28).

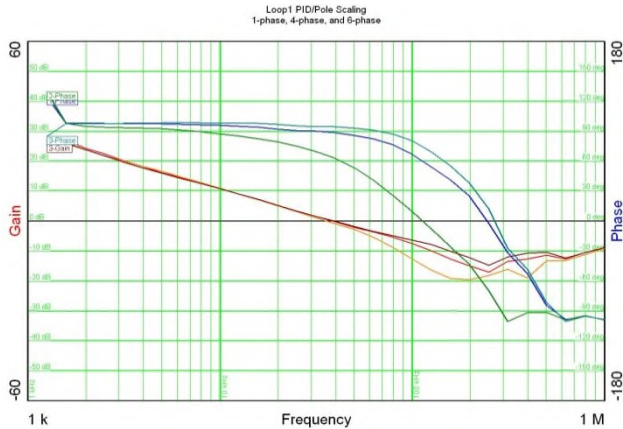

Figure 28: Stability with Phase Add/Drop

Each of the proportional, integral and derivative terms is a 6-bit value stored in MTP that is decoded by the IC's digital core. This allows the designer to set the converter bandwidth and phase margin to the desired values.

The compensator transfer function is defined as:

$$\left( K_p + \frac{K_i}{s} + K_d \cdot s \right) \cdot \left( \frac{1}{1 + s/\omega_{p1}} \right) \cdot \left( \frac{1}{1 + s/\omega_{p2}} \right)$$

where  $\omega_{p1}$  and  $\omega_{p2}$  are the two configurable poles, typically positioned to filter noise, and to roll off the high-frequency gain that the  $K_d$  term creates.

The outputs of the compensator and the phase current balance block are fed into a digital PWM pulse generator to generate the PWM pulses for the active phases. The digital PWM generator has a native time resolution of 1.3ns which is combined with digital dithering to provide an effective PWM resolution of 163ps. This ensures that there is no limit cycling when operating at the highest switching frequency.

### ADAPTIVE TRANSIENT ALGORITHM (ATA)

The IR35204 Adaptive Transient Algorithm (ATA) is a high speed non-linear control technique that allows compliance with CPU voltage transient load regulation requirements, with minimum output bulk capacitance for reduced system cost.

A high-speed digitizer measures both the magnitude and slope of the error signal to predict the load current transient. This prediction is used to control the pulse

widths and the phase relationships of the PWM pulses. The ATA bypasses the PID control momentarily during load transients to achieve very wideband closed loop control and smoothly transitions back to PID control during steady state load conditions. Figure 29 illustrates the transient performance improvement provided by the ATA showing the clear reduction in undershoot and overshoot. Figure 30 is a zoomed-in scope capture of a load step, illustrating the fast reaction time of the ATA, and how the algorithm changes the pulse phase relationships. IR35204 provides the option to enable or disable this feature, using a digitally programmable bit.

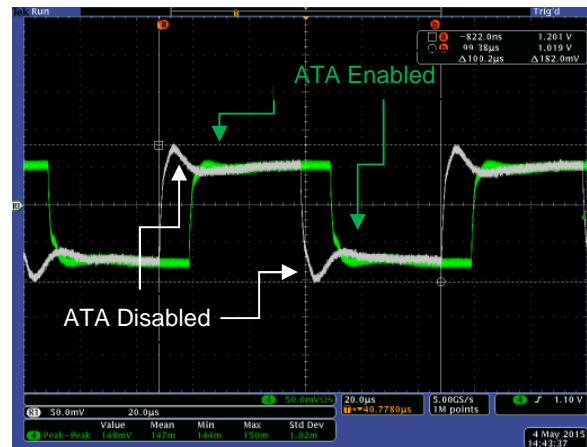

Figure 29: ATA Enable/Disable Comparison

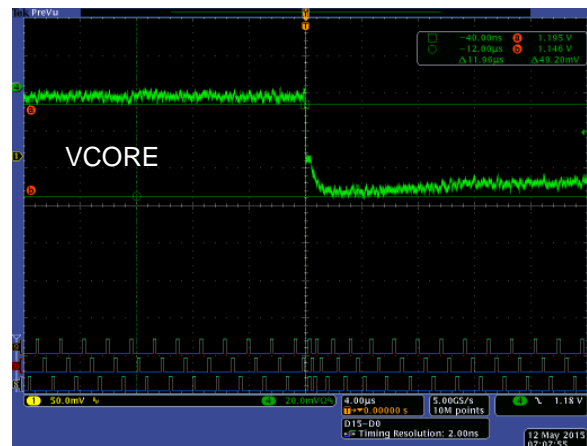

Figure 30: ATA feature – zoomed-in

In addition, during a load transient overshoot, the ATA may also be programmed to turn off the low-side MOSFETS instead of leaving them on. This forces the load current to flow through the larger FET body diode, and helps to reduce the overshoot created during a load release, as showing in Figure 31 below.

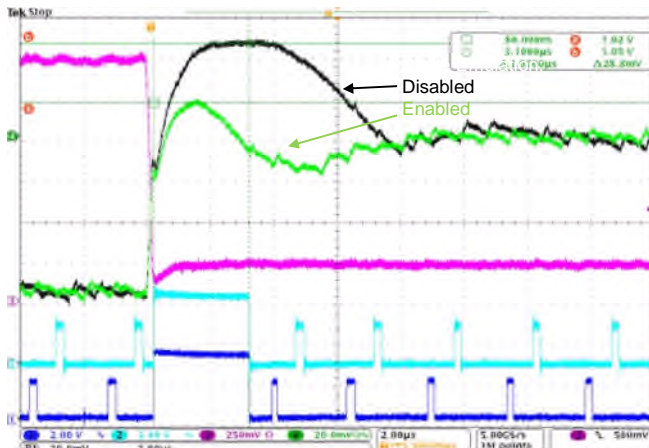

Figure 31: Diode Emulation during a load release

### HIGH-SPEED PHASE BALANCE

The IR35204 provides phase balance during high frequency load oscillations. The balance is provided through phase skipping. Whenever a set error voltage threshold and load oscillation frequency threshold are exceeded for a particular phase, that phase is skipped, resulting in a lowering of current in the skipped phase and a corresponding increase in current in the other phases. Both these thresholds, listed in Table 20, are user programmable, to provide flexibility in high-speed phase balance for a wide variety of systems. In addition, the IR35204 allows the user to disable HSPB by resetting a bit in MTP.

TABLE 20: HIGH-SPEED THRESHOLDS

Register	Function
Hspb_enable	Dedicated bit to enable/disable HSPB. Resetting this bit will result in the HSPB function not being activated, regardless of the error voltage or load oscillation frequency settings.
Hspb_hth	Error Voltage threshold. Activates HSPB when the threshold is exceeded. <b>0mV – 60mV, 4mV resolution</b>
Hspb_fth	Load Oscillation Frequency Threshold. Activates HSPB when the load oscillation frequency is above threshold. <b>0kHz – 703.5kHz, 46.9kHz resolution.</b>

### DYNAMIC VID SLEW RATE

The IR35204 provides the VR designer 16 fast slew rates each of which can be further configured to 4 different slow slew rates by selecting a slew rate setting as shown. These slew rates can be further reduced 1/2, 1/4, 1/8, and 1/16

TABLE 21: SLEW RATES

mV/ µs	Fast Rate	x 1/2 Factor	x 1/4 Factor	x 1/8 Factor	x 1/16 Factor
	10	5.0	2.50	1.25	0.0625
15	7.5	3.75	1.875	0.94	
20	10	5.00	2.50	1.25	
25	12.5	6.25	3.125	1.56	
30	15	7.5	3.75	1.88	
35	17.5	8.75	4.375	2.19	
40	20	10	5.0	2.5	
45	22.5	11.25	5.625	2.81	
50	25	12.5	6.25	3.125	
55	27.5	13.75	6.875	3.4375	
60	30	15	7.5	3.75	
65	32.5	16.25	8.125	4.0625	
70	35	17.5	8.75	4.375	
80	40	20	10	5	
85	42.5	21.25	10.625	5.3125	
95	47.5	23.75	11.875	5.9375	

**Note:** The maximum DVID rate is limited by the inductor current available to charge the output capacitors. High DVID rates may not be possible if the output capacitor and inductor combination does not allow the output voltage to change at the selected rate.

### DYNAMIC VID COMPENSATION

The IR35204 can compensate for the error produced by the current feedback in a system with AVP (Active Voltage Positioning) when the output voltage is ramping to a higher voltage. An output capacitance term and an AVP bandwidth term are provided in the MTP registers to help model the effects of variation in output voltage during a voltage ramp, due to the inrush current seen by the output bulk capacitors. Once properly modeled, the output voltage will follow the DAC more closely during a positive dynamic VID, and provide better dynamic VID alert timing, as required by Intel® processors. Figure 32 shows the effects that Dynamic VID Compensation has on the output voltage and the alert timing.

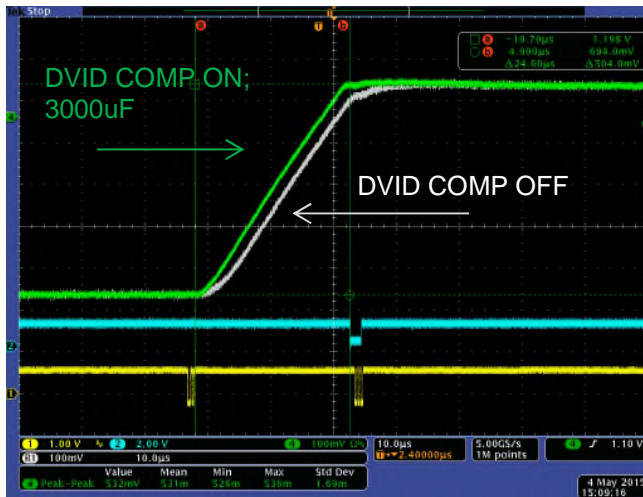

Figure 32: Dynamic VID Compensation

### EFFICIENCY SHAPING

In addition to CPU-specified Power States, the IR35204 features Efficiency Shaping Technology that enables VR designers to cost-effectively maximize system efficiency. Efficiency Shaping Technology consists of Dynamic Phase Control to achieve the best VR efficiency at a given cost point.

### POWER-SAVING STATES

The IR35204 uses Power States to set the power-savings mode. These are summarized in Table 22.

TABLE 22: POWER STATES

Power State	Mode	Recommended Current
PS0	Full Power	Maximum
PS1	Light Load 1-2Φ	<20A
PS2	1Φ Active Discontinuous (Diode Emulation)	<5A
PS3	1Φ Passive Discontinuous (Diode Emulation)	<1A
PS4	Output Voltage DVID or Decay Down to zero depending upon configuration in "ps4_dvid_or_decay" register. PWM signals of all phases are tristated.	Near OFF

The Power States may be commanded through I2C/PMBus, the SVID interface, or the IR35204 can autonomously step through the Power States based

upon the regulator conditions as summarized in Table 23. PS4 can only be commanded with an SVID command

### IVID REGISTER

IVID efficiency registers are a new addition to the family of SVID registers of the IMVP8 specification. When sent an SVID command associated with IVID registers, IR35204 acknowledges the command and stores the received information into the IVID registers. However, IR35204 does not use the information received in IVID registers for any purpose. Instead, it uses the user set-up phase shed function to optimize the VR's efficiency across the entire operating current range.

Table 23: Power State Entry/Exit

	Command Mode	Auto Mode
PS1 Entry	a) Command	n/a if Phase Shed enabled
PS1 Exit	a) Command to PS0 b) DVID to PS0 c) Current limit to PS0	n/a if Phase Shed enabled
PS2 Entry	a) Command	Current level in 1Φ
PS2 Exit	a) Command to PS1/0 b) DVID to PS0 c) Current limit to PS0	Fsw > Fsw_desired to PS0, DVID to PS0, Current limit to PS0
PS3 Entry	a) Command	Current level in 1Φ
PS3 Exit	a) Command to PS2/1/0 b) DVID to PS0 c) Current limit to PS0	Fsw > Fsw_desired to PS0, DVID to PS0, Current limit to PS0
PS4 Entry	a) Command	n/a
PS4 Exit	a) In Single Mode- Any SVID Clock Toggle. b) In Multi Mode – Any SetVID Command	n/a

### DYNAMIC PHASE CONTROL (DPC) IN PS0

IR35204 optionally supports the ability to autonomously adjust the number of phases with load current, thus optimizing efficiency over a wide range of loads.

The output current level at which a phase is added can be programmed individually for each phase for optimum results (Table 24).



TABLE 24: DPC THRESHOLDS

Register (2A steps)	Function
Phase1_thresh	2Φ when I > Phase1_thresh
Phase2_delta	3Φ when I > Phase1_thresh + Phase2_delta
Phase3_delta	4Φ when I > Phase1_thresh + Phase2_delta+Phase3_delta

As shown in Figure 33 (loop one, 3-phase example shown), the designer can configure the VR to dynamically add or shed phases as the load current varies. Both control loops of the IR35204 have the DPC feature.

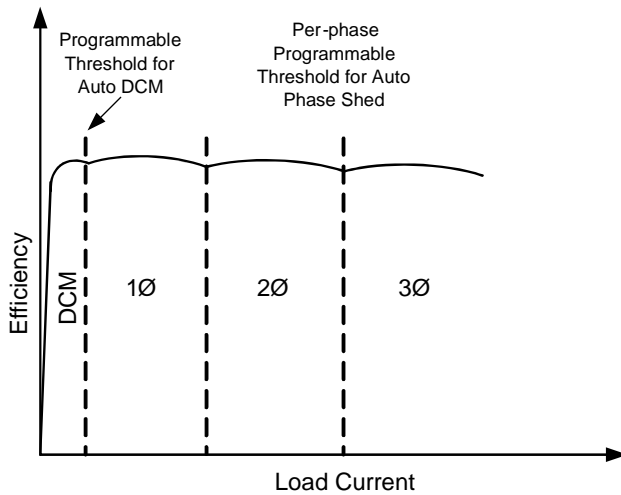

Figure 33: Dynamic Phase Control Regions

The IR35204 Dynamic Phase Control reduces the number of phases (Figure 34) based upon monitoring both the filtered total current and the error voltage over the DPC filter window. Monitoring the error voltage insures that the VR does not drop phases during large load oscillations.

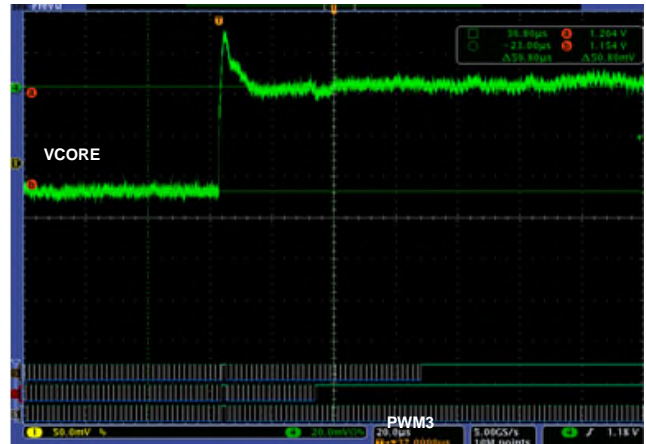

Figure 34: Phase Shed 3Φ→1Φ

During a large load step, and based on the error voltage, the controller instantly goes to the maximum programmed number of phases. It remains at this level for a period equivalent to the DPC filter delay, after which phases get dropped depending on the load current. The Dynamic Phase Control (DPC) algorithm is designed to meet customer specifications even if the VR experiences a large load transient when operating with a lower number of phases. The ATA circuitry ensures that the idle phases are activated with optimum timing during a load step as shown in Figure 35 and Figure 36 below.

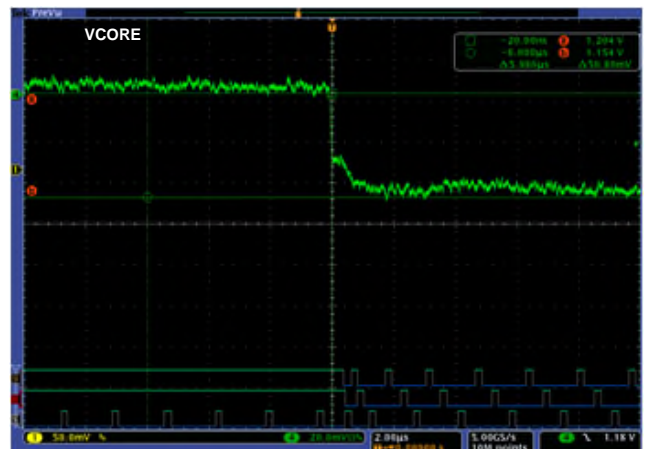

Figure 35: Phase Add 1Φ→3Φ

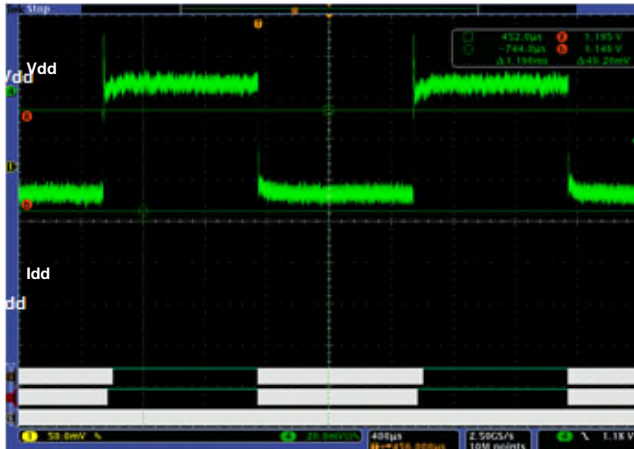

Figure 36: Zoomed-out view of Phase Shed/Add

Current limit and current balancing circuits remain active during ATA events to prevent inductor saturation and maintain even distribution of current across the active phases.

The add/drop points for each phase can be set in 2A increments from 0 to 62A per phase, with a fixed 4A hysteresis. This results in a uniform per-phase current density as the load increases or decreases.

Having DPC enabled optimizes the number of phases used in real time, resulting in significant light and medium-load efficiency improvements, as shown in Figure 37.

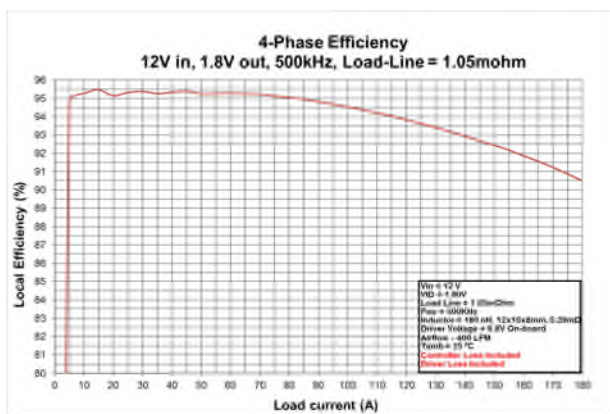

Figure 37: Light Load Efficiency Improvement with DPC

**VARIABLE FREQUENCY WITH LOAD ON LOOP1**

In addition, the controller can be made to operate at a high frequency when only a few phases are running, and lower the frequency as more phases are added. This skew feature is based on monitoring the per-phase current. The different skews of the switching frequency available are:

TABLE 25: SWITCHING PERIOD SKEW FACTOR OPTIONS

Switching Period Skew Range	Per-Phase Starting Current (A)
Fsw to 2 x Fsw	8
Fsw to 2 x Fsw	12
Fsw to 2 x Fsw	16
Fsw to 0.5 x Fsw	8
Fsw to 0.5 x Fsw	12
Fsw to 0.5 x Fsw	16

Note: Per Phase Current is limited to 62A in normal mode, 124A in doubler mode.

Using the above feature, the switching frequency can be skewed based on the different register settings and per-phase currents – the switching frequency skew factor versus per-phase currents have been plotted in Figure 38 below for 3 of the register settings for reference.

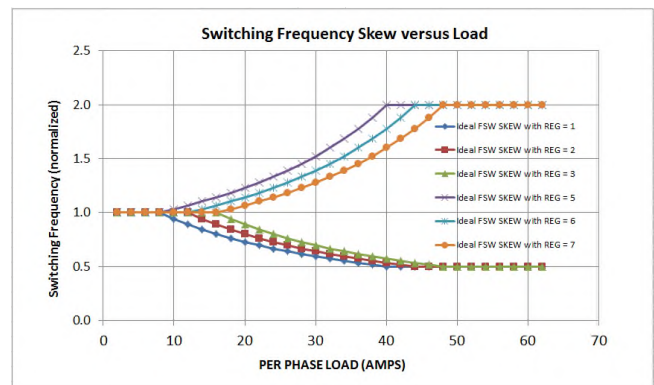

Figure 38: Normalized Switching Frequency

**DISCONTINUOUS MODE OPERATION - PS2, PS3**

Under very light loads, the VR efficiency is dominated by MOSFET switching losses. In PS2 mode, the IR35204 operates as a constant on-time controller where the user sets the desired peak-to-peak ripple by programming an error threshold and an on-time duration (Table 26). PS3 operation is identical to PS2, with the additional ability to disable the internal current sense amplifiers within the controller for further reduction in power consumption.

TABLE 26: PS2/PS3 MODE CONSTANT ON-TIME CONTROL

MTP Register	Function
ni_thresh	Sets the current level below which PS2/PS3 is entered.
de_thresh	Sets the error threshold to start a pulse

	during diode emulation, in 3mV resolution.
<b>de_pw</b>	Sets the duration of the ON time pulse in 40ns steps during diode emulation.
<b>off_time_adj</b>	Reduces the calculated low-side FET ON time during diode emulation in 60ns steps. Useful for compensating for DrMOS or other drivers' tri-state delay for better zero-crossing prediction.

In PS2 mode (Active Diode Emulation Mode), the internal circuitry estimates when the inductor current declines to zero on a cycle-by-cycle basis, and shuts off the low-side MOSFET at an appropriate time in each cycle (Figure 39). This effectively lowers the switching frequency, resulting in lowered switching losses and improved efficiency.

Industry standard tri-state drivers typically have delays when entering tri-state, typically 150ns to 300ns, which allows negative current to build up, causing switch node ringing and reducing efficiency.

The off\_time\_adj variable allows for compensation of the tri-state delay by reducing the low-side FET on-time by an equivalent amount.

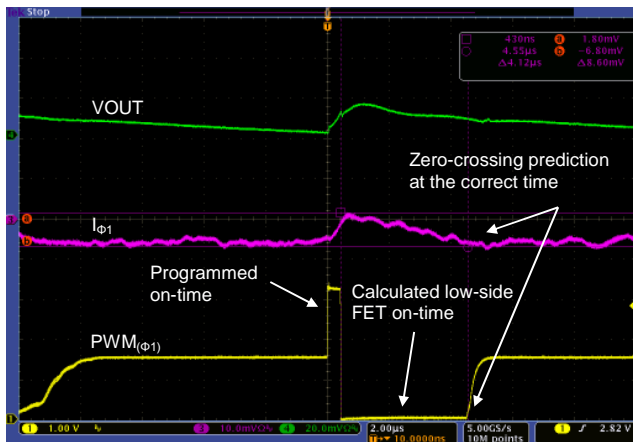

**Figure 39: PS2 Active Diode Emulation Mode**

**PS4 MODE**

The IR35204 controller supports the PS4 command but does not reduce controller power consumption .

When a valid PS4 command is received by the controller, the IR35204 does the following:

- Acknowledge the command.
- Output voltage is DVID or Decay down to 0 Vdc depending upon the configuration in “ps4\_dvid\_or\_decay” register.
- PWM signals of all phases are tristated.

The controller does not shutdown the circuitry for lowest power consumption.

PS4 wake up can be set to wake on any SVID clock or alternatively on any SVID Set\_VID or SetPS0/1/2/3 command.

**PS4 REGISTER SUPPORT**

IR35204 controller supports SVID register “PS4 Exit Latency” (2B). This register holds the encoded value for PS4 exit latency calculated as

$$Latency (\mu S) = \frac{x}{16} * 2y$$

Where x =bits[3:0], y = bits[7:4]

**FAULTS & PROTECTION**

The comprehensive fault coverage of the IR35204 protects the VR against a variety of fault conditions. Faults can be configured and monitored through the IR PowIRCenter GUI. There are two types of fault monitoring registers. In addition to real-time fault registers, there are “sticky” fault registers that can only be cleared with an I2C command or 3.3V power cycle. These will indicate if any fault has occurred since the last power cycle, even if the fault has cleared itself and the VR has resumed normal operation. Table 27 lists the available faults.

**TABLE 27: STICKY & NON-STICKY FAULTS**

Register Type	Faults
Sticky	OTP, OCP, OVP, UVP, VIN UVLO, 3.3V UVLO, phase-fault, slow-OCP
Non-Sticky	

**Output Over-voltage Protection (OVP)**

If the output voltage exceeds a user-programmable threshold (Table 32) above the VID set-point, the IR35204 detects an output over-voltage fault and latches ON the low-side MOSFETS to limit the output voltage rise.

**TABLE 28: OVP ACTION**

OVP Action
Low-side MOSFET latched on
Low-side MOSFET on until Output<0.248V

Per Table 28 above, the low-side MOSFETS may be configured to either latch ON indefinitely (Figure 40) or stay

ON until the output voltage falls below the release threshold (Figure 41), in case of an over-voltage condition. This release mode reduces the undershoot of the output voltage during recovery from an OVP condition. If the output voltage rises above the OVP threshold during recovery, the low side MOSFET's will again be turned on until Vout drops below the release threshold level. *Note that OVP is disabled during a DVID-down event to prevent false triggering.*

During soft-start, OVP is triggered at a user-selectable level from one of the thresholds listed in Table 29 below.

TABLE 29: OVP THRESHOLDS DURING START-UP

Value	Threshold
0	2.5V
1	1.2V
2	1.275V
3	1.35V

The IR35204 also provides the option to allow OVP to remain active when the device is disabled, in order to prevent system leakage from causing over-voltage on the output (Table 30).

*Note: OVP functionality is only available when both the controller and drivers or power stages have Vcc power.*

TABLE 30: OVP OPTIONS

OVP_when-disabled setting	When active
On	IC disabled & IC enabled
Off	IC enabled

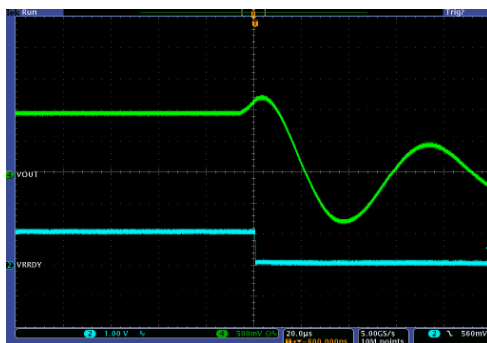

Figure 40: OVP - MOSFET latched on

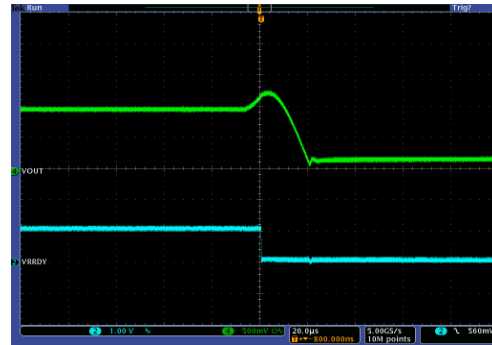

Figure 41: OVP - MOSFET released when output < 0.3V

**Output Under-voltage Protection (UVP)**

The IR35204 detects an output under-voltage condition if the sensed voltage at the CPU is below the user-programmable UVP threshold (Table 32) or a fixed 248mV (if the ADC detection is used instead of the comparator), as shown in Table 31.

TABLE 31: UVP THRESHOLD OPTIONS

Use the common comparator
Use the ADC

The user also has the option to choose if the threshold needs to factor in the load line or not. Upon detecting an output under-voltage condition, the IR35204 responds in the same manner as the OCP, according to the setting selected in Table 33.

TABLE 32: OVP & UVP THRESHOLDS

Value	Threshold
0	50mV
1	100mV
2	150mV
3	200mV
4	250mV
5	300mV
6	350mV
7	400mV

**Over-current Protection (OCP)**

The IR35204 provides a programmable output over-current protection threshold of up to 62A per phase. This would translate to an overall maximum system OCP threshold of 62A times the number of phases.

The controller action during an OCP event can be configured as shown in TABLE 33. *Note that the OCP protection is disabled during start up and during VID transitions. Also, the threshold scales by a factor of 2x in the doubler mode and 4x in the quad mode.*

TABLE 33: OCP & UVP MODE SELECTION

OCP/UVP Behavior Mode
Per phase OCP Threshold (0 to 62A)
Shutdown immediately (cycle power or enable to restart)
Hiccup 2X before Shutdown
Hiccup indefinitely

### Slow Current Limit

In addition to the (fast) OCP, a Slow Current Limit can be programmed to monitor and protect against the thermal effects of the average current over time. This allows the system designer to operate close to the TDP level of the system. The slow current limit bandwidth is set by the telemetry bandwidth to one of the following options:

TABLE 34: TELEMETRY BANDWIDTH SETTING OPTIONS

Value	Bandwidth (Hz)
0	0.69
1	1.39
2	2.78
3	5.55
4	11.1
5	22.2
6	44.6
7	89.5

When the slow OCP threshold is exceeded, the VR will shut down based upon the OCP mode programmed in the MTP.

*Note that the slow OCP protection is disabled during start up and during VID transitions.*

### VR\_HOT and Over Temperature Protection (OTP)

The IR35204 provides a temperature measurement capability at the TSEN pin that is used for over temperature protection, VR\_HOT flag and temperature monitoring. The temperature is measured with either an NTC network or by monitoring IR PowIRstage temperature reporting outputs. Sense

devices need to be placed close to the thermal hot spot for optimal performance. The thresholds are programmable in 1°C increments within the range shown in Table 35. If the measured temperature exceeds the OTP threshold, the IR35204 will latch off the VR, requiring a system power recycle or an ENABLE recycle to resume operation.

TABLE 35: VR\_HOT & OTP

Function
VR_HOT threshold (64°C to 127°C)
OTP threshold (VR_HOT + 0°C to 32°C) max 135°C MAX 158C with IR3555 temp sense

### NTC Temperature Sense

The IR35204 includes a pre-programmed look-up table that is optimized for the recommended NTC options shown in Table 36. The NTC network is connected to the TSEN pin as shown in Figure 42.

A 0.01μF capacitor is recommended for filtering when used with the NTC sense network.

TABLE 36: NTC TEMPERATURE SENSE RANGE

NTC	Value	R <sub>parallel</sub>
Murata NCP15WB473F03RC or Panasonic ERT-J0EP473J	47KΩ	13KΩ

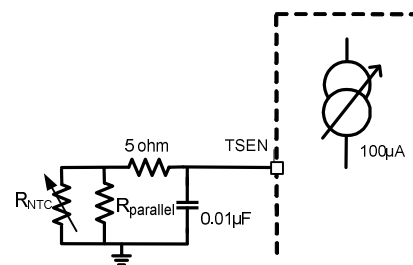

Figure 42: Temperature Sense NTC Network

### IR Power Stage Temperature Sense

The controller is designed to interface to the IR3555 power stage to receive temperature and fault information from the IR3555 power stage. The power stage temperature output is scaled to 8mV/C and a 1:1.64 divider is required to scale this down to the 4.88mV/C gain of the controller input as shown in Figure 43. Fault communication from the IR3555 is a 3.3Vdc high. The 3.3Vdc high from the power stage

indicates either 1) a power stage phase fault, 2) an over temperature, 3) a persistent overcurrent or 4) an over voltage condition. The controller will shut down and assert the CAT\_FLT pin (high) upon receiving the power stage fault.

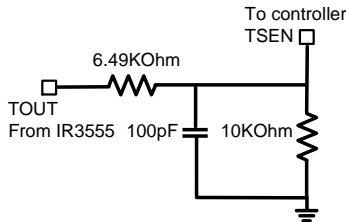

Figure 43: Temperature Sense IR Power Stage Network

### VR\_HOT\_ICRIT Pin Functionality Options

The functionality of the VR\_HOT\_ICRIT pin can be set to assert when levels of Temp\_max, Icc\_max, and/or OCP levels are exceeded. Table 37 shows the multiple configurations of the VR\_HOT\_ICRIT pin.

TABLE 37: VR\_HOT\_ICRIT PIN OPTIONS

Temp_max Only
Temp_max or Icc_max
Temp_max or OCP
Icc_max Only

### Icritical Flag

The IR35204 VR\_HOT\_ICRIT pin can optionally be programmed to assert when a user programmable output current level is exceeded. The assertion is not a fault, and the VR continues to regulate. I\_CRITICAL monitors a long term averaged output current, which is a useful indicator of average operating current and thermal condition. The user can select between the I\_CRITICAL filters bandwidths shown in Table 38.

TABLE 38: I\_CRITICAL OVER-CURRENT OPTIONS

Value	Bandwidth (Hz)
0	0.69
1	1.39
2	2.78
3	5.55
4	11.1
5	22.2
6	44.6

7	89.5
---	------

I\_CRITICAL has a 5% hysteresis level and the VR\_HOT\_ICRIT pin will de-assert when the average output current level drops below 95% of the programmed current level threshold.

### Input Over-voltage Protection

The IR35204 offers protection against input supply over-voltage. When enabled (Table 39), the VINSEN pin is compared to a fixed threshold of 14.5V with a 14:1 divider, and shuts down the IC if the threshold is exceeded.

TABLE 39: INPUT OVER-VOLTAGE OPTIONS

disabled
enabled

### Phase Faults

The IR35204 can detect and declare a phase fault when the current in one or more phases is too high or too low. It detects the fault when the duty cycle of a particular phase is 5% higher or lower than the average duty cycle of all the phases. This feature helps detect severe imbalances in the phase currents, an unpowered or damaged MOSFET driver, or a phase that is disconnected from Vin. The phase fault feature can be enabled or disabled through an MTP bit. When a phase fault occurs, the controller shuts down the loop where the fault occurred, and sets register bits to display which phase had the fault and whether it faulted high or low. The phase fault registers are cleared via a register bit and the VR will restart once ENABLE or Vcc is cycled.

TABLE 40: PHASE FAULT REGISTERS

Register	Function
pi_fault_en	Enables phase current fault shutdown.
clear_phase_faults	Clears all phase faults for each loop.
pi_fault	Indicates which phase has a phase current fault. 0 – phase1, 1 – phase2, 2 – phase3, 3 – phase4...7-phase 8
max_cond	Indicates one or more phase currents are too high.
min_cond	Indicates one or more phase currents are too low.

### I2C/PMBUS COMMUNICATION

The IR35204 simultaneously supports I2C and PMBus through the use of exclusive addressing. This means that a motherboard PMBus master may communicate with as many as 127 IR35204-based VRs. Optionally, a resistor offset can be enabled as shown in Table 41 (note that a 0.01µF capacitor is required across the resistor per Figure 44), with the offsets shown in Table 42.

As an example, setting a base 7-bit I2C address of 28h with a resistor offset of +15 sets the 7-bit I2C address to 37h. Similarly setting a base 7-bit PMBus address of 40h with a resistor offset of +15 sets the 7-bit PMBus address to 4Fh.

The IR35204 can also set the I2C address independently from the PMBus address. By using a 7-bit address the user can configure the device to any one of 127 different I2C addresses.

Once the address of the IR35204 is set, it is locked to protect it from being overridden.

For default programmed devices, the I2C/PMBus address can be temporarily forced to address 0Ah for I2C and 0Dh for PMBus by setting EN=VR\_HOT=low.

**TABLE 41: I2C OFFSET OPTIONS**

Enable_I2C Addr_Offset MTP bit	I2C Address Offset
0	disabled
1	enabled

**TABLE 42: ADDR RESISTOR OFFSET**

ADDR Resistor	I2C Address Offset
0.845kΩ	+0
1.30kΩ	+1
1.78kΩ	+2
2.32kΩ	+3
2.87kΩ	+4
3.48kΩ	+5
4.12kΩ	+6
4.75kΩ	+7
5.49kΩ	+8
6.19kΩ	+9

ADDR Resistor	I2C Address Offset
6.98kΩ	+10
7.87kΩ	+11
8.87kΩ	+12
10.00kΩ	+13
11.00kΩ	+14
12.10kΩ	+15

Note: Extends the range of PMBus addresses.

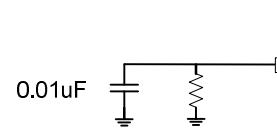

**Figure 44: ADDR pin components**

**REAL-TIME I2C MONITORING FUNCTIONS**

IR35204 provides real-time accurate measurement of input voltage, input current, output voltage, output current and temperature over the I2C interface. Output voltage is calculated based upon the VID setting and load line, and the result is reported through the I2C.

**Accuracy Optimization Registers**

The IR35204 provides excellent factory-trimmed chip accuracy. In addition, the designer has calibration capability that can be used to optimize reporting accuracy for a given design, with minimum component changes. Once a design is optimized, the IR35204 provides excellent repeatability from board to board. The IR35204 also provides capability for individual board calibration and programming in production for best accuracy. Table 43 shows the MTP registers used to fine tune the accuracy of the reported measurements. Figure 45 to Figure 47 show the typical accuracy of the output current, input voltage and output voltage measurements using the IR35204.

**TABLE 43: ACCURACY OPTIMIZATION REGISTERS**

NVM Register	Function
IIN Fixed Offset	Offsets the input current in 1/32A steps.

<b>IIN Per Phase Offset</b>	Offsets the input current dependent upon the number of active phases in 1/128A steps e.g. the drive current for the MOSFET's. This current increases every time a new phase is added.
<b>IOUT Current Offset</b>	Offsets the output current from -2A to +1.875A per phase in 0.125A steps
<b>Vout Offset</b>	Offsets the output voltage +40mV to -35mV in 5mV steps (Intel® VR12 mode), or +80mV to -70mV in 10mV steps (Intel® VR12.5 mode).
<b>Temperature Offset</b>	Offsets the temperature +31°C to -32°C in 1°C steps to compensate for offset between the hottest component and the NTC sensing location.
<b>Duty Cycle Adjust</b>	Adjusts the input current calculation to compensate for a non-ideal driver.

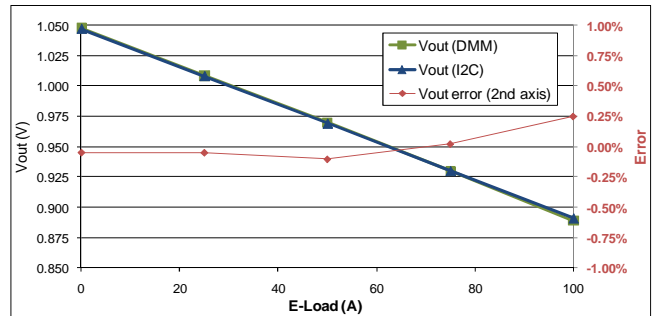

Figure 47: I2C Output Voltage Measurements

### I2C SECURITY

The IR35204 provides robust and flexible security options to meet a wide variety of customer applications. A combination of hardware pin and software passwords prevent accidental overwrites, discourages hackers, and secures custom configurations and operating data. The Read and Write Security can be set in MTP (Table 44 and Table 45) with the protection methods shown in Table 46.

TABLE 44: READ SECURITY

No Protection
Configuration Registers Only
Protect All Registers But Telemetry
Protect All

TABLE 45: WRITE SECURITY

No Protection
Configuration Registers Only
Protect All

TABLE 46: READ OR WRITE UNLOCK OPTIONS

Password Only
Pin Only
Pin & Password
Lock Forever

### Password Protection

The system designer can set any 16-bit password (other than 00h). This password is stored in MTP. To unlock, a user must write the correct password into

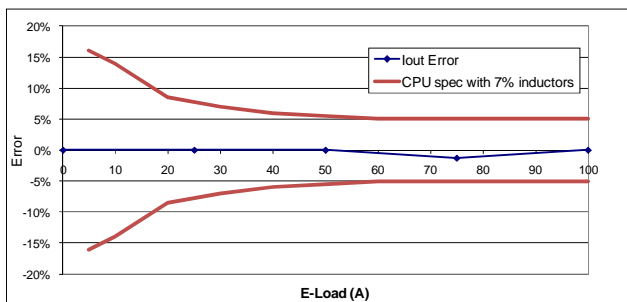

Figure 45: I2C I<sub>OUT</sub> Error using 10% DCR Inductors

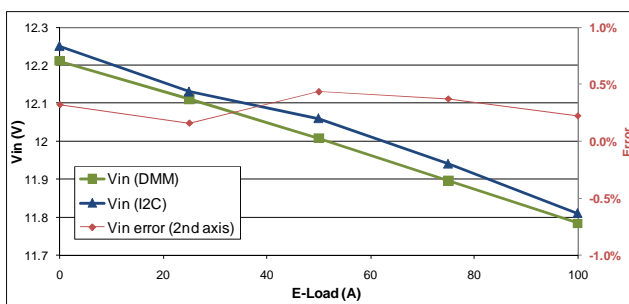

Figure 46: I2C Input Voltage Measurements



the “Password Try” register, which is a volatile read/write register. After four incorrect tries, the IC will lock up to prevent unauthorized access.

TABLE 47: PASSWORD REGISTERS

Register	Length	Location
Password	16 bit (2 bytes)	MTP
Try	16 bit (2 bytes)	R/W

The following pseudo-code illustrates how to change a password:

```
# first unlock the IC
Write old password high Byte to R/W high Byte Try register
Write old password low Byte to R/W low Byte Try register

# now write new password into MTP
Write new password high Byte to high Byte Password register

# password has changed! Must unlock to change the low byte
Write new password high Byte to R/W high Byte Try register
Write new password low Byte to low Byte Password register

# password change complete, status is locked

# Need to write new low byte to Try register to unlock
```

### Pin Protection

The ADDR/PROTECT pin is a dual function pin. When the IC is enabled, the resistor value is latched and stored for use in the I2C address offset function. Thereafter, the pin acts entirely as a PROTECT pin. If enabled, the PROTECT pin must be driven high to unlock and low to lock. If the resistor address offset function is being used, care must be taken to allow the IC to read the resistor value before driving the pin high or low to set the security state. Failure to follow this precaution may result in an erroneous address offset value being latched in. The user should at least wait until the completion of the auto-trim time  $t_4$  in Figure 6.

### Min/Max Registers

Min/Max registers for IOUT, IIN, VOUT, VIN, and TEMPERATURE are available. The data is read by setting a pointer and reading the value from a register that contains the minimum and maximum data. These registers store high and low values from startup or the last read, whichever was the latest to occur. The registers are automatically cleared when the data is read back from the controller

The minmax\_sel[4:0] register is the pointer used to select the appropriate signal and the minmax\_val[7:0] register will show the min or max value of what has been selected. The list of available min/max values, bandwidth, and resolutions are shown in Table 50.

TABLE 50: MIN/MAX REGISTER SETTINGS

Pointer Value	Reading	Signal bandwidth	Resolution of reading value
0	loop_1_current_min	62 KHz/ 3.93 KHz (based on minmax_output_i_bw)	2A
1	loop_1_current_max		
2	loop_2_current_min		0.5A
3	loop_2_current_max		
4	loop_1_input_current_min	102Hz	0.125A
5	loop_1_input_current_max		
6	loop_2_input_current_min		0.0625A
7	loop_2_input_current_max		
8	loop_1_output_voltage_min	Telemetry_bw	0.0625V
9	loop_1_output_voltage_max		
10	loop_2_output_voltage_min		
11	loop_2_output_voltage_max	760Hz	0.125V
12	input_voltage_min		
13	input_voltage_max	Telemetry_bw	1 C
14	temp1_min		
15	temp1_max	Telemetry_bw	1 C
16	temp2_min		
17	temp2_max		

### AMD SVI2 MODE

When the power-on sequence is initiated, both rails will ramp to the configured Vboot voltage and assert the PWRGD on each loop. The soft-start occurs at the 1/2 or 1/4 multiplier slew rate as selected in Table 51.

TABLE 51: SLEW RATES

mV/μs	FAST rate	1/2 Multiplier	1/4 Multiplier
	10	5.0	2.50
15	7.5	3.75	
20	10	5.00	
25	12.5	6.25	

The boot voltage is decoded from the SVC and SVD levels when the EN pin is asserted high as shown in

Table 52. This value is latched and will be re-used in the event of a soft reset (de-assertion and re-assertion of PwrOK).

**Note: VCC and VDDIO must be stable for a minimum 5ms before the IC is enabled to ensure that the Boot voltage is decoded from the SVC, SVD pins correctly.**

TABLE 52: AMD SVI BOOT TABLE

Boot Voltage	SVC	SVD
1.1V	0	0
1.0V	0	1
0.9V	1	0
0.8V	1	1

Alternatively, the AMD boot voltage can be set by an MTP register instead of decoding the SVC, SVD pins as shown in Table 53. Boot values are shown in Table 54.

TABLE 53: AMD BOOT OPTIONS

MTP Boot Register	Boot Location
Bit[7] = low	Decode from SVC, SVD pins per Table 52
Bit[7] = high	Use MTP boot register bits [6:0]

### PWROK De-assertion

The IR35204 responds to SVI commands on the SVI bus interface when PWROK is high. In the event that PWROK is de-asserted the controller resets the SVI state machine, drives the SVT pin high and returns to the Boot voltage, initial load line slope and offset.

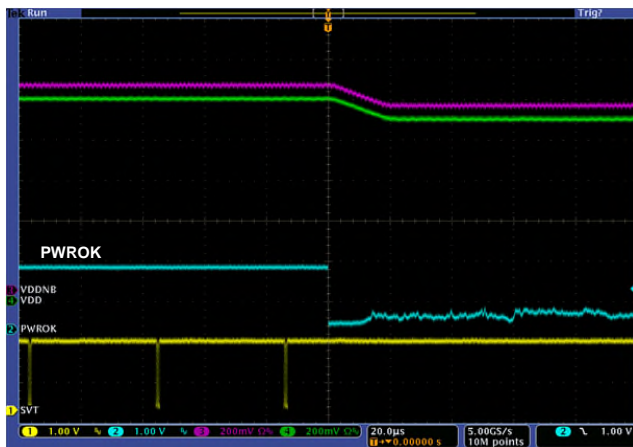

Figure 49: PWROK De-assertion

The IR35204 implements a fully compliant AMD SVI2 Serial VID interface (SVI). SVI2 is a three-wire interface between a SVI2 compliant processor and a VR. It consists of clock, data, and telemetry/alert signals. The processor will send a data packet with the clock (SVC) and data (SVD) lines. This packet has SVI commands to change VID, go to a low power state, enable and configure telemetry, change load line slope and change VID offset. The VR, when configured to do so, will send telemetry to the processor. The telemetry data consists of voltage only, or voltage and current of each output rail (VDD, VDDNB). The telemetry line (SVT) is also used as an alert signal (VOTF complete) to alert the processor when a positive going VID change is complete, or an offset or load line scale change has occurred.

### VID Change

The IR35204 accepts an 8-bit VID within the SVD packet and will change the output voltage at the FAST rate specified in Table 51 of one or both of the loops based on the VID in Table 54. This is a VID-on-the-fly-request (VOTF Request).

### SVI2 Interface

TABLE 54: SVI2 VID TABLE

VID (Hex)	Voltage (V)	VID (Hex)	Voltage (V)	VID (Hex)	Voltage (V)	VID (Hex)	Voltage (V)	VID (Hex)	Voltage (V)
0	1.55000	32	1.23750	64	0.92500	96	0.61250	C8	0.30000
1	1.54375	33	1.23125	65	0.91875	97	0.60625	C9	0.29375
2	1.53750	34	1.22500	66	0.91250	98	0.60000	CA	0.28750
3	1.53125	35	1.21875	67	0.90625	99	0.59375	CB	0.28125
4	1.52500	36	1.21250	68	0.90000	9A	0.58750	CC	0.27500
5	1.51875	37	1.20625	69	0.89375	9B	0.58125	CD	0.26875
6	1.51250	38	1.20000	6A	0.88750	9C	0.57500	CE	0.26250
7	1.50625	39	1.19375	6B	0.88125	9D	0.56875	CF	0.25625
8	1.50000	3A	1.18750	6C	0.87500	9E	0.56250	D0	0.25000
9	1.49375	3B	1.18125	6D	0.86875	9F	0.55625	D1	0.24375
A	1.48750	3C	1.17500	6E	0.86250	A0	0.55000	D2	0.23750
B	1.48125	3D	1.16875	6F	0.85625	A1	0.54375	D3	0.23125
C	1.47500	3E	1.16250	70	0.85000	A2	0.53750	D4	0.22500
D	1.46875	3F	1.15625	71	0.84375	A3	0.53125	D5	0.21875
E	1.46250	40	1.15000	72	0.83750	A4	0.52500	D6	0.21250
F	1.45625	41	1.14375	73	0.83125	A5	0.51875	D7	0.20625
10	1.45000	42	1.13750	74	0.82500	A6	0.51250	D8	0.20000
11	1.44375	43	1.13125	75	0.81875	A7	0.50625	D9	0.19375
12	1.43750	44	1.12500	76	0.81250	A8	0.50000	DA	0.18750
13	1.43125	45	1.11875	77	0.80625	A9	0.49375	DB	0.18125
14	1.42500	46	1.11250	78	0.80000	AA	0.48750	DC	0.17500
15	1.41875	47	1.10625	79	0.79375	AB	0.48125	DD	0.16875
16	1.41250	48	1.10000	7A	0.78750	AC	0.47500	DE	0.16250
17	1.40625	49	1.09375	7B	0.78125	AD	0.46875	DF	0.15625
18	1.40000	4A	1.08750	7C	0.77500	AE	0.46250	E0	0.15000
19	1.39375	4B	1.08125	7D	0.76875	AF	0.45625	E1	0.14375
1A	1.38750	4C	1.07500	7E	0.76250	B0	0.45000	E2	0.13750
1B	1.38125	4D	1.06875	7F	0.75625	B1	0.44375	E3	0.13125
1C	1.37500	4E	1.06250	80	0.75000	B2	0.43750	E4	0.12500
1D	1.36875	4F	1.05625	81	0.74375	B3	0.43125	E5	0.11875
1E	1.36250	50	1.05000	82	0.73750	B4	0.42500	E6	0.11250
1F	1.35625	51	1.04375	83	0.73125	B5	0.41875	E7	0.10625
20	1.35000	52	1.03750	84	0.72500	B6	0.41250	E8	0.10000
21	1.34375	53	1.03125	85	0.71875	B7	0.40625	E9	0.09375
22	1.33750	54	1.02500	86	0.71250	B8	0.40000	EA	0.08750
23	1.33125	55	1.01875	87	0.70625	B9	0.39375	EB	0.08125
24	1.32500	56	1.01250	88	0.70000	BA	0.38750	EC	0.07500
25	1.31875	57	1.00625	89	0.69375	BB	0.38125	ED	0.06875

VID (Hex)	Voltage (V)	VID (Hex)	Voltage (V)	VID (Hex)	Voltage (V)	VID (Hex)	Voltage (V)	VID (Hex)	Voltage (V)
26	1.31250	58	1.00000	8A	0.68750	BC	0.37500	EE	0.06250
27	1.30625	59	0.99375	8B	0.68125	BD	0.36875	EF	0.05625
28	1.30000	5A	0.98750	8C	0.67500	BE	0.36250	F0	0.05000
29	1.29375	5B	0.98125	8D	0.66875	BF	0.35625	F1	0.04375
2A	1.28750	5C	0.97500	8E	0.66250	C0	0.35000	F2	0.03750
2B	1.28125	5D	0.96875	8F	0.65625	C1	0.34375	F3	0.03125
2C	1.27500	5E	0.96250	90	0.65000	C2	0.33750	F4	0.02500
2D	1.26875	5F	0.95625	91	0.64375	C3	0.33125	F5	0.01875
2E	1.26250	60	0.95000	92	0.63750	C4	0.32500	F6	0.01250
2F	1.25625	61	0.94375	93	0.63125	C5	0.31875	F7	0.00625
30	1.25000	62	0.93750	94	0.62500	C6	0.31250	F6-FF	OFF
31	1.24375	63	0.93125	95	0.61875	C7	0.30625		

**PSI[x]\_L and TFN**

PSI0\_L is Power State Indicator Level 0. When this bit is asserted the IR35204 will drop to 1 phase depending on configuration. This will only occur if the output current is low enough (typically <20A) to enter PSIO, else the VR will remain in full phase operation.

PSI1\_L is Power State Indicator Level 1. When this bit is asserted along with the PSI0\_L bit, the IR35204 will enter diode emulation mode. This will only occur if the output current is low enough (typically <5A) to enter PSI1, else the VR will enter PSIO\_L mode of operation.

TFN is an active high signal that allows the processor to control the telemetry functionality of the VR. If TFN=1, then the VR telemetry will be configured per Table 55.

TABLE 55: TFN TRUTH TABLE

VDD, VDDNB Domain Selector bit	Meaning
0, 0	Telemetry is in voltage only mode.
0, 1	Telemetry is in voltage & current mode.
1, 0	Telemetry is disabled.
1, 1	Reserved.

**SVT Telemetry**

The IR35204 has the ability to sample and report voltage and current for the VDD and VDDNB domains. The IR35204 reports this telemetry serially over the SVT wire which is clocked by the processor driven SVC. If in voltage-only telemetry mode then the sampled voltage for VDD and VDDNB are sent together in every SVT telemetry packet at a rate of 20kHz. If in voltage and current mode then the sampled voltage and current for VDD is sent out in one SVT telemetry packet followed by the sampled voltage and current for VDDNB in the next SVT telemetry packet at a rate of 40kHz. The voltage and current are moving averages based on the filters and update rates specified in the Electrical Specification Table. The voltage is reported as a function of the Set VID minus Iout times the Load Line Resistance. The current is reported as a percentage of the Icc\_max register, where a value of FFh represents 100% and 00h represents 0% of the Icc\_max setting. Resolution of the current reporting is 0.39% (1/256).

**Load Line Slope Trim**

The IR35204 has the ability for the processor to change the load line slope of each loop independently through the SVI2 bus while ENABLE and PWROK are asserted via the serial VID interface. The slope change applies to initial load line slope as set by the external RCSP/RCSM resistor network. The load line slope can be disabled or adjusted by -40%, -20%, 0%, +20%, +40%, +60%, or +80%.

**Offset Trim**

The IR35204 has the ability for the processor to change the offset of each loop independently while ENABLE and PWROK are asserted via the serial VID interface. The offset can be left unchanged, disabled, or changed +25mV or -25mV.

**Ispike/Dual OCP Support**

The IR35204 has two current limit thresholds. One threshold is for short duration current spikes (Fast OCP). When this threshold, typically a percentage above the peak processor current, is exceeded, the VR quickly shuts down. The other threshold, typically a percentage above the thermal design current (TDC), is heavily filtered (Slow OCP) and shuts down the VR when the average current exceeds it. To meet AMD specifications, exceeding both thresholds will assert the OCP\_L (VR\_HOT) pin and delay the over-current shut down by 10usec for FAST threshold and 20usec for the SLOW threshold, typically. Figure 50 and Figure 51 show the delay action of the OCP shutdown with the OCP\_L (VR\_HOT) and PWRGD pins.

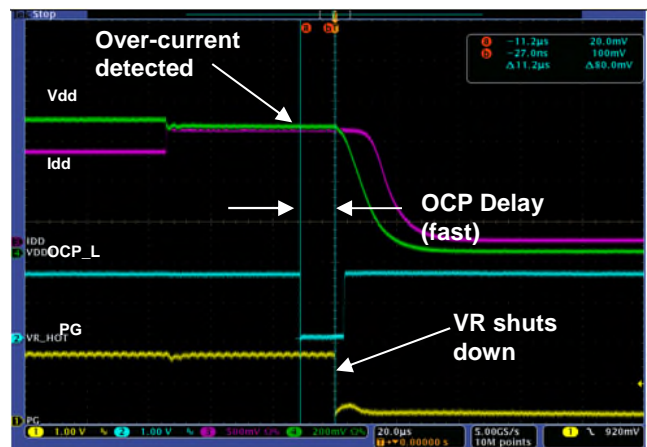

Figure 50: OCP\_L (VR\_HOT) assertion with OCP\_spike (Fast) threshold. OCP delay action (11usec)

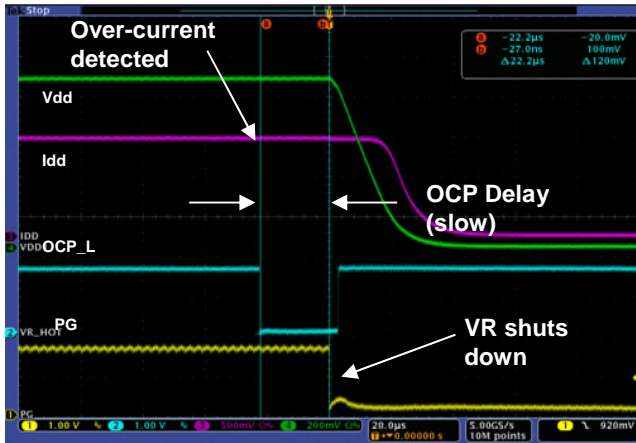

Figure 51: OCP\_L (VR\_HOT) assertion with OCP\_TDC (Slow) threshold. OCP delay action (22µsec)

### Thermal Based Protection

The IR35204 can also assert the PROC\_HOT\_L (VR\_HOT) pin when the temperature of the VR exceeds a configurable temp\_max threshold (typically 100° C). If the temperature continues to rise and exceeds a second configurable threshold (OTP\_thresh) then the VR will shut down and latch off. The VR can only be restarted if ENABLE or VCC is cycled.

### AMD SVI Address Programming

By default, loop 1 is addressed as the VDD rail and loop 2 is addressed as the VDDNB rail which is sufficient for most applications. The IR35204 however, can also be configured with a single bit change to swap this addressing scheme so that loop 1 can be addressed as the VDDNB rail and loop 2 can be addressed as the VDD rail. This is for application where the VDDNB requires more than one phase and VDD only requires one.

## I2C PROTOCOLS

All registers may be accessed using either I2C or PMBus protocols. I2C allows the use of a simple format whereas PMBus provides error checking capability. Figure 52 shows the I2C format employed by the IR35204.

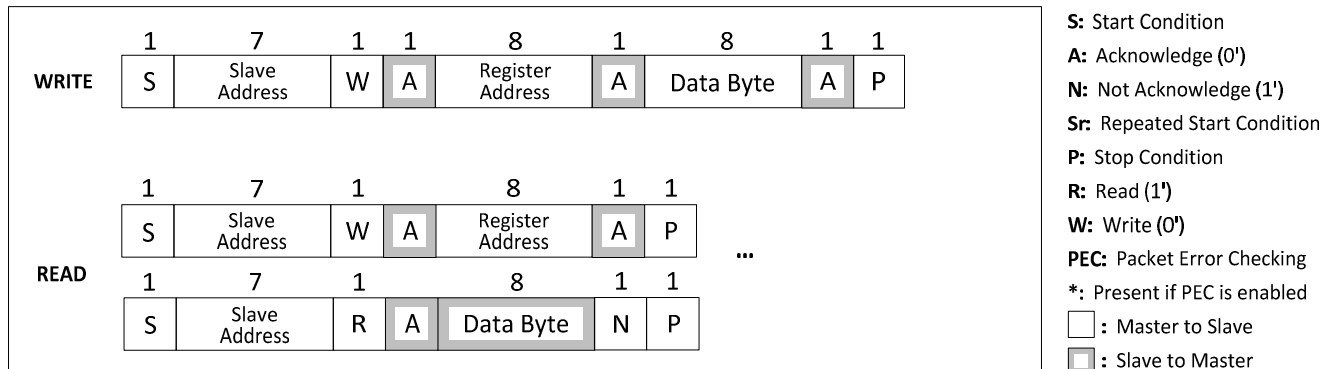

Figure 52: I2C Format

## PMBUS PROTOCOLS

To access IR's configuration and monitoring registers, 4 different protocols are required:

- the PMBus Send Byte protocol with/without PEC (for CLEAR\_FAULTS only)
- the PMBus Read/Write Byte/Word protocol with/without PEC (for status and monitoring)
- the PMBus Block Read and Block Write protocols with Byte Count = 1 and Byte Count = 2
- the PMBus Block Read Process call (for accessing Configuration Registers)

An explanation of which command codes and protocols are required to access them is given in Table 6. In addition, the IR35204 supports:

- Alert Response Address (ARA)
- Bus timeout (30ms)
- Group Command for writing to many VRs within one command

**LEGEND:**

- S: Start Condition
- A: Acknowledge(0')
- N: Not Acknowledge(1')
- Sr:
- P: Stop Condition
- R: Read(1')
- W: Write(0')
- PEC: Calculated from Command
- \*: Data is optional
- : Master to Slave
- : Slave to Master

Note: PEC is required for the  
 MFR\_READ\_REG command

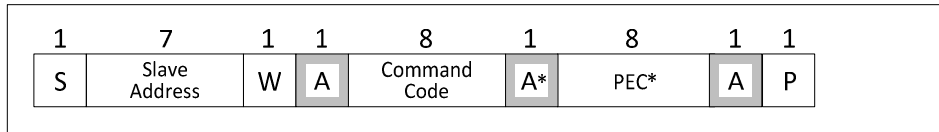

**Figure 53: PMBus Send Byte**

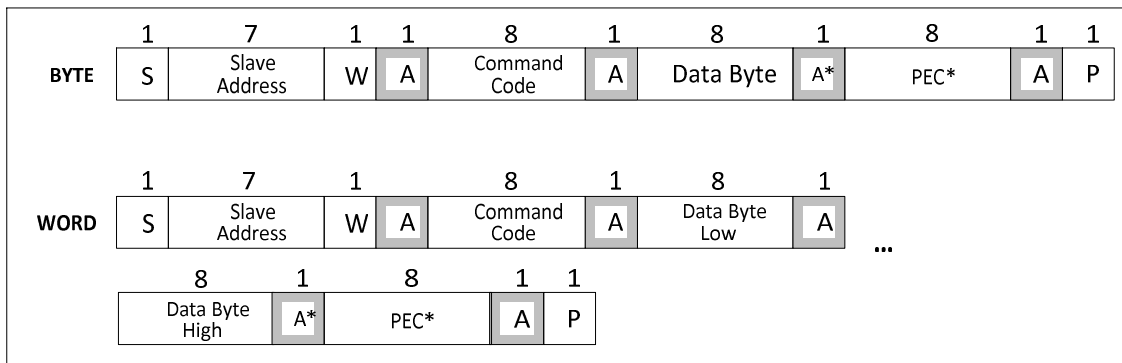

**Figure 54: PMBus Write Byte/Word**

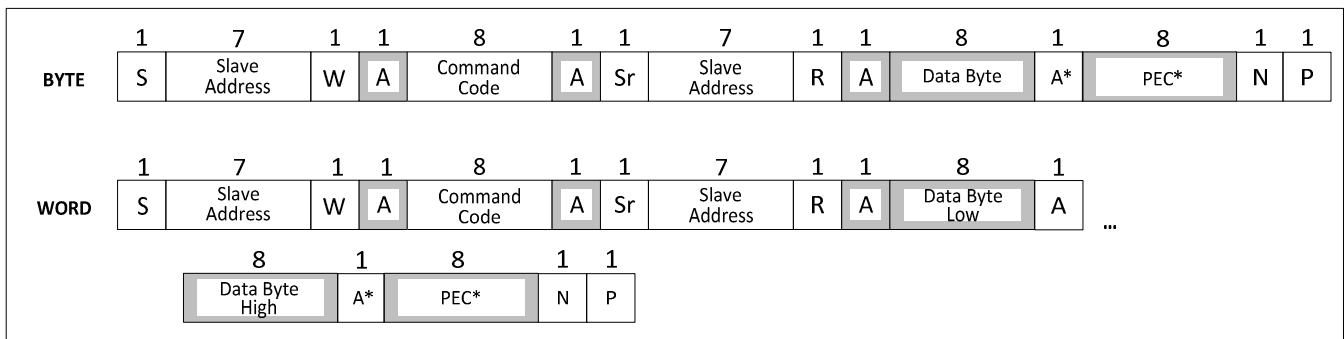

**Figure 55: PMBus Read Byte/Word**



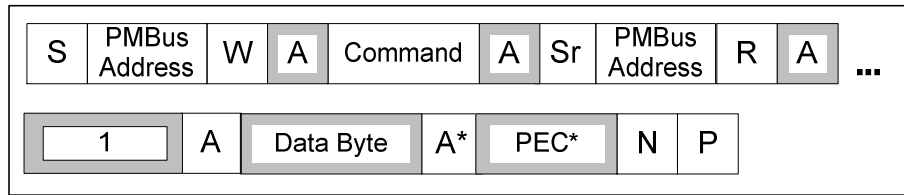

Figure 56: PMBus Block Read with Byte Count=1

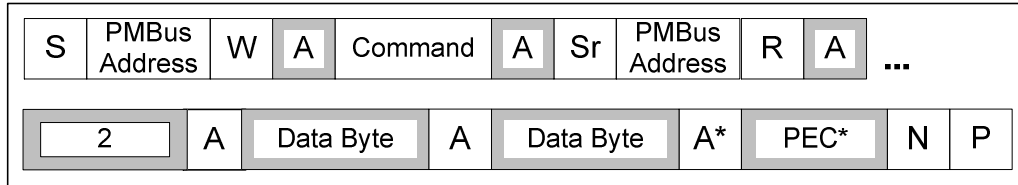

Figure 57: PMBus Block Read with Byte Count=2

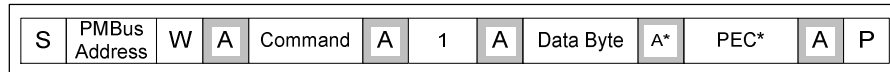

Figure 58: PMBus Block Write with Byte Count=1

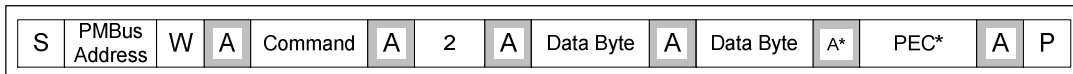

Figure 59: PMBus Block Write with Byte Count=2



Figure 60: MFR\_WRITE\_REG

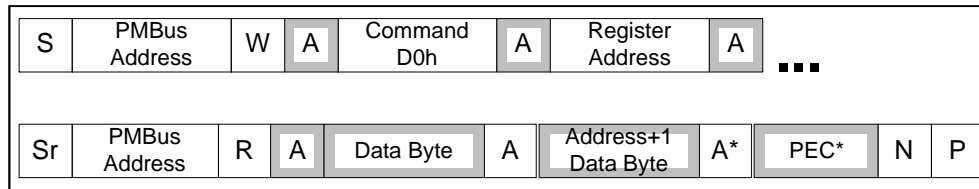

Figure 61: MFR\_READ\_REG

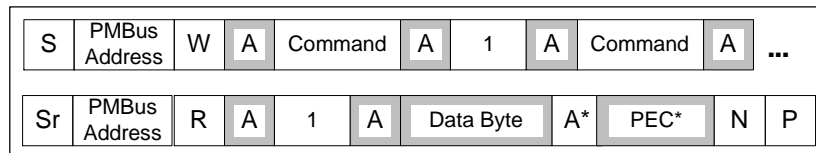

Figure 62: Block Read Process Call

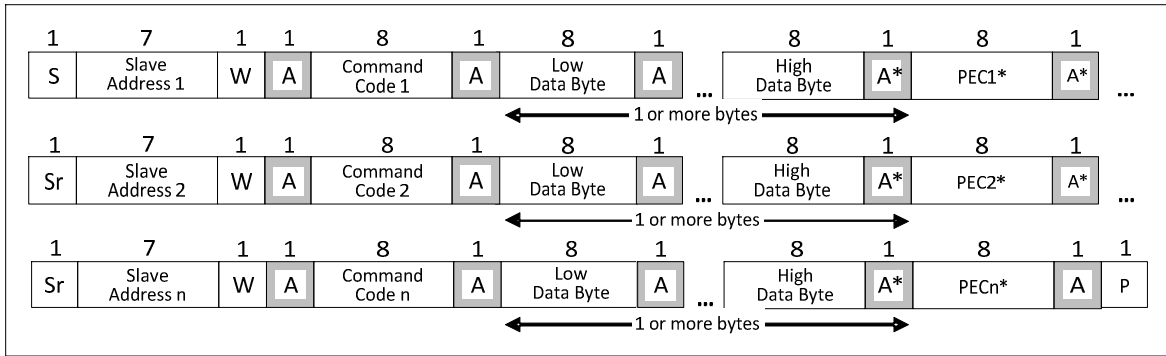

Figure 63: Group Command

TABLE 56: PMBUS COMMANDS

COMMAND	PMBUS PROTOCOL	COMMAND CODE	DESCRIPTION
OPERATION	Read/Write Byte	01h	Enables or disables the output and controls margining. Ignores OVP on Margin High, UVP on Margin Low.
ON_OFF_CONFIG	Read/Write Byte	02h	Configures the combination of CONTROL pin and OPERATION command needed to turn the unit on and off.
CLEAR FAULTS	Send Byte	03h	Clear contents of Fault registers
WRITE_PROTECT	Read/Write Byte	10h	Provides protection from accidental changes
RESTORE_DEFAULT_ALL	Send Byte	12h	Reloads the OTP
CAPABILITY	Read Byte	19h	Returns 1010xxxx to indicate Packet Error Checking is supported and Maximum bus speed is 400kHz
SMBALERT_MASK	Block Write/ Block Read Process Call	1Bh	Set to prevent warning or fault conditions from asserting the SMBALERT# signal. Write command code for STATUS register to be masked in the low byte, the bit to be masked in the High byte.
VOUT_MODE	Read/Write Byte	20h	Sets the format for VOUT related commands. Linear mode, -8 and -9 exponents supported.
VOUT_COMMAND	Read/Write Word	21h	Sets the voltage to which the device should set the output. Format according to VOUT_MODE.
VOUT_TRIM	Read/Write Word	22h	Applies a fixed offset to the output voltage command value. Format according to VOUT_MODE.
VOUT_MAX	Read/Write Word	24h	Sets an upper limit on the output voltage the unit can command. Format according to VOUT_MODE.
VOUT_MARGIN_HIGH	Read/Write Word	25h	Sets the margin high voltage when commanded by OPERATION. Must be in format determined by VOUT_MODE.
VOUT_MARGIN_LOW	Read/Write Word	26h	Sets the margin low voltage when commanded by OPERATION. Must be in format determined by VOUT_MODE.
VOUT_TRANSITION_RATE	Read/Write Word	27h	Sets the rate at which the output changes voltage due to VOUT_COMMAND or OPERATION commands. mV/μs; exp = [0,-1,-2,-3,-4]
VOUT_DROOP	Read/Write Word	28h	Sets the rate at which the output voltage decreases or increases with increasing or decreasing output current for use with Adaptive Voltage Positioning.
VOUT_SCALE_LOOP	Read/Write Word	29h	Sets the gain of the output voltage sensing circuitry to take

COMMAND	PMBUS PROTOCOL	COMMAND CODE	DESCRIPTION
			into account an external resistor divider. Fixed to E8 08h
FREQUENCY_SWITCH	Read/Write Word	33h	Sets the switching frequency in KHz per table found in user note AN00031. Exp = 0, 1
VIN_ON	Read/Write Word	35h	Sets the value of the input voltage at which the unit should begin power conversion. Exp = -1.
VIN_OFF	Read/Write Word	36h	Sets the value of the input voltage that the unit, once operation has started, should stop power conversion. Exp = -1.
INTERLEAVE	Read/Write Word	37h	The INTERLEAVE command is used to arrange multiple units so that their switching periods can be distributed in time. This may be used to facilitate paralleling of multiple units or to reduce ac currents injected into the power bus. Only available on parts with the SYNC function.
IOUT_CAL_OFFSET	Read/Write Word	39h	Used to null out any offsets in the output current sensing circuitry. Exp = -2.
VOUT_OV_FAULT_LIMIT	Read Only	40h	Returns the value of the output voltage, measured at the sense or output pins, that causes an output overvoltage fault.
VOUT_OV_FAULT_RESPONSE	Read/Write Byte	41h	Instructs the device on what action to take in response to an output overvoltage fault. Only shutdown and ignore are supported.
VOUT_OV_WARN_LIMIT	Read/Write Word	42h	Sets the value of the output voltage, measured at the sense or output pins, that causes an output overvoltage warning. Format as determined by VOUT_MODE.
VOUT_UV_WARN_LIMIT	Read/Write Word	43h	Sets the value of the output voltage, measured at the sense or output pins, that causes an output voltage low warning. Format as determined by VOUT_MODE.
VOUT_UV_FAULT_LIMIT	Read Only	44h	Returns the value of the output voltage, measured at the sense or output pins, that causes an output undervoltage fault.
VOUT_UV_FAULT_RESPONSE	Read/Write Byte	45h	Instructs the device on what action to take in response to an output undervoltage fault. Only shutdown and ignore are supported.
IOUT_OC_FAULT_LIMIT	Read/Write Word	46h	Sets the value of the output current, in amperes, that causes the overcurrent detector to indicate an overcurrent fault condition. Set by writing this command in Linear format with a -1 exponent.
IOUT_OC_FAULT_RESPONSE	Read/Write Byte	47h	Instructs the device on what action to take in response to an output overcurrent fault. Only C0h (shutdown immediately), F8h (hiccup forever), and D8 (hiccup 3 times) are supported.
IOUT_OC_WARN_LIMIT	Read/Write Word	4Ah	Sets the value of the output current that causes an output overcurrent warning. Set by writing this command in Linear format with a -1 exponent.
OT_FAULT_LIMIT	Read/Write Word	4Fh	Sets the temperature, in degrees Celsius, of the unit at which it should indicate an overtemperature fault. Exp = 0.
OT_FAULT_RESPONSE	Read/Write Byte	50h	Instructs the device on what action to take in response to an overtemperature fault. Only shutdown and ignore are

COMMAND	PMBUS PROTOCOL	COMMAND CODE	DESCRIPTION
			supported.
OT_WARN_LIMIT	Read/Write Word	51h	Sets the temperature, in degrees Celsius, of the unit at which it should indicate an Overtemperature Warning alarm. Exp = 0.
VIN_OV_FAULT_LIMIT	Read/Write Word	55h	Sets the value of the input voltage that causes an input overvoltage fault. Exp = -4.
VIN_OV_FAULT_RESPONSE	Read/Write Byte	56h	Instructs the device on what action to take in response to an input overvoltage fault. Only shutdown and ignore are supported.
VIN_UV_WARN_LIMIT	Read/Write Word	58h	Sets the value of the input voltage that causes an input voltage low warning. Exp = -4.
IIN_OC_WARN_LIMIT	Read/Write Word	5Dh	Sets the value of the input current, in amperes, that causes a warning that the input current is high. Exp = -1.
POWER_GOOD_ON	Read/Write Word	5Eh	Sets the output voltage at which an optional POWER_GOOD signal should be asserted. Format according to VOUT_MODE.
POWER_GOOD_OFF	Read/Write Word	5Fh	Sets the output voltage at which an optional POWER_GOOD signal should be negated. Format according to VOUT_MODE.
TON_DELAY	Read/Write Word	60h	Sets the time, in milliseconds, from when a start condition is received (as programmed by the ON_OFF_CONFIG command) until the output voltage starts to rise. Exp = 0.
TON_RISE	Read/Write Word	61h	Sets the time, in milliseconds, from when the output starts to rise until the voltage has entered the regulation band. Exp = 0.
TON_MAX_FAULT_LIMIT	Read/Write Word	62h	Sets an upper limit, in milliseconds, on how long the unit can attempt to power up the output without reaching the output undervoltage fault limit. Exp = 0.
TON_MAX_FAULT_RESPONSE	Read/Write Byte	63h	Instructs the device on what action to take in response to a TON_MAX fault. Only shutdown and ignore are supported.
TOFF_DELAY	Read/Write Word	64h	Sets the time, in milliseconds, from when a stop condition is received (as programmed by the ON_OFF_CONFIG command) until the unit stops transferring energy to the output. Exp = 0.
TOFF_FALL	Read/Write Word	65h	Sets the time, in milliseconds, from the end of the turn-off delay time until the voltage is commanded to zero. Exp = 0.
STATUS_BYTE	Read/Write Byte	78h	Returns 1 byte where the bit meanings are: Bit <7> Reserved Bit <6> Output off (due to fault or enable) Bit <5> Output over-voltage fault Bit <4> Output over-current fault Bit <3> Input Under-voltage fault Bit <2> Temperature fault Bit <1> Communication/Memory/Logic fault Bit <0>: Reserved
STATUS_WORD	Read/Write Word	79h	Returns 2 bytes where the Low byte is the same as the STATUS_BYTE data. The High byte has bit meanings are: Bit <7> Output high or low fault Bit <6> Output over-current fault Bit <5> Input under-voltage fault

COMMAND	PMBUS PROTOCOL	COMMAND CODE	DESCRIPTION
			Bit <4> MFR_SPECIFIC Bit <3> POWER_GOOD# Bit <2:0> Reserved
STATUS_VOUT	Read/Write Byte	7Ah	Bit <7> Output Overvoltage Fault Bit <6> Output Overvoltage Warning Bit <5> Output Undervoltage Warning Bit <4> Output Undervoltage Fault Bit <3> VOUT_MAX Warning Bit <2> TON_MAX_FAULT Bit <1> Reserved Bit <0> Reserved
STATUS_IOUT	Read/Write Byte	7Bh	Bit <7> Output Overcurrent Fault Bit <6> Reserved Bit <5> Output Overcurrent Warning Bit <4> Reserved Bit <3> Current Share Fault Bit <2:0> Reserved
STATUS_INPUT	Read/Write Byte	7Ch	Bit <7> Input Overvoltage Fault Bit <6> Reserved Bit <5> Input Undervoltage Warning Bit <4> Input Undervoltage Fault Bit <3> Unit Off For Insufficient Input Voltage Bit <2> Reserved Bit <1> Input Overcurrent Warning Bit <0> Reserved
STATUS_TEMPERATURE	Read/Write Byte	7Dh	Bit <7> Over Temperature Fault Bit <6> Over Temperature Warning Bit <5:0> Reserved
STATUS_CML	Read/Write Byte	7Eh	Returns 1 byte where the bit meanings are: Bit <7> Invalid or unsupported command Bit <6> Invalid or unsupported data Bit <5> PEC fault Bit <4:2> Reserved Bit <1> Other communication fault not listed here Bit <0> Reserved
STATUS_MFR_SPECIFIC	Read/Write Byte	80h	Returns 1 byte where the bit meanings are: Bit <7:4> Reserved Bit <3> Loss of SYNC Bit <2> Driver Fault Bit <1> Unpopulated Phase Bit <0> External Overtemperature Fault
READ_VIN	Read Word	88h	Returns the input voltage in Volts
READ_IIN	Read Word	89h	Returns the input current in Amperes
READ_VOUT	Read Word	8Bh	Returns the output voltage in the format set by VOUT_MODE
READ_IOUT	Read Word	8Ch	Returns the output current in Amperes
READ_TEMPERATURE_1	Read Word	8Dh	Returns the addressed loop NTC temperature in degrees Celsius
READ_TEMPERATURE_2	Read Word	8Eh	Returns the other loop NTC temperature in degrees Celsius
READ_DUTY_CYCLE	Read Word	94h	Returns the duty cycle of the PMBus device's main power converter in percent.

COMMAND	PMBUS PROTOCOL	COMMAND CODE	DESCRIPTION
READ_POUT	Read Word	96h	Returns the output power in Watts
READ_PIN	Read Word	97h	Returns the input power in Watts
PMBUS_REVISION	Read Byte	98h	Reports PMBus Part I rev 1.1 & PMBus Part II rev 1.2(draft)
MFR_ID	Block Read/Write Byte count = 2	99h	The MFR_ID is set to IR (ASCII 52 49) unless programmed different in the USER registers of the controller.
MFR_MODEL	Block Read, byte count = 1	9Ah	The MFR_Model is the same as the device ID if the USER register for Manufacturer model is 00. Otherwise MFR_Model command returns the value in the USER register for MFR_Model.
MFR_REVISION	Block Read, byte count = 2	9Bh	The MFR_Revision is the same as the device revision if the USER register for Manufacturer revision is 00. Otherwise MFR_Revision command returns the value in the USER register for MFR_Revision.
MFR_DATE	Block Read/Write Byte count = 2	9Dh	The MFR_DATE command returns the value in the USER register called MFR_DATE
IC_DEVICE_ID	Block Read	ADh	Returns a 1 byte code with the following values: 50 = IR35204
IC_DEVICE_REV	Block Read	A Eh	The IC revision that is stored inside the IC
MFR_READ_REG	Custom MFR protocol	D0h	Read I2C registers
MFR_WRITE_REG	Write Word	D1h	Write to I2C registers, High Byte is reg, low byte is data

### 11-BIT LINEAR DATA FORMAT

Monitored parameters use the Linear Data Format (Figure 64) encoding into 1 Word (2 bytes), where:

$$Value = Y \times 2^N$$

Note: N and Y are “signed” values.

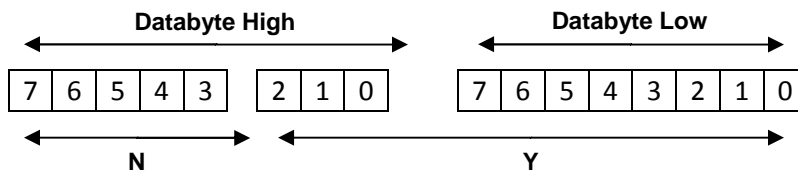

Figure 64: 11-bit Linear Data Format

### 16-BIT LINEAR DATA FORMAT

This format is only used for VOUT related commands (READ\_VOUT, VOUT\_MARGIN\_HIGH, VOUT\_MARGIN\_LOW, VOUT\_COMMAND):

$$Value = Y \times 2^N$$

Note: N is a “signed” value. If VOUT is set to linear format (by VOUT\_MODE), then N is set by the VOUT\_MODE command and only Y is returned in the data-field as a 16-bit unsigned number.

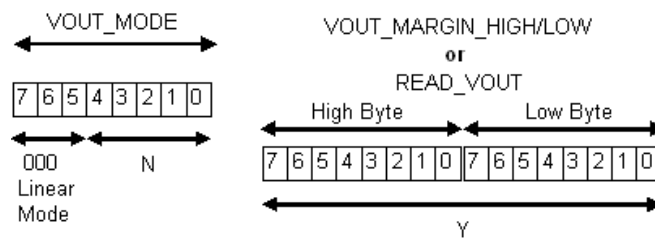

Figure 65: 16-bit Linear Data Format

**SVID REGISTERS**

A list of all the SVID registers is given in Table 57. SVID registers supported by IR35204 in VR12.5 and IMVP8 mode conform to VR12.5 and IMVP8 specifications respectively.

Table 57: SVID Registers

Register Address	Register Name	Access	VR12.5 Mode	IMVP8 Mode
00	Vendor ID	RO	Supported	Supported
01	Product ID	RO	Supported	Supported
02	Product Revision	RO	Supported	Supported
03	Product Date Code	-	Not Supported	Not Supported
04	Lot Code	-	Not Supported	Not Supported
05	Protocol ID	RO	Supported	Supported
06	Capability	RO	Supported	Supported
07	Vendor-Timeout	RW	Supported	Supported
08	Vendor Use	RO	Supported	Supported
09	Vendor Use	-	Not Supported	Not Supported
0A	Vendor Use	-	Not Supported	Not Supported
0B	Vendor Use	-	Not Supported	Not Supported
0C	Vendor Use	-	Not Supported	Not Supported
0D	Vendor Use	RO	Supported, For Factor Use Only	Supported, For Factor Use Only
0E	Vendor Use	RW	Supported, For Factor Use Only	Supported, For Factor Use Only
0F	Vendor Use	RW	Supported, For Factor Use Only	Supported, For Factor Use Only
10	Status_1	RO	Supported	Supported
11	Status_2	RO	Supported	Supported
12	Temperature Zone	RO	Supported	Supported
13	Reserved	-	Not Supported	Not Supported
14	Reserved	-	Not Supported	Not Supported
15	Output Current	RO	Supported	Supported
16	Output Voltage	RO	Supported	Supported
17	VR Temperature	RO	Supported	Supported
18	Output Power	RO	Supported	Supported
19	Input Current	RO	Supported	Supported
1A	Input Voltage	RO	Supported	Supported
1B	Input Power	RO	Supported	Supported
1C	Status 2 Last Read	RO	Supported	Supported
1D	Future Command	-	Not Supported	Not Supported
1E	Future Command	-	Not Supported	Not Supported
1F	Future Command	-	Not Supported	Not Supported
20	Future Command	-	Not Supported	Not Supported
21	ICC Max	RO	Supported	Supported
22	Temp Max	RO	Supported	Supported
23	DC_LL	RO	Supported	Supported
24	SR_Fast	RO	Supported	Supported
25	SR_Slow	RO	Supported	Supported
26	Vboot	RO	Supported	Supported
27	VR Tolerance	-	Not Supported	Not Supported
28	Current-Offset	RO	Supported	Supported
29	Temperature Offset	RO	Supported	Supported
2A	Slow Slew Rate Select	RO	Not Supported	Supported
2B	PS4 Exit Latency	RO	Not Supported	Supported
2C	PS3 Exit Latency	RO	Not Supported	Supported
2D	Enable to Ready	RO	Not Supported	Supported



Register Address	Register Name	Access	VR12.5 Mode	IMVP8 Mode
2E	Pin Max	RO	Not Supported	Supported
2F	Pin Alert Threshold	RW	Not Supported	Supported
30	V <sub>OUT</sub> Max	RW	Supported	Supported
31	VID Setting	RW	Supported	Supported
32	Pwr State	RW	Supported	Supported
33	Offset	RW	Supported	Supported
34	Multi VR Config	RW	Supported	Supported
35	Set RegADR	RW	Supported	Supported
36	Future Command	-	Not Supported	Not Supported
37	Future Command	-	Not Supported	Not Supported
38	Future Command	-	Not Supported	Not Supported
39	Future Command	-	Not Supported	Not Supported
3A	Work Point 0	RW	Not Supported	Not Supported
3B	Work Point 1	RW	Not Supported	Not Supported
3C	Work Point 2	RW	Not Supported	Not Supported
3D	Work Point 3	RW	Not Supported	Not Supported
3E	Work Point 4	RW	Not Supported	Not Supported
3F	Work Point 5	-	Not Supported	Not Supported
40	Work Point 6	-	Not Supported	Not Supported
41	Work Point 7	-	Not Supported	Not Supported
42	I <sub>VID1</sub> -VID	RW	Not Supported	Supported
43	I <sub>VID1</sub> -I	RW	Not Supported	Supported
44	I <sub>VID2</sub> -VID	RW	Not Supported	Supported
45	I <sub>VID2</sub> -I	RW	Not Supported	Supported
46	I <sub>VID3</sub> -VID	RW	Not Supported	Supported
47	I <sub>VID3</sub> -I	RW	Not Supported	Supported

## MARKING INFORMATION

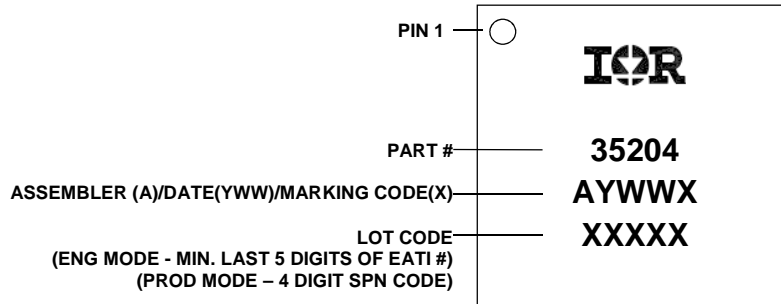

Figure 66: Package Marking

## PACKAGE INFORMATION

QFN 5x5mm, 40-pin

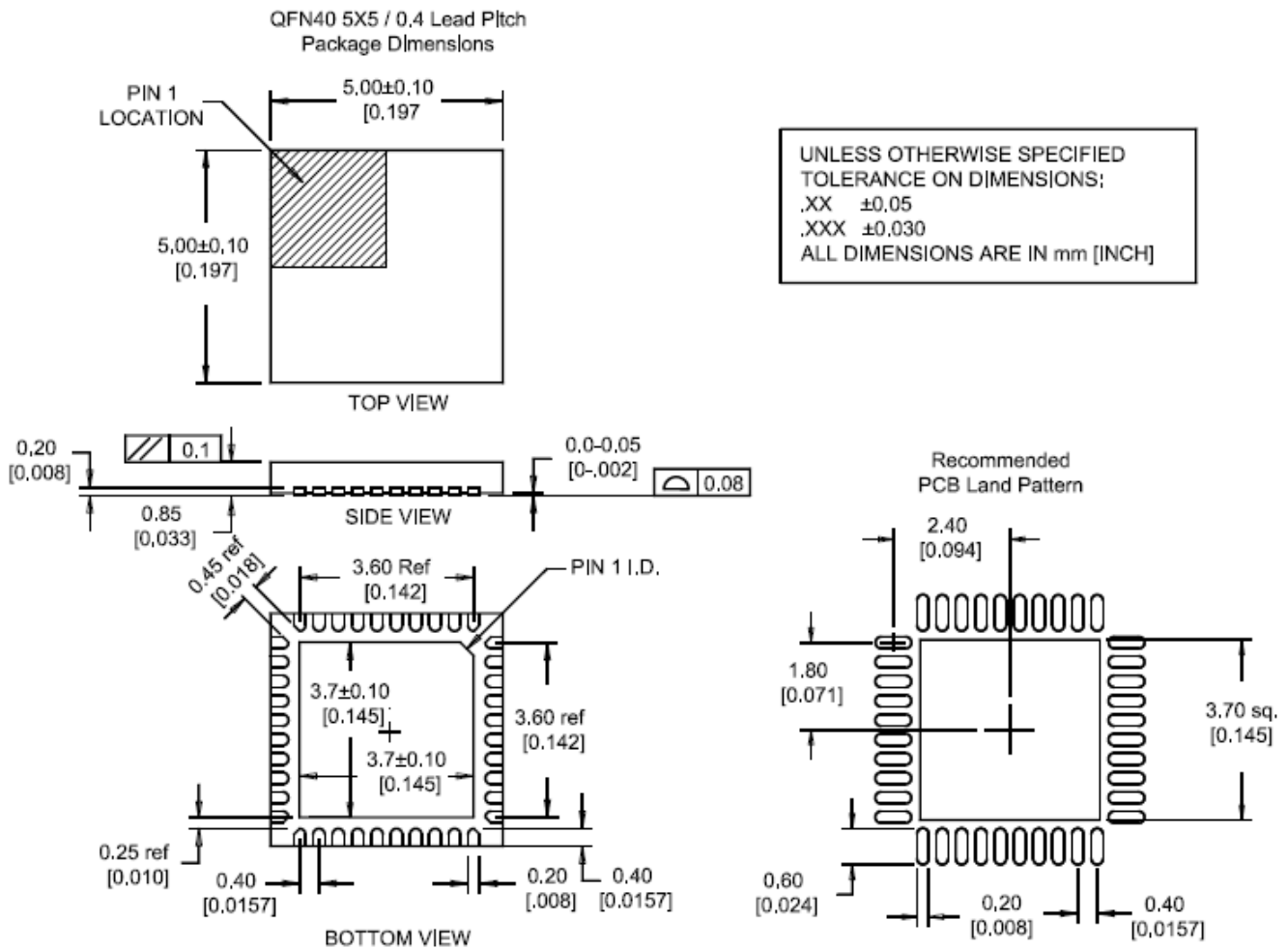

Figure 67: Package Dimensions

## ENVIRONMENTAL QUALIFICATIONS

<b>Qualification Level</b>		Industrial	
<b>Moisture Sensitivity Level</b>		QFN package	MSL2
<b>ESD</b>	<b>Machine Model</b>	JESD22-A115-A	
	<b>Human Body Model</b>	JESD22-A114-E	
	<b>Charged Device Model</b>	JESD22-C101-C	
	<b>Latch-up</b>	JESD78	
<b>RoHS Compliant</b>		Yes	

† Qualification standards can be found at International Rectifier web site: <http://www.irf.com>

†† Exceptions to AEC-Q101 requirements are noted in the qualification report.

Data and specifications subject to change without notice.  
This product will be designed and qualified for the Industrial market.  
Qualification Standards can be found on IR's Web site.

International  
**IR** Rectifier

**IR WORLD HEADQUARTERS:** 233 Kansas St., El Segundo, California 90245, USA Tel: (310) 252-7105

TAC Fax: (310) 252-7903

Visit us at [www.irf.com](http://www.irf.com) for sales contact information.

[www.irf.com](http://www.irf.com)

# Mouser Electronics

Authorized Distributor

Click to View Pricing, Inventory, Delivery & Lifecycle Information:

[Infineon:](#)

[IR35204MTRPBF](#)