



Wideband Transconductance Amplifiers

MAX435/MAX436

General Description

The MAX435 and MAX436 are high-speed, wideband transconductance amplifiers (WTAs) with true differential, high-impedance inputs. Their unique architecture provides accurate gain without negative feedback, eliminating closed-loop phase shift — a primary cause of circuit oscillation in conventional high-speed amplifiers. The output of the WTA is a current that is proportional to the applied differential input voltage, providing inherent short-circuit protection for the outputs. Circuit gain is set by the ratio of two impedances and an internally set current gain factor (K).

The current output and the absence of negative feedback allow the differential output MAX435 to achieve a bandwidth of 275MHz, an 800V/ μ s slew rate, and a 1% settling time of 18ns to a 0.5V step input. The single-ended output MAX436 achieves a bandwidth of 200MHz, an 850V/ μ s slew rate, and a 1% settling time of 18ns to a 0.5V step input. Both amplifiers offer exceptional wideband common-mode rejection, with a CMRR of 53dB at 10MHz. 300 μ V input offset voltage offers a level of DC precision rarely found in high-speed op amps.

Unlike current-feedback amplifiers, the MAX435/MAX436 have fully symmetrical, high-impedance inputs that tolerate wide differential input voltages without destructive failure or amplifier saturation, virtually eliminating overload recovery time. The unique performance features of these WTAs suit them for a wide variety of applications, such as high-speed instrumentation amplifiers and wideband, high-gain bandpass amplifiers. And, with its differential output, the MAX435 can be used in high-speed differential line driver and receiver applications.

Applications

- High-Speed Instrumentation Amplifiers
- High-Speed Filters
- Wideband, High-Gain Bandpass Amplifiers
- Differential Line Receivers
- Differential Line Drivers

Features

- ◆ 275MHz Bandwidth (MAX435)
- ◆ 850V/ μ s Slew Rate
- ◆ 18ns Settling Time to 1%
- ◆ 53dB CMRR at 10MHz
- ◆ Low Noise, 7nV/ $\sqrt{\text{Hz}}$ at 1kHz
- ◆ No Feedback
- ◆ True Differential High-Impedance Inputs
- ◆ Shutdown Capability: 450 μ A (MAX435)

Ordering Information

PART	TEMP. RANGE	PIN-PACKAGE
MAX435CPD	0°C to +70°C	14 Plastic DIP
MAX435CSD	0°C to +70°C	14 SO
MAX435C/D	0°C to +70°C	Dice*
MAX435EPD	-40°C to +85°C	14 Plastic DIP
MAX435ESD	-40°C to +85°C	14 SO
MAX435MJD	-55°C to +125°C	14 CERDIP

Ordering Information continued on last page.
* Dice are specified at $T_A = +25^\circ\text{C}$, DC parameters only.

Pin Configurations

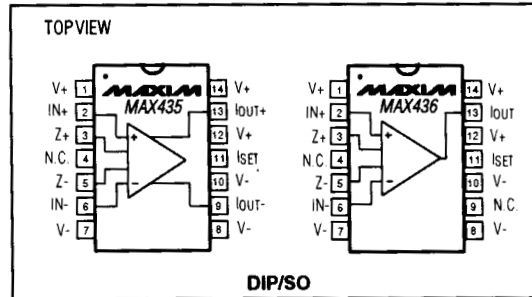

Typical Operating Circuits

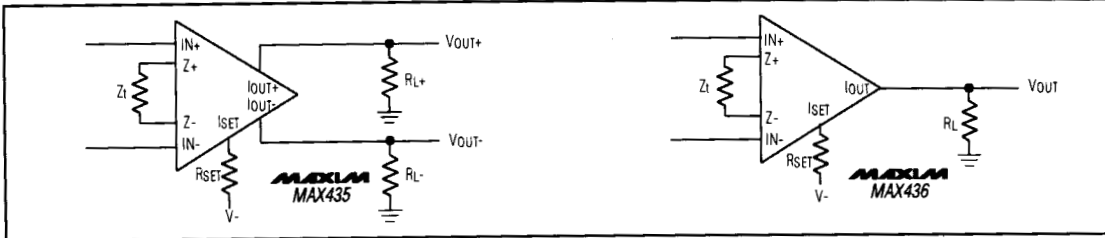

Maxim Integrated Products 1

For free samples & the latest literature: <http://www.maxim-ic.com>, or phone 1-800-998-8800

Wideband Transconductance Amplifiers

ABSOLUTE MAXIMUM RATINGS

Total Supply Voltage (V+ to V-)	12V	SQ (derate 8.33mW/°C above +70°C)	667mW
Positive Supply Voltage (V+ to GND)	6.0V	CERDIP (derate 9.09mW/°C above +70°C)	727mW
Negative Supply Voltage (V- to GND)	-6.0V	Operating Temperature Ranges:	
Input Voltage	(V- - 0.3V) to (V+ + 0.3V)	MAX43_C	0°C to +70°C
Current Limit through Z+ or Z-	10mA	MAX43_E	-40°C to +85°C
Output Short-Circuit Duration	Continuous	MAX43_MJD	-55°C to +125°C
ISET Short-Circuit Duration (to GND or VEE)	1 sec	Storage Temperature Range	-65°C to +160°C
Continuous Power Dissipation (TA = +70°C)		Lead Temperature (soldering, 10 sec)	+300°C
Plastic DIP (derate 10.00mW/°C above +70°C)	800mW		

Stresses beyond those listed under "Absolute Maximum Ratings" may cause permanent damage to the device. These are stress ratings only, and functional operation of the device at these or any other conditions beyond those indicated in the operational sections of the specifications is not implied. Exposure to absolute maximum rating conditions for extended periods may affect device reliability.

ELECTRICAL CHARACTERISTICS – MAX435

(V+ = 5V, V- = -5V, -2.5V ≤ IN+ ≤ 2.5V, -2.5V ≤ IN- ≤ 2.5V, ZL+ = ZL- = 50Ω, ZI = 400Ω, RSET = 5.9kΩ, TA = +25°C, Tj = +25°C, unless otherwise noted. Specification is at +25°C junction temperature due to requirements of high-speed automatic testing. Actual values at operating temperatures may exceed the value at Tj = +25°C. No-load operating junction temperature may rise 30°C to 50°C above ambient.)

PARAMETER	SYMBOL	CONDITIONS	MIN	TYP	MAX	UNITS
Operating Supply Voltage	V+, V-	-55°C to +125°C	±4.75	±5.00	±5.25	V
Supply Current	IS	-55°C to +125°C	30	35	41	mA
Input Voltage Range	IN+, IN-	-55°C to +125°C	-2.5		2.5	V
Input Offset Voltage	VOS			0.3	3.0	mV
Input Offset-Voltage Drift	ΔVOS/ΔT			3.5		μV/°C
Input Bias Current	IB	TA = +25°C		1.0	3.0	μA
		0°C to +70°C			5	
		-40°C to +85°C			10	
		-55°C to +125°C			10	
Input Resistance	RIN		200	800		kΩ
DC Resistance Looking into Z+ or Z-	RZ			0.15	1.50	Ω
Output Voltage Range	VOUT+, VOUT-	ZL+ = ZL- = 500Ω	-3.5		3.5	V
Output Impedance	ROUT		2.0	3.5		kΩ
Output Current	IOUT		-10		10	mA
Differential Output Offset Current	Ios, DIFF	Z+ and Z- are open, inputs are grounded	-140	0	140	μA
Output Offset Current (either side)	Ios	Z+ and Z- are open, inputs are grounded	-100	-20	100	μA
Output Offset-Current Drift (either side)	ΔIos/ΔT	Z+ and Z- are open, inputs are grounded		2.3		μA/°C
Current Gain Ratio	K	TA = +25°C	3.90	4.00	4.10	A/A
		0°C to +70°C	3.80		4.15	
		-40°C to +85°C	3.70		4.15	
		-55°C to +125°C	3.60		4.20	
Common-Mode Rejection Ratio	CMRR	At DC	70	90		dB
		At 10MHz, ZI = 200Ω, ZL+ = ZL- = 25Ω		53		
Power-Supply Rejection Ratio	PSRR	At DC	50	77		dB
Settling Time to 1%	ts	ZI = 200Ω, ZL+ = ZL- = 25Ω		18		ns
Slew Rate	SR	ZI shorted		800		V/μs
		ZI shorted, ZL+ = ZL- = 25Ω		550		
-3dB Bandwidth	BW	ZI = 200Ω, ZL+ = ZL- = 25Ω		275		MHz
Input Noise-Voltage Density	en	At 1kHz, single-ended input, ZI = 50Ω		7.0		nV/√Hz

Wideband Transconductance Amplifiers

MAX435/MAX436

ELECTRICAL CHARACTERISTICS – MAX436

($V_+ = 5V$, $V_- = -5V$, $-2.5V \leq IN_+ \leq 2.5V$, $-2.5V \leq IN_- \leq 2.5V$, $Z_{L+} = 50\Omega$, $Z_t = 400\Omega$, $R_{SET} = 5.9k\Omega$, $T_A = +25^\circ C$, $T_j = +25^\circ C$, unless otherwise noted. Specification is at $+25^\circ C$ junction temperature due to requirements of high-speed automatic testing. Actual values at operating temperatures may exceed the value at $T_j = +25^\circ C$. No-load operating junction temperature may rise $30^\circ C$ to $50^\circ C$ above ambient.)

PARAMETER	SYMBOL	CONDITIONS	MIN	TYP	MAX	UNITS
Operating Supply Voltage	V_+ , V_-	$-55^\circ C$ to $+125^\circ C$	± 4.75	± 5.00	± 5.25	V
Supply Current	I_S	$-55^\circ C$ to $+125^\circ C$	30	35	41	mA
Input Voltage Range	IN_+ , IN_-	$-55^\circ C$ to $+125^\circ C$	-2.5		2.5	V
Input Offset Voltage	V_{OS}			0.3	3.0	mV
Input Offset-Voltage Drift	$\Delta V_{OS}/\Delta T$			3.5		$\mu V/^\circ C$
Input Bias Current	I_B	$T_A = +25^\circ C$		1.0	3.0	μA
		$0^\circ C$ to $+70^\circ C$			5	
		$-40^\circ C$ to $+85^\circ C$			10	
		$-55^\circ C$ to $+125^\circ C$			10	
Input Resistance	R_{IN}		200	700		$k\Omega$
DC Resistance Looking into Z_+ or Z_-	R_Z			0.15	1.50	Ω
Output Voltage Range	V_{OUT+} , V_{OUT-}	$Z_{L+} = 500\Omega$	-3.5		3.5	V
Output Impedance	R_{OUT}		2.0	3.3		$k\Omega$
Output Current	I_{OUT}		-20		20	mA
Output Offset Current	I_{OS}	Z_+ and Z_- are open, inputs are grounded.	-100	6	100	μA
Output Offset-Current Drift	$\Delta I_{OS}/\Delta T$	Z_+ and Z_- are open, inputs are grounded.		0.75		$\mu A/^\circ C$
Current Gain Ratio	K	$T_A = +25^\circ C$	7.8	8.0	8.2	A/A
		$0^\circ C$ to $+70^\circ C$	7.7		8.3	
		$-40^\circ C$ to $+85^\circ C$	7.6		8.3	
		$-55^\circ C$ to $+125^\circ C$	7.4		8.4	
Common-Mode Rejection Ratio	CMRR	At DC	70	84		dB
		At 10MHz, $Z_t = 200\Omega$, $Z_{L+} = 25\Omega$			53	
Power-Supply Rejection Ratio	PSRR	At DC	40	50		dB
Settling Time to 1%	t_s	$Z_t = 200\Omega$, $Z_{L+} = 25\Omega$		18		ns
Slew Rate	SR	Z_t shorted		850		V/ μs
		Z_t shorted, $Z_{L+} = Z_{L-} = 25\Omega$		450		
-3dB Bandwidth	BW	$Z_t = 200\Omega$, $Z_{L+} = 25\Omega$		200		MHz
Input Noise-Voltage Density	e_n	At 1kHz, single-ended input, $Z_t = 50\Omega$		7.0		nV/ \sqrt{Hz}

Wideband Transconductance Amplifiers

MAX435/MAX436

Typical Operating Characteristics

MAX435

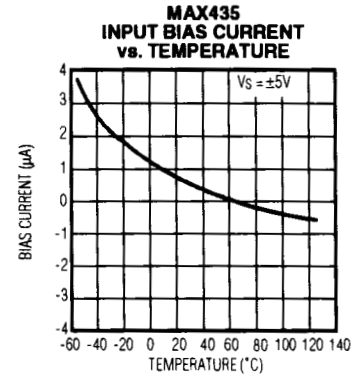
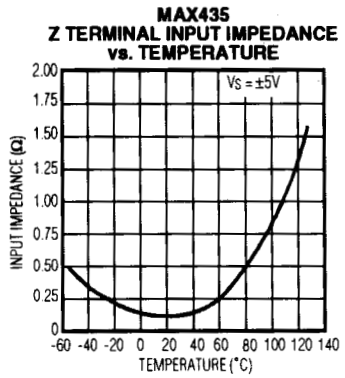
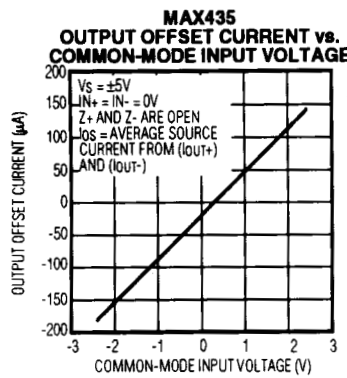
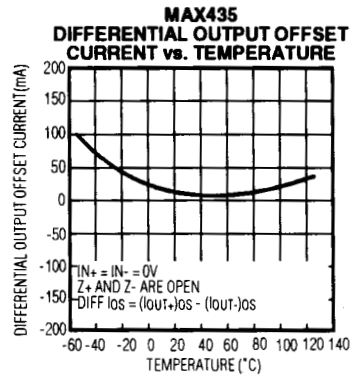
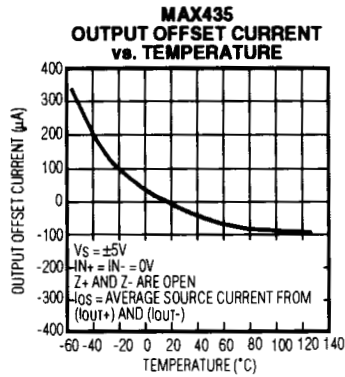
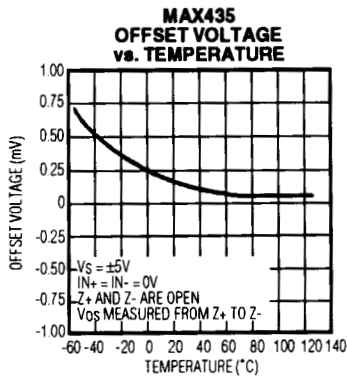
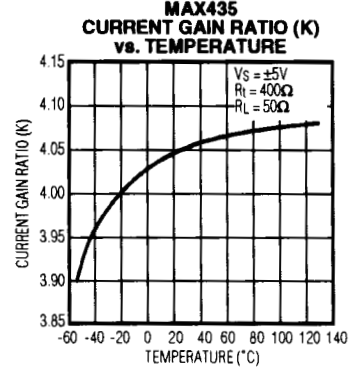
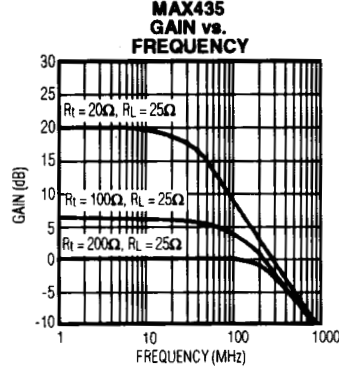
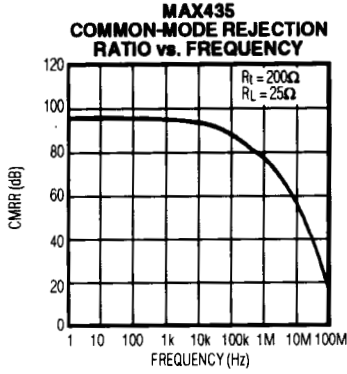

Wideband Transconductance Amplifiers

Typical Operating Characteristics (continued)

MAX435/MAX436

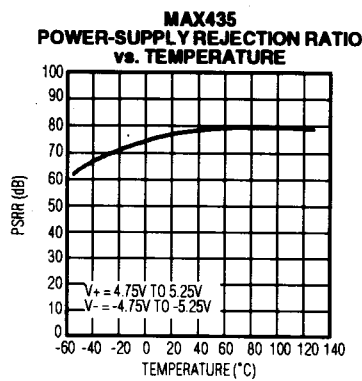
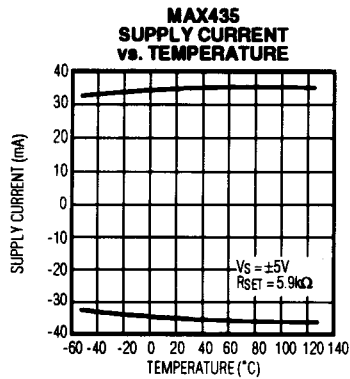
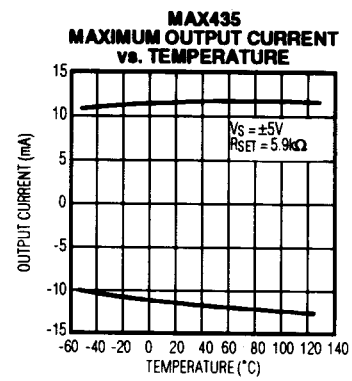
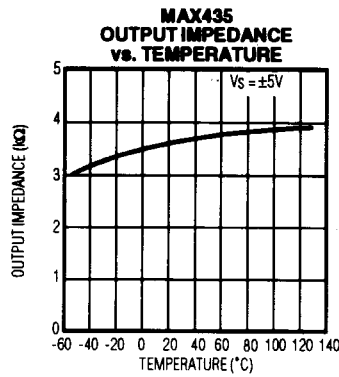
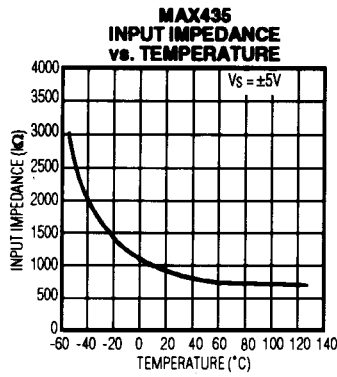

Wideband Transconductance Amplifiers

Typical Operating Characteristics (continued)

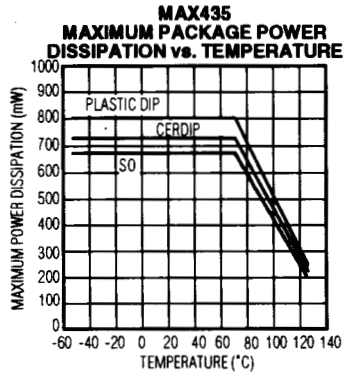
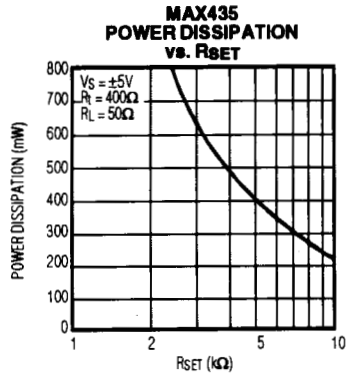
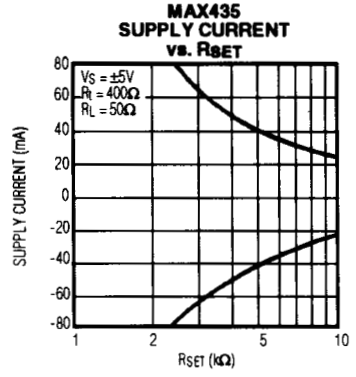
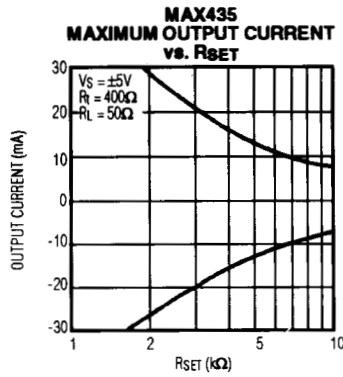
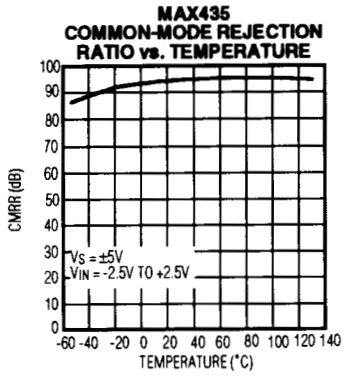

Wideband Transconductance Amplifiers

Typical Operating Characteristics (continued)

MAX435/MAX436

MAX436

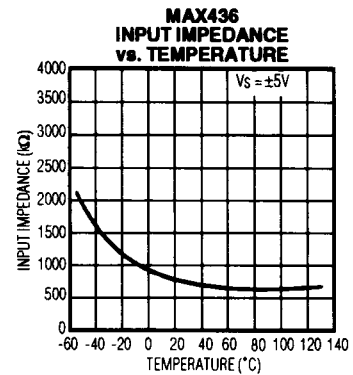
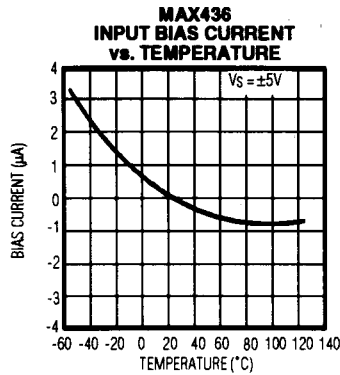
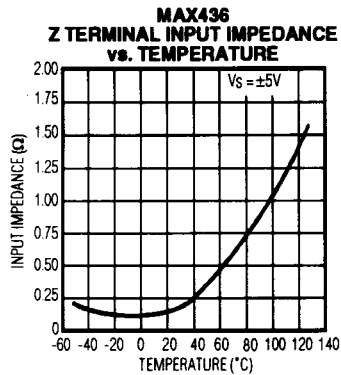
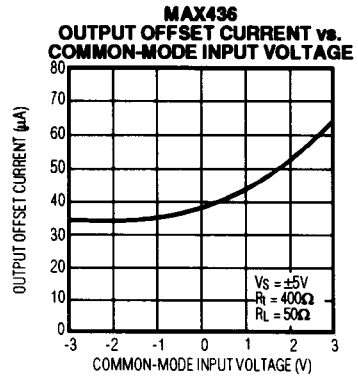
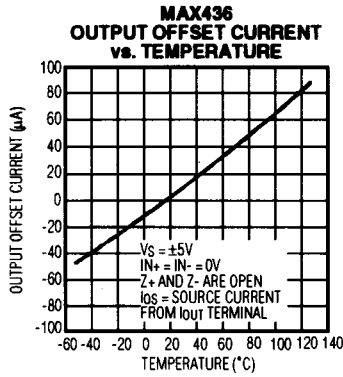
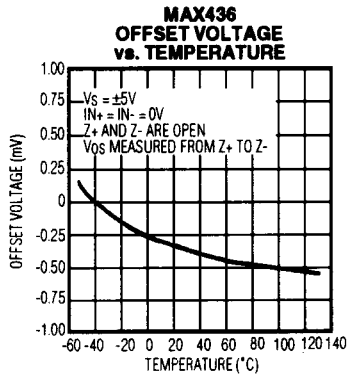
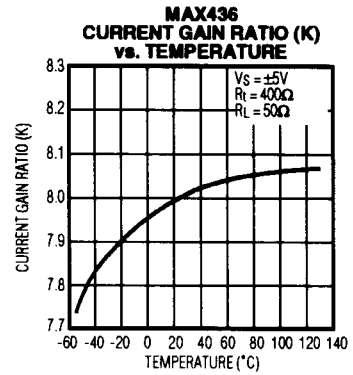
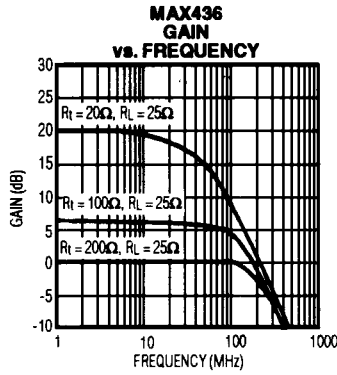
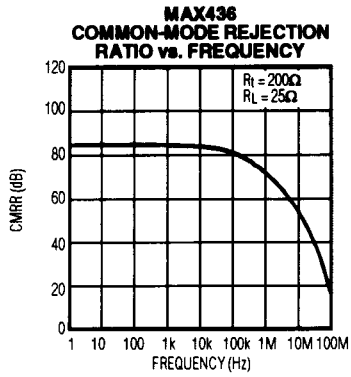

Wideband Transconductance Amplifiers

Typical Operating Characteristics (continued)

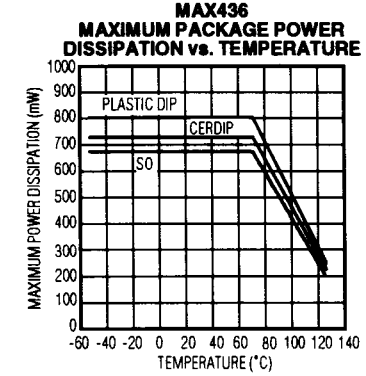
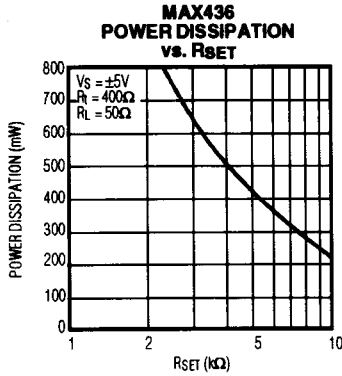
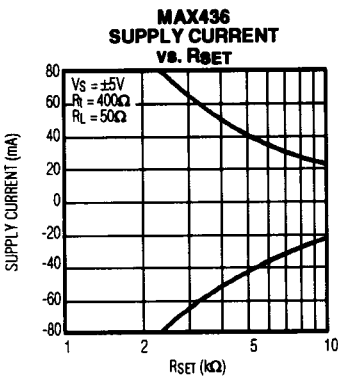
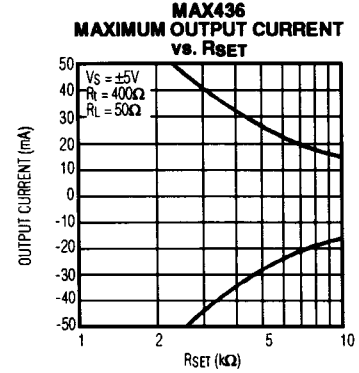
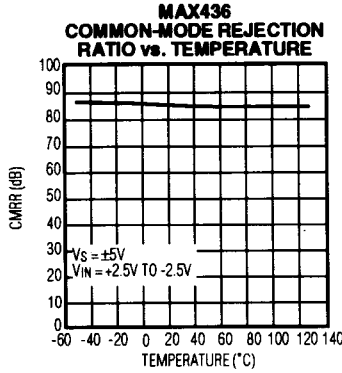
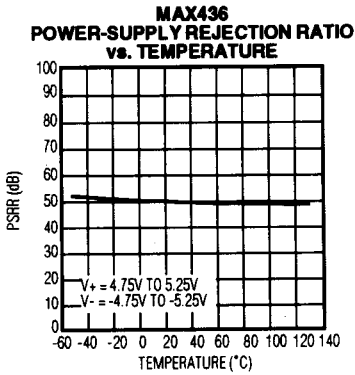
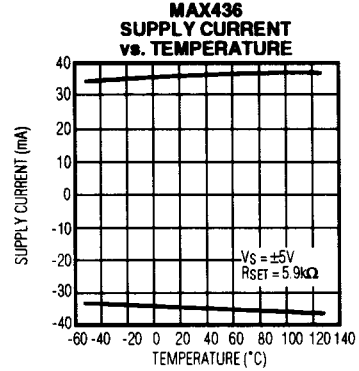
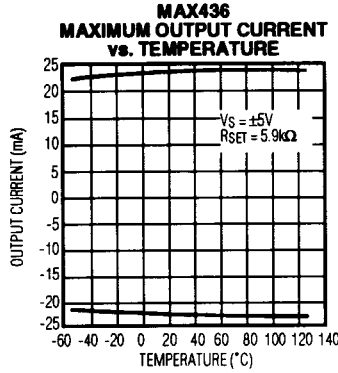
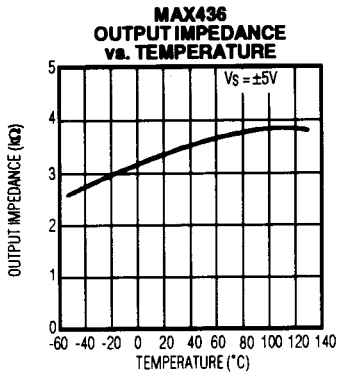

Wideband Transconductance Amplifiers

Pin Description

PIN		NAME	FUNCTION
MAX435	MAX436		
1, 12, 14	1, 12, 14	V+	Positive Power Supply (+5V)
2	2	IN+	Noninverting Amplifier Input
3	3	Z+	Positive Transconductance Terminal
4	4, 9	N.C.	No Connect - Leave this pin open
5	5	Z-	Negative Transconductance Terminal
6	6	IN-	Inverting Amplifier Input Terminal
7, 8, 10	7, 8, 10	V-	Negative Power Supply (-5V)
9	-	IOUT-	Inverting Differential Output
11	11	ISET	Supply-Current Set Terminal
13	-	IOUT+	Noninverting Differential Output
-	13	IOUT	Amplifier Output Terminal

Theory of Operation

The MAX435/MAX436 are wideband transconductance amplifiers (WTA) that operate with no feedback. These amplifiers are intrinsically stable since closed-loop phase shift does not affect amplifier stability. Unlike conventional voltage-mode amplifiers, WTAs need no compensation from an internally set dominant pole. Voltage-mode amplifiers require this pole to roll off open-loop gain and prevent oscillation from high-frequency phase shift.

The MAX435/MAX436's unique architecture allows single-ended (MAX436) or differential (MAX435) signal gain to be set by the ratio of two impedances: the user-selected transconductance element or network (Z_t), and the output load impedance (Z_L). The WTAs are essentially voltage-controlled current sources, as shown in Figure 1.

The MAX435/MAX436's output is a current proportional to the differential input voltage, and inversely proportional to the impedance of the user-selected transconductance element or network (Z_t). The current output provides inherent short-circuit protection for the output terminals.

A differential input voltage (V_{IN}) applied between the input terminals causes current to flow in the transconductance element (Z_t). This current is equal to V_{IN}/Z_t . The current in the transconductance element is multiplied by the preset current gain (K) of the WTA, and appears at the output terminal(s) as a current equal to $(K) \times (V_{IN})/Z_t$. This current flows through the load impedance to produce an output voltage according to the following equation:

$$V_{OUT} = K \left(\frac{Z_L}{Z_t} \right) V_{IN}$$

Where: K = WTA Current-Gain Ratio
 Z_L = Output Load Impedance
 Z_t = Transconductance Element Impedance
 V_{IN} = Differential Input Voltage

Unlike current-feedback amplifiers, the MAX435/MAX436 have symmetrical inputs with an input impedance of about 750k Ω . This allows true differential input applications to be realized, as shown in the MAX435 *Typical Operating Circuit*. And, because the input is symmetrical, opposite signal polarity can be obtained by swapping the input terminals.

With proper selection of component values, it is possible to implement an amplifier circuit that accepts differential input voltages covering the WTA's entire input voltage range (-2.5V to +2.5V), without overloading its output stage. This characteristic makes the MAX435/MAX436 ideal for use in wideband instrumentation amplifiers, differential receivers, and settling-time measurement circuits.

Design Procedure

Setting the Circuit Gain

The MAX435/MAX436 produce an output current by multiplying a differential input voltage, V_{IN} , by the transconductance, K/Z_t . The voltage gain (A_v) is set by the impedance of the transconductance network (Z_t) and the output load impedance (Z_L), according to the following formula:

$$A_v = K \left(\frac{Z_L}{Z_t} \right)$$

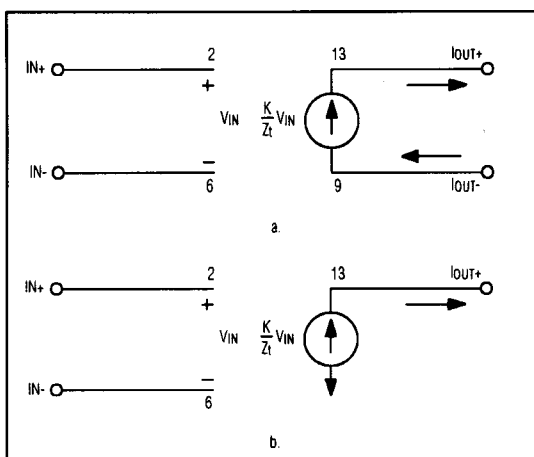

Figure 1. a) MAX435 Operational Model. b) MAX436 Operational Model.

Wideband Transconductance Amplifiers

The factor K in the gain equation refers to the WTA's current gain. K is factory trimmed to provide a low-drift, stable circuit gain for WTA applications. K is trimmed to $4.0 \pm 2.5\%$ for the MAX435, to $8.0 \pm 2.5\%$ for the MAX436.

The factor Z_t in the gain equation is the impedance of a user-selected, 2-terminal transconductance element or network. This network is connected across the WTA's transconductance terminals, labeled as Z_+ and Z_- . The transconductance network should be selected, along with the output impedance, to provide the desired circuit gain and frequency shaping. To maintain linearity, the transconductance network should also be selected so that the current flowing through it, equal to V_{IN}/Z_t , does not exceed 2.5mA under worst-case conditions of maximum input voltage and minimum transconductance element impedance (Z_t). Output current should not exceed $\pm 10\text{mA}$ per output for the MAX435, or $\pm 20\text{mA}$ for the MAX436.

Supply Current (ISET) Control

An external current source controls the WTA's internal current. Connecting an external resistor (R_{SET}) from the ISET pin to the negative power supply (V_-) controls the current source. The typical value for this resistor is $5.9\text{k}\Omega$, which provides an output-current drive capability of $\pm 10\text{mA}$ per output for the MAX435, $\pm 20\text{mA}$ for the MAX436. Connect a $0.22\mu\text{F}$ ceramic capacitor from the ISET pin to V_+ , to decouple the current source.

A larger resistor value will reduce the devices' supply current, power dissipation, and output-current drive capability. A smaller resistor value may also be used to increase the output-current capability, but take care that the power dissipation rating for the device package type is not exceeded for the specific circuit operating conditions. It is especially important to consider the maximum load current and ambient operating temperature of the circuit. Refer to the graphs in the *Typical Operating Characteristics* section for typical values of load current and power dissipation for different values of R_{SET} .

Shutdown Mode

The WTA supply current varies with the value of R_{SET} , but it is relatively independent of the differential input voltage and the output load. The WTAs achieve much of their high-speed performance by maintaining a constant level of current within the internal transistors, and steering some of this current to the output when a differential input voltage is applied. To reduce power dissipation when the output load does not need to be actively driven, the ISET pin can be used to place the

WTA into a low-power shutdown mode. If the ISET pin is disconnected from the R_{SET} resistor and left open, the supply current of the MAX435 is reduced to approximately $450\mu\text{A}$, while the supply current of the MAX436 is reduced to approximately $850\mu\text{A}$. To reactivate the WTA, simply reconnect the ISET pin to the R_{SET} resistor.

PIN	RSET	Supply Current (μA Typ, $+25^\circ\text{C}$)	
		MAX435	MAX436
ISET (11)	Open (00)	450	850

DC Accuracy

The DC accuracy of circuits implemented with the MAX435/MAX436 is affected by several parameters, including:

- 1) Input Offset Voltage
- 2) Output Offset Current
- 3) Accuracy of WTA Current Gain Factor (K)
- 4) Tolerance of External Transconductance and Load Impedances

The input offset voltage of the WTA is caused by a mismatch of V_{BE} voltages between the transistors in the amplifier input stage - the same mechanism that produces input offset voltages in ordinary bipolar amplifiers. The input offset voltage is measured as the voltage between the transconductance terminals (from Z_+ to Z_-), with each of the inputs (IN_+ and IN_-) grounded and no transconductance element in the circuit (Z_+ and Z_- are open).

In an actual application circuit, the input offset voltage causes a current to flow in the transconductance element when no differential voltage is applied at the input terminals. This current is then multiplied by K to produce an error current at the output terminal(s).

A second source of DC error is the output offset current. This parameter is measured with no transconductance element in the circuit (Z_+ and Z_- are open) and the input terminals (IN_+ and IN_-) grounded. Output offset current is the current that flows from an output terminal of the WTA under these conditions. The output offset current is the result of imperfect matching of devices in the output current mirror(s) of the WTA. The output current caused by the input offset voltage, as discussed previously, is NOT included in the Output Offset Current specification, since that component of the total output current will vary with the value of the transconductance element.

Wideband Transconductance Amplifiers

MAX435/MAX436

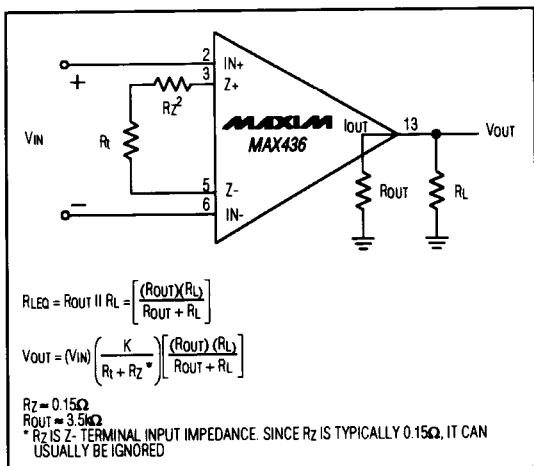

Figure 2. Finite Output-Impedance of WTA

The total DC output voltage error (at each output for the MAX435) due to the input offset voltage and output offset current is calculated with the following formulas:

MAX435:

$$V_{ERR+} = (R_L+) \left[(I_{OS+}) + (K) \left(\frac{V_{OS}}{R_t} \right) \right]$$

$$V_{ERR-} = (R_L-) \left[(I_{OS-}) - (K) \left(\frac{V_{OS}}{R_t} \right) \right]$$

$$V_{ERR(DIFF)} = (V_{ERR+}) - (V_{ERR-})$$

MAX436:

$$V_{ERR} = R_L \left(I_{OS} + K \frac{V_{OS}}{R_t} \right)$$

Where: V_{ERR} = Output-Voltage Error

R_L = Output Load Resistance

R_t = Transconductance Element Resistance

I_{OS} = Output Offset Current

V_{OS} = Input Offset Voltage (from Z+ to Z-)

K = WTA Current Gain

Variation of the current gain factor (K) between devices and over operating temperature is also a source of gain error in WTA applications. K for each of the devices is factory trimmed to an initial tolerance of $\pm 2.5\%$. The variation of K with operating temperature is listed in the *Electrical Characteristics* tables.

The finite output impedance also affects the amplifier gain. The output(s) are voltage-controlled current sources. An ideal current source would have an infinite output impedance, so that the output current would be independent of the load impedance. In practice, the MAX435/MAX436's output impedance is about $3.5k\Omega$.

As shown in Figure 2, the WTA output impedance (R_{OUT}) is paralleled with the circuit load impedance (R_L), reducing the equivalent load impedance. After accounting for the finite WTA output impedance (R_{OUT}), the actual circuit gain is calculated with the following formula:

$$A_V = \frac{V_{OUT}}{V_{IN}} = \left(\frac{K}{R_t} \right) \left[\frac{(R_{OUT})(R_L)}{R_{OUT} + R_L} \right]$$

The voltage gain error (ΔA_V) with respect to the theoretical gain ($A_V = K \times R_L/R_t$) is equal to:

$$\frac{\Delta A_V}{A_V} = \frac{R_L}{R_L + R_{OUT}}$$

Power-Supply Bypassing and Board Layout

Although the WTA architecture eliminates closed-loop phase shift as a source of circuit oscillation, careful high-frequency circuit design methods should be used to optimize the performance of WTA circuits.

Proper power-supply bypassing and board layout deserve careful attention. It is recommended that a ground plane be used with the MAX435/MAX436. The ground plane should include the entire portion of the PC board that is not dedicated to a specific signal trace.

Sockets are not recommended with the WTAs, because the additional pin-to-pin capacitance they introduce degrades wideband performance. Keep the length of traces connecting to the WTA input terminals as short as possible to minimize signal reflections and/or inductive coupling of high-frequency signals to the WTA. If the input signals must travel more than a few inches, use controlled impedance lines or coaxial cables; all signals should be properly terminated. Minimize the PCB pad

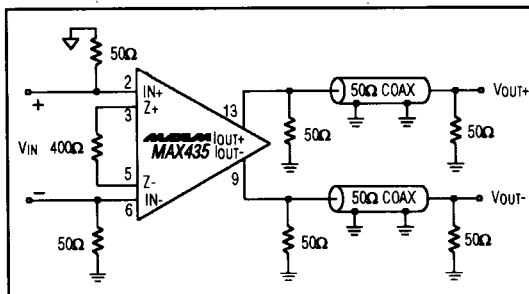

Figure 3. MAX435 Coaxial Cable Driving Circuit

Wideband Transconductance Amplifiers

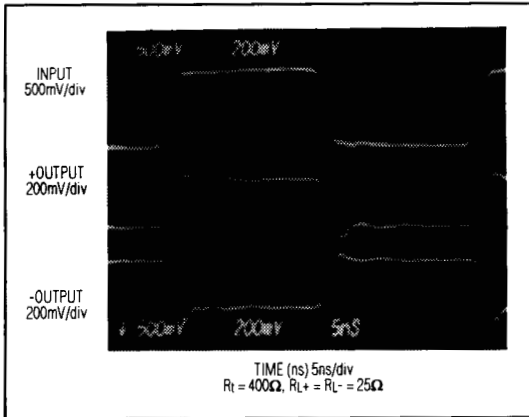

Figure 4. MAX435 Pulse Response

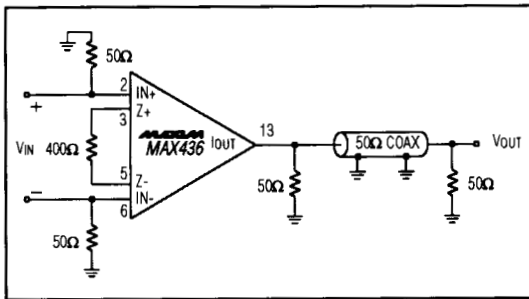

Figure 5. MAX436 Coaxial Cable Driving Circuit

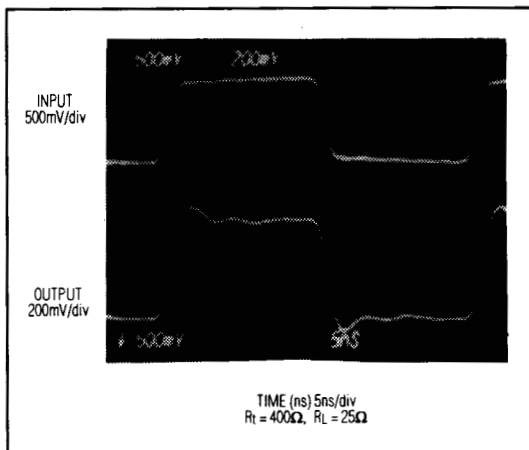

Figure 6. MAX436 Pulse Response

area for input connections, to prevent capacitive coupling of stray high-frequency signals.

Passive components used with the WTA should preferably be surface mount, to minimize stray inductance. If surface-mount components are not used, component lead lengths should be kept to an absolute minimum.

Bypass each power supply directly to the ground plane with a 0.22μF ceramic capacitor, placed as close to the supply pins as possible. Bypass the ISET pin with a 0.22μF ceramic capacitor to the V+ pin. Keep capacitor lead lengths as short as possible to minimize series inductance; surface-mount (chip) capacitors are ideal for this application.

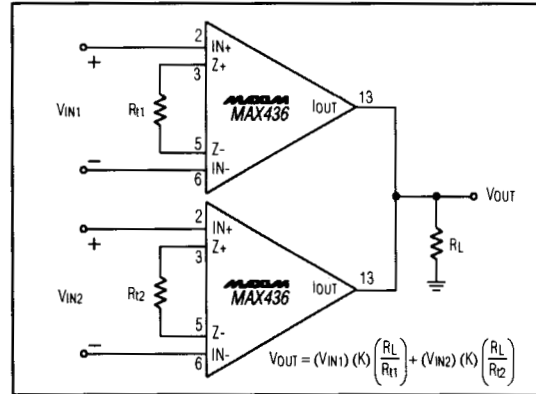

Figure 7. Summing Amplifier

Capacitive Load Driving

Since the WTA requires no feedback, phase shift due to capacitive loading of the output will not degrade the circuit stability. The primary effect of capacitive loading is a reduction in the output slew rate and bandwidth, which is limited by the rate at which the WTA output current can charge the capacitive load. Avoid capacitive coupling from the WTA output terminals to the input or transconductance terminals, since it introduces high-frequency feedback and possible oscillations.

Application Circuits

The WTA's unique architecture allows the implementation of many unique application circuits, some of which have been included here.

For the sake of clarity, bypass capacitors and the RSET resistor have not been shown in the following applications circuit schematics. The value of RSET is 5.9kΩ for every application circuit in Figures 3-16. For every application circuit in this data sheet, each power supply was bypassed to GND with a 0.22μF ceramic capacitor. The ISET pin was bypassed to V+ with a 0.22μF ceramic capacitor.

Wideband Transconductance Amplifiers

MAX435/MAX436

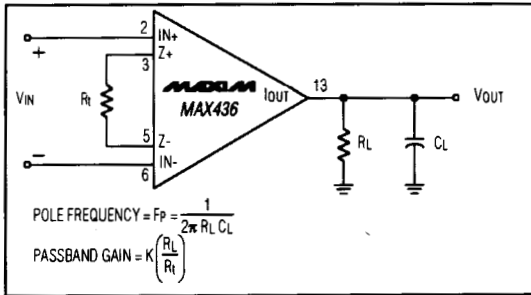

Figure 8. Lowpass Amplifier

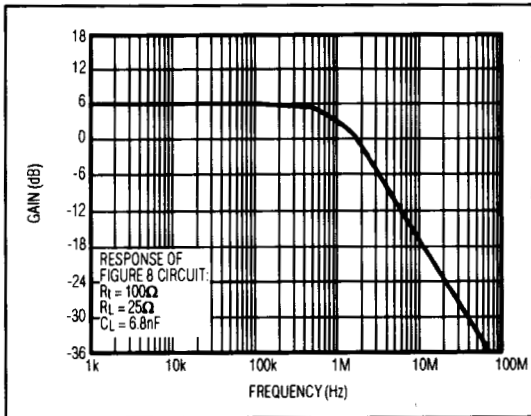

Figure 9. Lowpass Amplifier Gain vs. Frequency

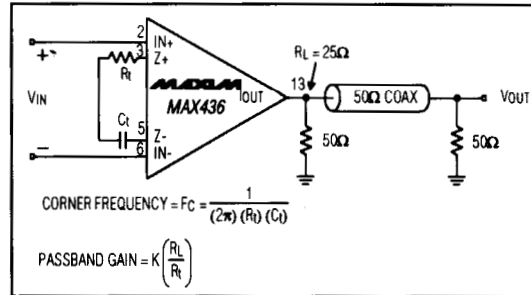

Figure 10. Highpass Amplifier

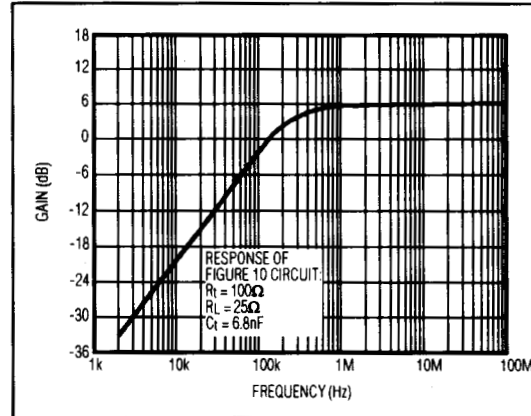

Figure 11. Highpass Amplifier Gain vs. Frequency

Coaxial Cable Drivers

To maximize power transfer and minimize distortion of high-speed signals, transmission lines must be terminated at the source and receiving ends with the characteristic impedance of the line itself. A 50Ω coaxial cable requires an impedance of 50Ω at each end for optimum performance.

With voltage-mode amplifiers, the transmitting end of a coaxial cable is typically back-terminated with a resistor in series with the amplifier output, since the voltage-mode amplifier's output has a very low impedance.

The WTA output is a current source, so its output impedance is relatively high (approximately 3.5kΩ). Therefore, when driving coaxial cables with the WTA, the back-termination resistor should be placed in parallel with the output impedance of the WTA, as shown in Figures 3 and 5. Note that back terminating cables in this manner will reduce the effective voltage gain of the circuit by a factor of 2.

The pulse response of the circuit in Figure 3 is shown in Figure 4, while Figure 6 is the pulse response of Figure 5's circuit.

Summing Amplifier

Two or more signals can be summed together by simply tying the output terminals of WTA's together as shown in Figure 7.

Lowpass Amplifier

A parallel RC network at the amplifier output will result in the lowpass amplifier circuit of Figure 8, with a -3dB corner frequency of:

$$F_c = \frac{1}{(2\pi) (R_L) (C_L)}$$

The response of Figure 8's circuit with $R_t = 100\Omega$, $C_L = 6.8nF$ and $R_L = 25\Omega$ is plotted in Figure 9.

Highpass Amplifier

A series RC network between the transconductance terminals, as shown in the circuit of Figure 10, will produce a highpass amplifier. The response of this circuit is plotted in Figure 11, for $R_t = 100\Omega$, $C_t = 6.8nF$ and $R_L = 25\Omega$.

Wideband Transconductance Amplifiers

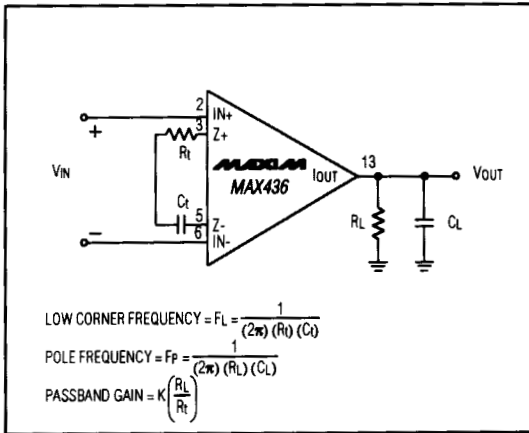

Figure 12. Bandpass Amplifier

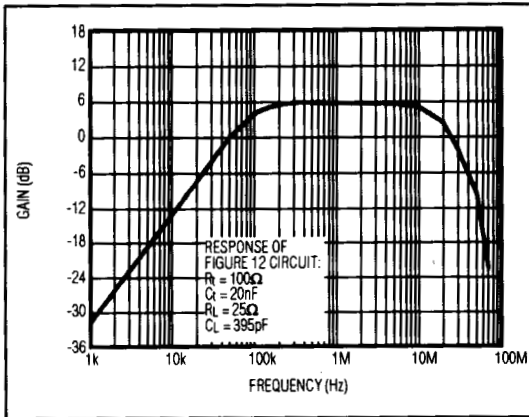

Figure 13. Bandpass Amplifier Gain vs. Frequency

Bandpass Amplifier

Since there is no interaction between the transconductance network impedance and the output load impedance, poles and zeros in the WTA transfer function can be independently set by the two impedance networks. The circuit in Figure 12 is a bandpass amplifier, with the low corner frequency set by the impedance of the transconductance network. The high corner frequency is set by the impedance of the RC network at the amplifier output. The passband gain is $(K) \times (R_L/R_t)$.

Figure 13 is a plot of the response of the circuit in Figure 12, with $R_t = 100\Omega$, $C_t = 20\text{nF}$, $R_L = 25\Omega$, and $C_L = 395\text{pF}$.

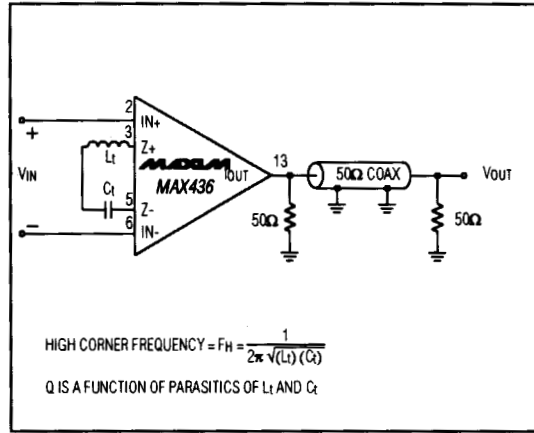

Figure 14. Tuned Amplifier

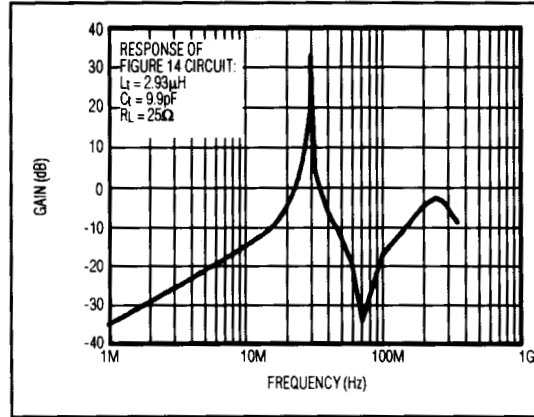

Figure 15. Tuned Amplifier Gain vs. Frequency

Tuned Amplifier

The circuit in Figure 14 is a tuned amplifier circuit, tuned to the resonant frequency of the LC transconductance network, or

$$F_C = \frac{1}{2\pi \sqrt{L_t C_t}}$$

The impedance of the transconductance network is a minimum at the resonant frequency, providing maximum amplifier gain at that frequency. The Q of the amplifier is a function of the parasitic components associated with the LC network. Figure 15 is the frequency response of the circuit in Figure 14, with $L_t = 2.93\mu\text{H}$ and $C_t = 9.9\text{pF}$.

Wideband Transconductance Amplifiers

MAX435/MAX436

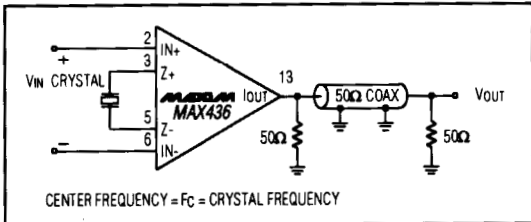

Figure 16. Crystal Tuned Amplifier

The high-frequency gain of this circuit (beyond the resonant frequency) can be further reduced by increasing the load capacitance.

Crystal Tuned Amplifier

If a higher Q and more accurate control of the tuned amplifier frequency is required, a crystal can replace the tuned LC network as the WTA transconductance element, as shown in the "Crystal Tuned Amplifier" circuit of Figure 16. The crystal's impedance is a minimum at its resonant frequency, resulting in maximum gain for the amplifier circuit at that frequency.

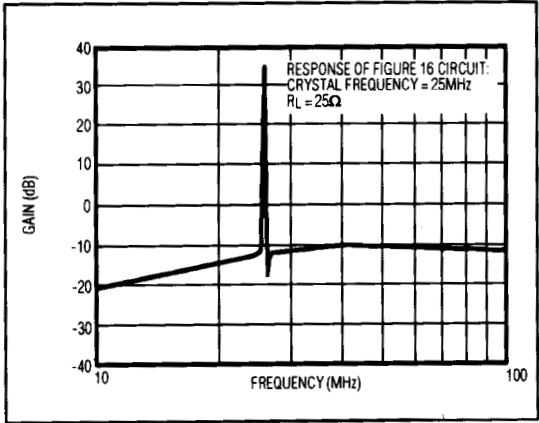

Figure 17. Crystal Tuned Amplifier Gain vs. Frequency

The frequency response of Figure 16's circuit with a 25MHz crystal is shown in Figure 17.

Video Twisted-Pair Driver/Receiver Circuit

For distances less than about 5000 ft. (1500m), a single channel of baseband (composite) video can be transmitted with surprisingly high quality across twisted-pair cabling, saving significant cost over traditional coaxial cabling. When using twisted pair as a transmission medium, two things are of highest importance: balanced (differential) transmission, to minimize common-mode noise, and proper termination to minimize reflections. The MAX435/MAX436, with 53dB CMRR at 10MHz and high input and output impedance, are well suited for this application.

Figure 18's circuit illustrates the MAX435 and MAX436 used as a driver/receiver circuit for twisted-pair video transmissions. One differential output MAX435 drives the balanced twisted pair from a ground-referred input signal, eliminating the need for a balun transformer or two single-ended output drivers.

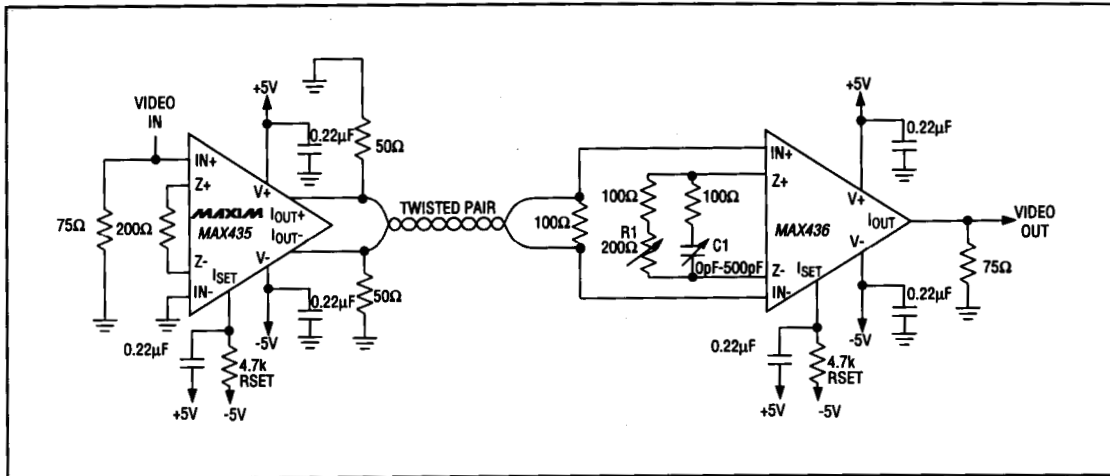

Figure 18. Video Twisted Pair Driver/Receiver Circuit

Wideband Transconductance Amplifiers

The receiver circuit uses the single-ended output MAX436 for balanced to single-ended line conversion. The 100Ω resistor from IN+ to IN- provides proper line termination. The transconductance network (from Z+ to Z-) performs the gain adjustment (+6dB), as well as line equalization. Line equalization is sometimes required to boost the high-frequency gain of the receiver to account for the limited bandwidth of the twisted pair.

In Figure 18's circuit, compensation is achieved by adjusting R1 for proper **brightness** (to boost overall gain to compensate for ohmic losses), and C1 for best **color** (to add a zero/pole pair to extend the bandwidth). Since this equalization is done on the receiver end, the end user simply views the screen and adjusts the controls for the best picture. For many NTSC applications, this line equalization may not be necessary, since the NTSC monitor performs a fair amount of loss equalization by calibrating to the test patterns in the vertical interval test signal (VITS).

Ordering Information (continued)

PART	TEMP. RANGE	PIN-PACKAGE
MAX436CPD	0°C to +70°C	14 Plastic DIP
MAX436CSD	0°C to +70°C	14 SO
MAX436C/D	0°C to +70°C	Dice*
MAX436EPD	-40°C to +85°C	14 Plastic DIP
MAX436ESD	-40°C to +85°C	14 SO
MAX436MJD	-55°C to +125°C	14 CERDIP

* Dice are specified at $T_A = +25^\circ\text{C}$, DC parameters only.

Chip Topography

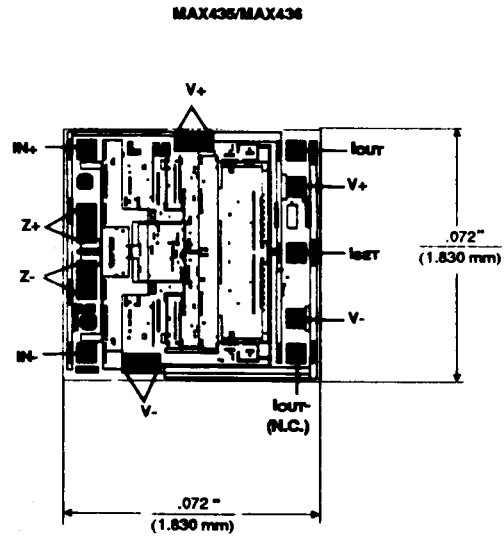

() are for MAX436 only.

TRANSISTOR COUNT: 230;
SUBSTRATE CONNECTED TO V-.

Maxim cannot assume responsibility for use of any circuitry other than circuitry entirely embodied in a Maxim product. No circuit patent licenses are implied. Maxim reserves the right to change the circuitry and specifications without notice at any time.

16 Maxim Integrated Products, 120 San Gabriel Drive, Sunnyvale, CA 94086 (408) 737-7600

© 1993 Maxim Integrated Products Printed USA **MAXIM** is a registered trademark of Maxim Integrated Products.

Mouser Electronics

Authorized Distributor

Click to View Pricing, Inventory, Delivery & Lifecycle Information:

Maxim Integrated:

[MAX435CPD](#) [MAX435CSD+](#) [MAX435EPD](#) [MAX435ESD](#) [MAX435ESD+](#) [MAX435MJD](#) [MAX436CPD](#)
[MAX436CSD+](#) [MAX436EPD](#) [MAX436ESD+](#) [MAX436MJD](#) [MAX435C/D](#) [MAX435CSD](#) [MAX435CSD+T](#)
[MAX435CSD-T](#) [MAX435ESD+T](#) [MAX435ESD-T](#) [MAX436CSD](#) [MAX436CSD+T](#) [MAX436CSD-T](#) [MAX436ESD](#)
[MAX436ESD+T](#) [MAX436ESD-T](#)