

**Surge Ratings**

Series	$I_{PP}$										$I_{TSM}$ 50/60 Hz	di/dt
	0.2/310 <sup>1</sup>	2/10 <sup>1</sup>	8/20 <sup>1</sup>	10/160 <sup>1</sup>	10/560 <sup>1</sup>	5/320 <sup>1</sup>	10/360 <sup>1</sup>	10/1000 <sup>1</sup>	5/310 <sup>1</sup>	10/700 <sup>1</sup>		
	0.5/700 <sup>2</sup>	2/10 <sup>2</sup>	1.2/50 <sup>2</sup>	10/160 <sup>2</sup>	10/560 <sup>2</sup>	9/720 <sup>2</sup>	10/360 <sup>2</sup>	10/1000 <sup>2</sup>	10/700 <sup>2</sup>			
	A min	A min	A min	A min	A min	A min	A min	A min	A min	A min	A/μs max	
A	20	150	150	90	50	75	75	45	75	25	500	
C	50	500	400	200	150	200	175	100	200 <sup>3</sup>	35	500	

Notes:  
 1 Current waveform in μs  
 2 Voltage waveform in μs  
 3 For surge rating of P4500SCMCLRP 10/700μs min=150A

- Peak pulse current rating ( $I_{PP}$ ) is repetitive and guaranteed for the life of the product that remains in thermal equilibrium.  
 -  $I_{PP}$  ratings applicable over temperature range of -40°C to +85°C  
 - The component must initially be in thermal equilibrium with -40°C ≤  $T_J$  ≤ +150°C

**Thermal Considerations**

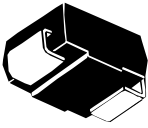
Package	Symbol	Parameter	Value	Unit
DO-214AA 	$T_J$	Operating Junction Temperature Range	-40 to +150	°C
	$T_S$	Storage Temperature Range	-65 to +150	°C
	$R_{θJA}$	Thermal Resistance: Junction to Ambient	90	°C/W

**V-I Characteristics**

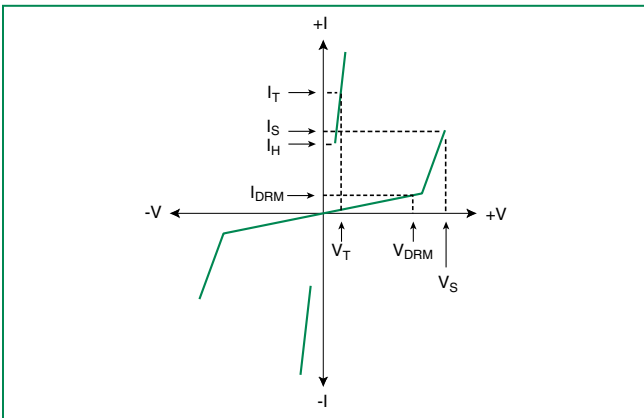

**$t_r \times t_d$  Pulse Waveform**

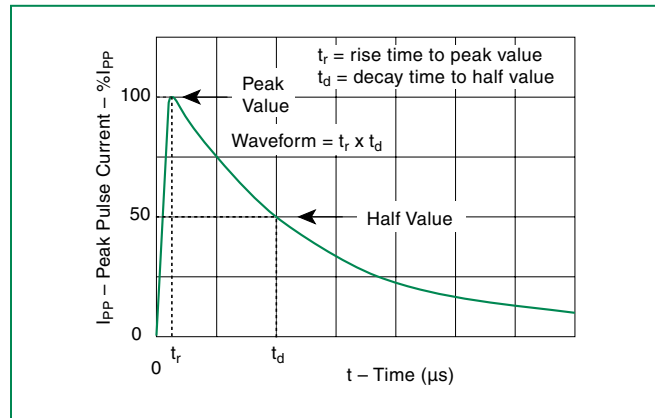

**Normalized  $V_S$  Change vs. Junction Temperature**

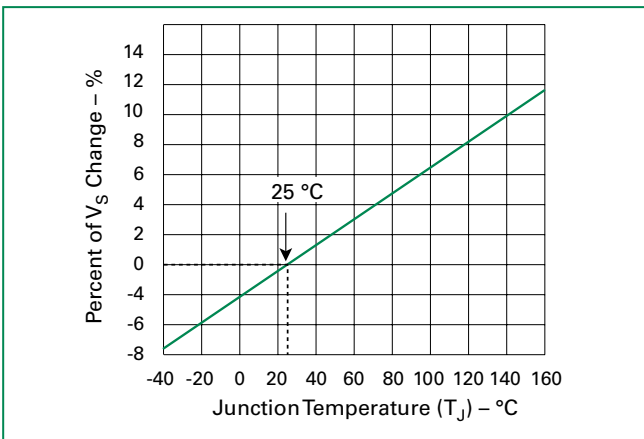

**Normalized DC Holding Current vs. Case Temperature**

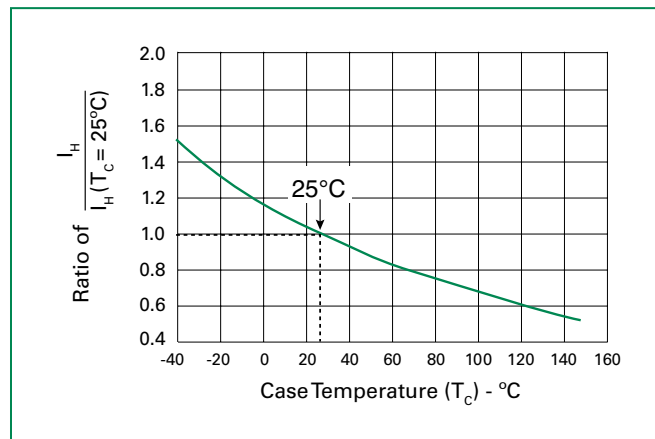

### Soldering Parameters

Reflow Condition	Pb-Free assembly (see Fig. 1)	
Pre Heat	-Temperature Min ( $T_{s(min)}$ )	+150°C
	-Temperature Max ( $T_{s(max)}$ )	+200°C
	-Time (Min to Max) ( $t_s$ )	60-180 secs.
Average ramp up rate (Liquidus Temp ( $T_L$ ) to peak)	3°C/sec. Max.	
$T_{s(max)}$ to $T_L$ - Ramp-up Rate	3°C/sec. Max.	
Reflow	-Temperature ( $T_L$ ) (Liquidus)	+217°C
	-Temperature ( $t_L$ )	60-150 secs.
Peak Temp ( $T_p$ )	+260(+0/-5)°C	
Time within 5°C of actual PeakTemp ( $t_p$ )	30 secs. Max.	
Ramp-down Rate	6°C/sec. Max.	
Time 25°C to Peak Temp ( $T_p$ )	8 min. Max.	
Do not exceed	+260°C	

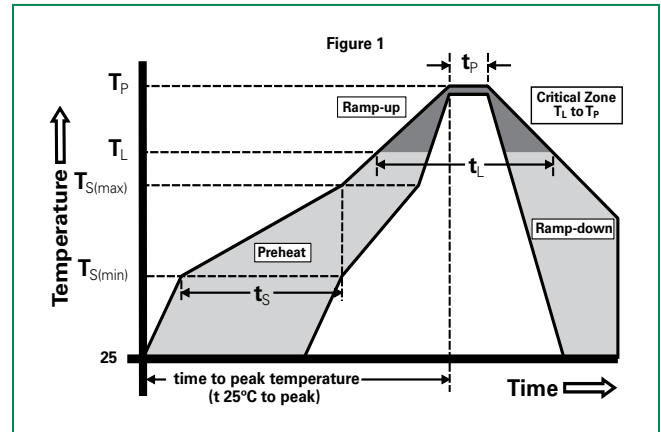

### Physical Specifications

Lead Material	Copper Alloy
Terminal Finish	100% Matte-Tin Plated
Body Material	UL Recognized epoxy meeting flammability classification V-0

### Environmental Specifications

High Temp Voltage Blocking	80% Rated $V_{DRM}$ ( $V_{AC Peak}$ ) +125°C or +150°C, 504 or 1008 hrs. MIL-STD-750 (Method 1040) JEDEC, JESD22-A-101
Temp Cycling	-65°C to +150°C, 15 min. dwell, 10 up to 100 cycles. MIL-STD-750 (Method 1051) EIA/JEDEC, JESD22-A104
Biased Temp & Humidity	52 $V_{DC}$ (+85°C) 85%RH, 504 up to 1008 hrs. EIA/JEDEC, JESD22-A-101
High Temp Storage	+150°C 1008 hrs. MIL-STD-750 (Method 1031) JEDEC, JESD22-A-101
Low Temp Storage	-65°C, 1008 hrs.
Thermal Shock	0°C to +100°C, 5 min. dwell, 10 sec. transfer, 10 cycles. MIL-STD-750 (Method 1056) JEDEC, JESD22-A-106
Autoclave (Pressure Cooker Test)	+121°C, 100%RH, 2atm, 24 up to 168 hrs. EIA/JEDEC, JESD22-A-102
Resistance to Solder Heat	+260°C, 30 secs. MIL-STD-750 (Method 2031)
Moisture Sensitivity Level	85%RH, +85°C, 168 hrs., 3 reflow cycles (+260°C Peak). JEDEC-J-STD-020, Level 1

### Additional Information



Datasheet



Resources



Samples

**Dimensions – DO-214AA**

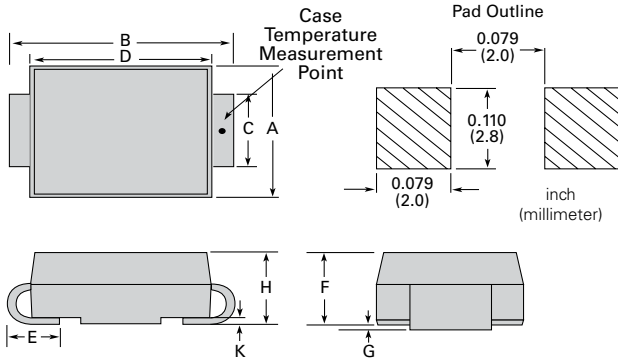

Dimensions	Inches		Millimeters	
	Min	Max	Min	Max
A	0.130	0.156	3.30	3.95
B	0.201	0.220	5.10	5.60
C	0.077	0.087	1.95	2.20
D	0.159	0.181	4.05	4.60
E	0.030	0.063	0.75	1.60
F	0.075	0.096	1.90	2.45
G	0.002	0.008	0.05	0.20
H	0.077	0.104	1.95	2.65
K	0.006	0.016	0.15	0.41

**Part Numbering**

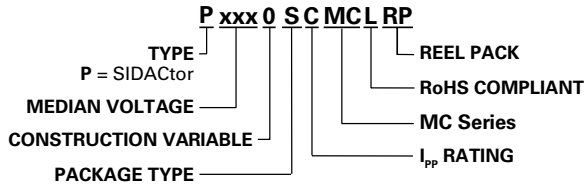

**Part Marking**

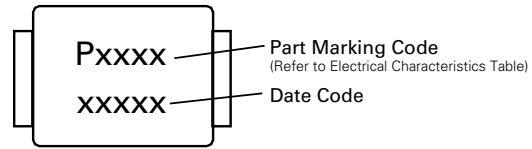

**Packing Options**

Package Type	Description	Quantity	Added Suffix	Industry Standard
S	DO-214AA Tape & Reel Pack	2500	N/A	EIA-481-D

**Tape and Reel Specification – DO-214AA**

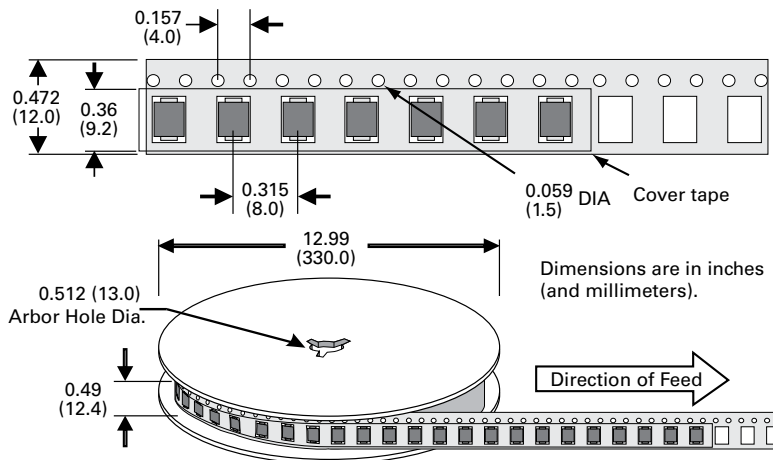

**Disclaimer Notice - Information furnished is believed to be accurate and reliable. However, users should independently evaluate the suitability of and test each product selected for their own applications. Littelfuse products are not designed for, and may not be used in, all applications. Read complete Disclaimer Notice at [www.littelfuse.com/disclaimer-electronics](http://www.littelfuse.com/disclaimer-electronics).**

# Mouser Electronics

Authorized Distributor

Click to View Pricing, Inventory, Delivery & Lifecycle Information:

## Littelfuse:

[P0300SBMC](#) [P0640SCMC](#) [P0080SAMC](#) [P1100SCMC](#) [P1500SCMC](#) [P1800SCMC](#) [P0900SCMC](#) [P0720SCMC](#)  
[P2600SCMC](#) [P2000SCMC](#) [P3500SCMC](#) [P3100SCMC](#) [P2300SCMC](#) [P1300SCMC](#) [P0300SCMC](#) [P0300SAMC](#)  
[P0080SBMC](#) [P0080SCMC](#) [P0080SBMCLRP](#) [P0300SCMCLRP](#) [P0080SAMCRP](#) [P1800SCMCLRP](#) [P0080SBMCRP](#)  
[P2600SCMCRP](#) [P0300SBMCRP](#) [P2300SCMCRP](#) [P0640SCMCLRP](#) [P3100SCMCRP](#) [P1500SCMCLRP](#)  
[P3500SCMCRP](#) [P0080SCMCRP](#) [P0640SCMCRP](#) [P0720SCMCLRP](#) [P0900SCMCRP](#) [P0300SCMCRP](#)  
[P0300SAMCLRP](#) [P0720SCMCRP](#) [P1500SCMCRP](#) [P1100SCMCRP](#) [P1800SCMCRP](#) [P0080SAMCLRP](#)  
[P0220SBMCLRP](#) [P0220SBMCRP](#) [P0220SCMCLRP](#) [P2100SCMCLRP](#) [P3500SCMCLRP](#) [P1100SCMCLRP](#)  
[P2600SCMCLRP](#) [P2300SCMCLRP](#) [P0300SAMCRP](#) [P0900SCMCLRP](#) [P1300SCMCRP](#) [P3100SCMCLRP](#)  
[P0220SARP](#) [P0080SCMCLRP](#) [P0300SBMCLRP](#) [P1300SCMCLRP](#) [P0220SAMCRP](#) [P0220SAMCLRP](#)  
[P4500SCMCLRP](#)