

CMUD6263E CMUD6263CE
 CMUD6263AE CMUD6263SE

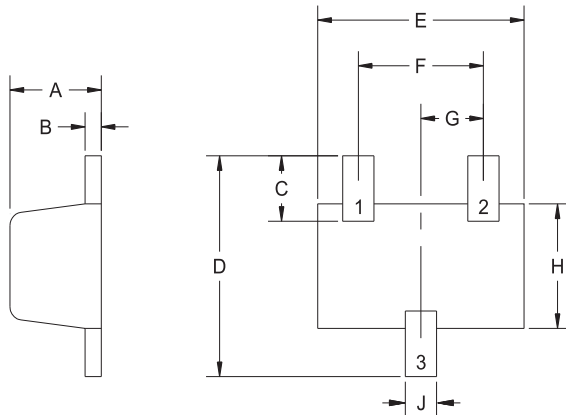

**ENHANCED SPECIFICATION
 SURFACE MOUNT SILICON
 SCHOTTKY DIODES**

SOT-523 CASE - MECHANICAL OUTLINE



(Bottom View)

R2

SYMBOL	DIMENSIONS			
	INCHES		MILLIMETERS	
	MIN	MAX	MIN	MAX
A	0.023	0.031	0.58	0.78
B	0.002	0.008	0.04	0.20
C	0.013	0.021	0.34	0.54
D	0.059	0.067	1.50	1.70
E	0.059	0.067	1.50	1.70
F	0.035	0.043	0.90	1.10
G	0.020		0.50	
H	0.031	0.039	0.78	0.98
J	0.010	0.014	0.25	0.35

SOT-523 (REV: R2)

PIN CONFIGURATIONS

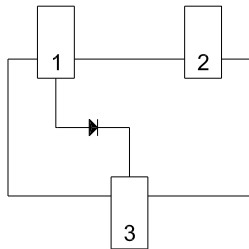

CMUD6263E

LEAD CODE:

- 1) Anode
- 2) No Connection
- 3) Cathode

MARKING CODE: C63

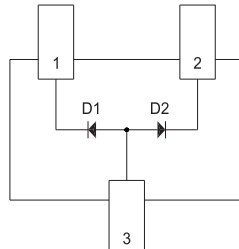

CMUD6263AE

LEAD CODE:

- 1) Cathode D1
- 2) Cathode D2
- 3) Anode D1, D2

MARKING CODE: C6A

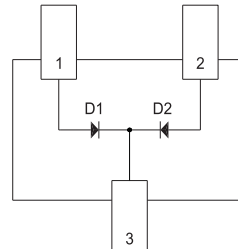

CMUD6263CE

LEAD CODE:

- 1) Anode D1
- 2) Anode D2
- 3) Cathode D1, D2

MARKING CODE: C6C

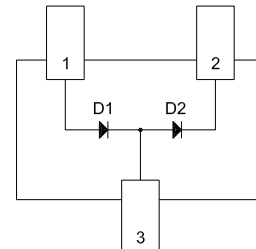

CMUD6263SE

LEAD CODE:

- 1) Anode D1
- 2) Cathode D2
- 3) Anode D2, Cathode D1

MARKING CODE: 6CS

R4 (18-September 2020)

CMUD6263E CMUD6263CE
 CMUD6263AE CMUD6263SE



**ENHANCED SPECIFICATION
 SURFACE MOUNT SILICON
 SCHOTTKY DIODES**

TYPICAL ELECTRICAL CHARACTERISTICS

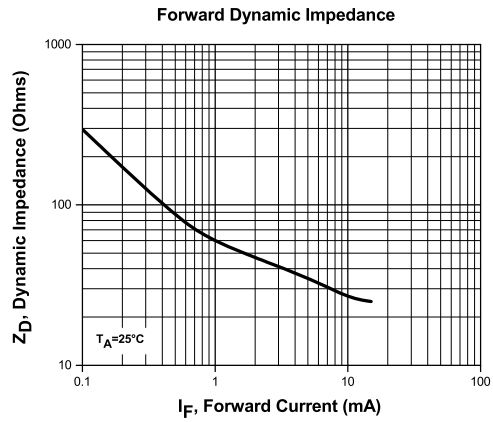
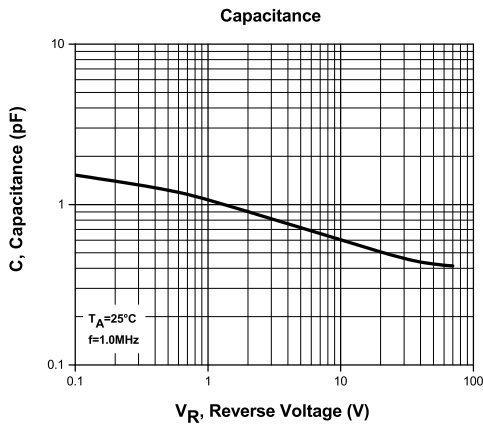
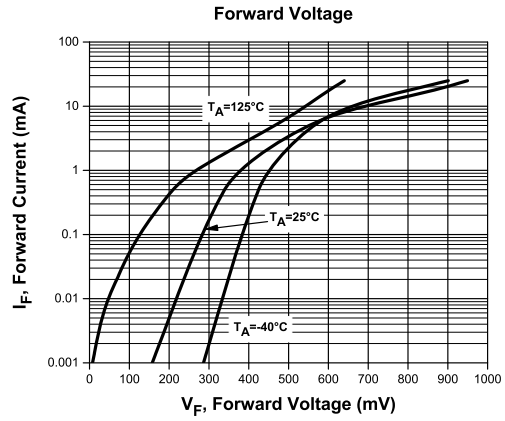
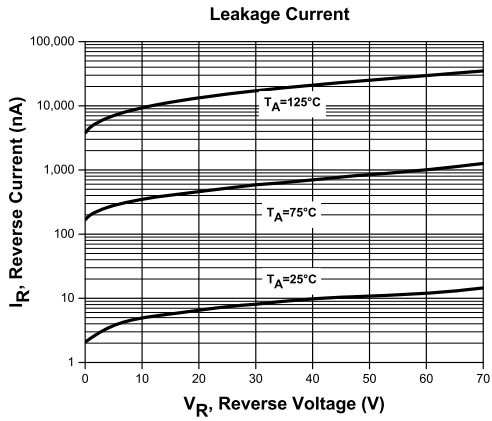

R4 (18-September 2020)

CMUD6263E CMUD6263CE
CMUD6263AE CMUD6263SE

**ENHANCED SPECIFICATION
SURFACE MOUNT SILICON
SCHOTTKY DIODES**



TYPICAL ELECTRICAL CHARACTERISTICS

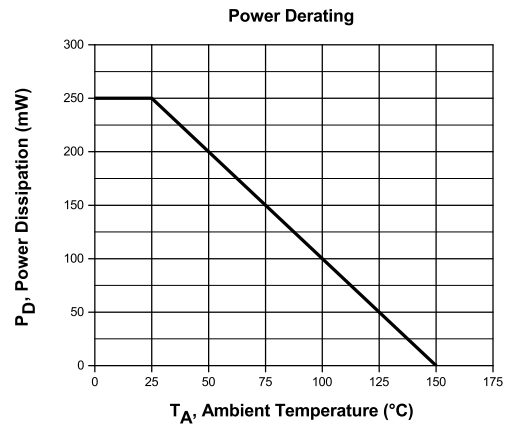
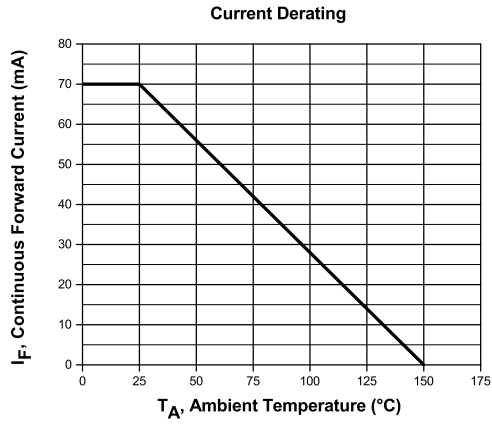

R4 (18-September 2020)

OUTSTANDING SUPPORT AND SUPERIOR SERVICES



PRODUCT SUPPORT

Central's operations team provides the highest level of support to insure product is delivered on-time.

- Supply management (Customer portals)
- Inventory bonding
- Consolidated shipping options
- Custom bar coding for shipments
- Custom product packing

DESIGNER SUPPORT/SERVICES

Central's applications engineering team is ready to discuss your design challenges. Just ask.

- Free quick ship samples (2nd day air)
- Online technical data and parametric search
- SPICE models
- Custom electrical curves
- Environmental regulation compliance
- Customer specific screening
- Up-screening capabilities
- Special wafer diffusions
- PbSn plating options
- Package details
- Application notes
- Application and design sample kits
- Custom product and package development

REQUESTING PRODUCT PLATING

1. If requesting Tin/Lead plated devices, add the suffix "TIN/LEAD" to the part number when ordering (example: 2N2222A TIN/LEAD).
2. If requesting Lead (Pb) Free plated devices, add the suffix "PBFREE" to the part number when ordering (example: 2N2222A PBFREE).

CONTACT US

Corporate Headquarters & Customer Support Team

Central Semiconductor Corp.
145 Adams Avenue
Hauppauge, NY 11788 USA
Main Tel: (631) 435-1110
Main Fax: (631) 435-1824
Support Team Fax: (631) 435-3388
www.centrasemi.com

Worldwide Field Representatives:
www.centrasemi.com/wwreps

Worldwide Distributors:
www.centrasemi.com/wwdistributors

For the latest version of Central Semiconductor's **LIMITATIONS AND DAMAGES DISCLAIMER**, which is part of Central's Standard Terms and Conditions of sale, visit: www.centrasemi.com/terms