

## RATING AND CHARACTERISTIC CURVES (CDBD620-G Thru. CDBD6100-G)

FIG.1-TYPICAL FORWARD CURRENT DERATING CURVE

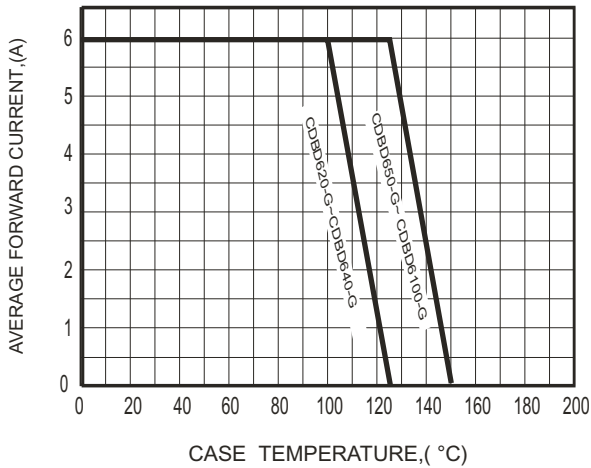

FIG.2-TYPICAL FORWARD CHARACTERISTICS

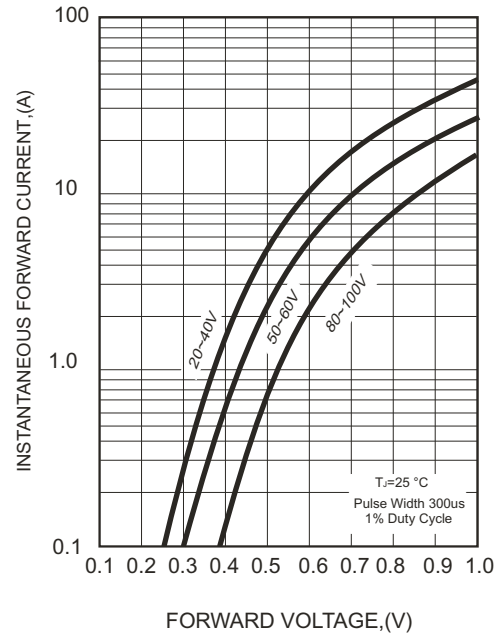

FIG.3-MAXIMUM NON-REPETITIVE FORWARD SURGE CURRENT

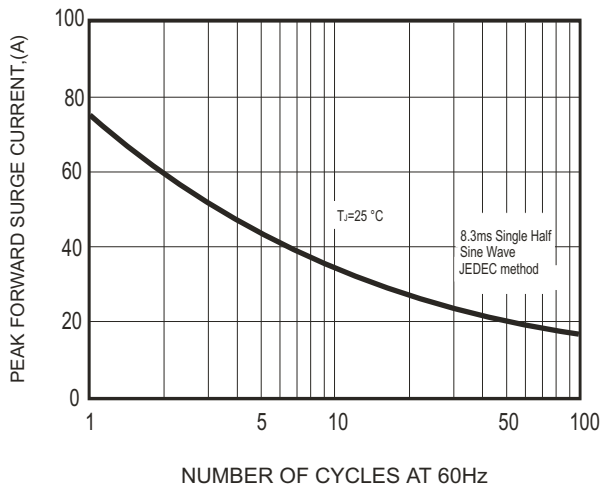
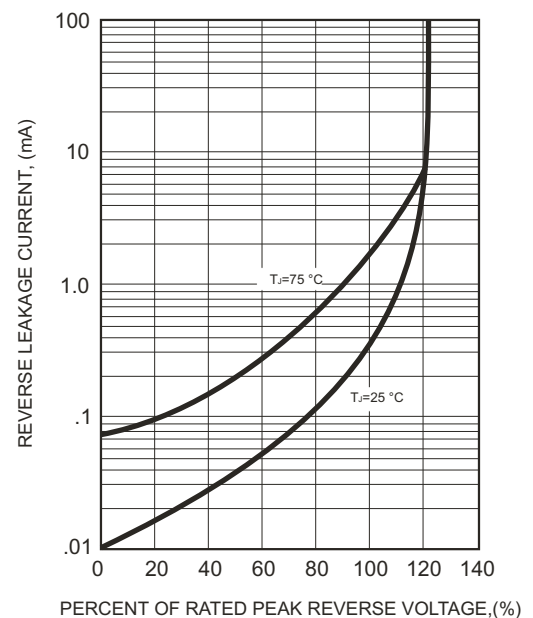
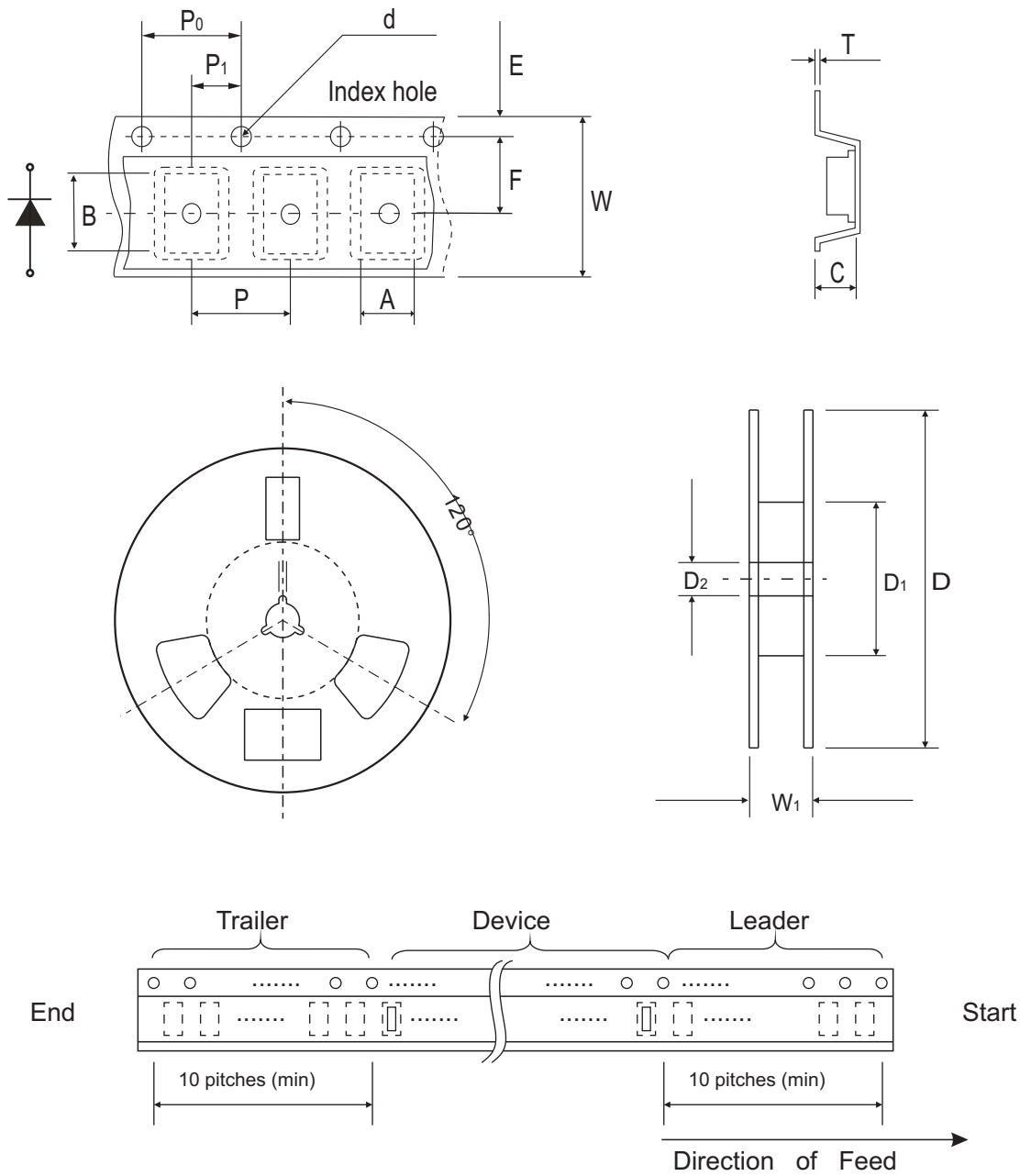

FIG.4 - TYPICAL REVERSE CHARACTERISTICS



## Reel Taping Specification



TO-252/DPAK	SYMBOL	A	B	C	d	D	D1	D2
	(mm)	6.90 ± 0.10	10.50 ± 0.10	2.70 ± 0.10	1.50 ± 0.10	330.00 ± 2.00	50.0 MIN.	13.0 ± 0.50
	(inch)	0.272 ± 0.004	0.413 ± 0.004	0.106 ± 0.004	0.059 ± 0.004	13.00 ± 0.079	1.969 MIN.	0.512 ± 0.020

TO-252/DPAK	SYMBOL	E	F	P	P0	P1	T	W	W1
	(mm)	1.75 ± 0.10	7.50 ± 0.10	8.00 ± 0.10	4.00 ± 0.10	2.00 ± 0.10	0.23 ± 0.10	16.00 ± 0.30	22.00 ± 1.0
	(inch)	0.069 ± 0.004	0.295 ± 0.004	0.315 ± 0.004	0.157 ± 0.004	0.079 ± 0.004	0.009 ± 0.004	0.630 ± 0.012	0.866 ± 0.039

## Marking Code

Part Number	Marking Code
CDBD620-G	SK620Y
CDBD640-G	SK640Y
CDBD650-G	SK650Y
CDBD660-G	SK660Y
CDBD680-G	SK680Y
CDBD6100-G	SK6100Y

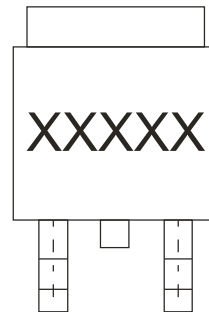

XXXXXX / XXXXXX = Product type marking code

## Suggested PAD Layout

SIZE	TO-252 / DPAK	
	(mm)	(inch)
A	6.90	0.272
B	2.30	0.091
C	11.60	0.457
X1	7.00	0.276
X2	1.50	0.059
Y1	7.00	0.276
Y2	2.50	0.098

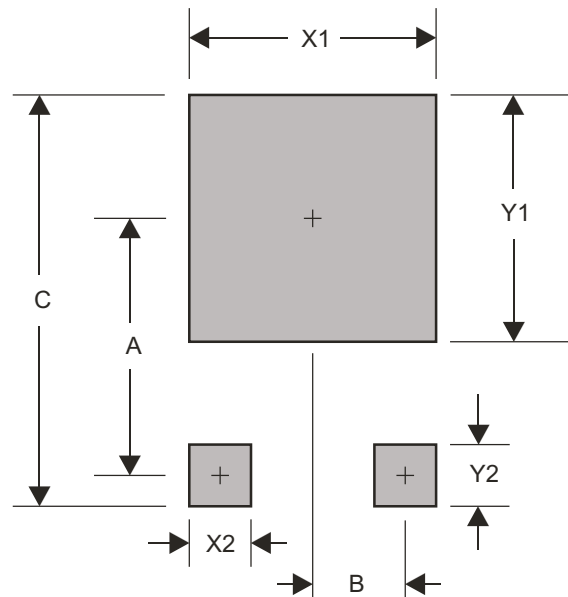

## Standard Packaging

Case Type	REEL PACK	
	REEL ( pcs )	Reel Size (inch)
TO-252/DPAK	3,000	13

# Mouser Electronics

Authorized Distributor

Click to View Pricing, Inventory, Delivery & Lifecycle Information:

[Comchip Technology:](#)

[CDBD640-G](#)