

Absolute Maximum Ratings

V_{CC} , $RS+$, $RS-$ to GND	-0.3V to +30V
OUT to GND	-0.3V to the lesser of ($V_{CC} + 0.3V$) or +15V
CIN1, CIN2, RESET to GND	-0.3V to the lesser of ($V_{CC} + 0.3V$) or +12V
Differential Input Voltage ($V_{RS+} - V_{RS-}$)	$\pm 0.3V$
COUT1, COUT2 to GND	-0.3V to +6.0V
Current into Any Pin	$\pm 10mA$

Continuous Power Dissipation ($T_A = +70^\circ C$)	
8-Pin μMAX (derate 4.1mW/ $^\circ C$ above +70 $^\circ C$)	330mW
8-Pin SO (derate 5.9mW/ $^\circ C$ above +70 $^\circ C$)	471mW
10-Pin μMAX (derate 5.6mW/ $^\circ C$ above +70 $^\circ C$)	444mW
14-Pin SO (derate 8.3mW/ $^\circ C$ above +70 $^\circ C$)	667mW
Operating Temperature Range	-40 $^\circ C$ to +85 $^\circ C$
Junction Temperature	+150 $^\circ C$
Storage Temperature Range	-65 $^\circ C$ to +150 $^\circ C$
Lead Temperature (soldering, 10s)	+300 $^\circ C$
Soldering Temperature (reflow)	+260 $^\circ C$

Stresses beyond those listed under "Absolute Maximum Ratings" may cause permanent damage to the device. These are stress ratings only, and functional operation of the device at these or any other conditions beyond those indicated in the operational sections of the specifications is not implied. Exposure to absolute maximum rating conditions for extended periods may affect device reliability.

Electrical Characteristics

($V_{CC} = +2.7V$ to +28V, $V_{RS+} = 0$ to +28V, $V_{SENSE} = 0V$, $V_{RESET} = 0V$, $R_{LOAD} = 1M\Omega$, $T_A = T_{MIN}$ to T_{MAX} , unless otherwise noted. Typical values are at $T_A = +25^\circ C$.) (Note 1)

PARAMETER	SYMBOL	CONDITIONS	MIN	TYP	MAX	UNITS	
Operating Voltage Range (Note 2)	V_{CC}		2.7		28	V	
Common-Mode Input Range (Note 3)	V_{CMR}		0		28	V	
Common-Mode Rejection	CMR	$V_{RS+} > 2V$		85		dB	
Supply Current	I_{CC}	$V_{RS+} > 2V$, $V_{SENSE} = 5mV$		50	100	μA	
Leakage Current	I_{RS+} , I_{RS-}	$V_{CC} = 0V$, $V_{RS+} = 28V$		± 0.015	± 0.5	μA	
Input Bias Current	I_{RS+}	$V_{RS+} > 2V$	0		2.5	μA	
		$V_{RS+} \leq 2V$	-25		2.0		
	I_{RS-}	$V_{RS+} > 2V$	0		4		
		$V_{RS+} \leq 2V$	-50		4		
Full-Scale Sense Voltage (Note 4)	V_{SENSE}	Gain = +20V/V, +50V/V, $V_{RS+} = 12V$	150	170		mV	
		Gain = +100V/V, $V_{RS+} = 12V$	100	120			
Input Offset Voltage	V_{OS}	$V_{CC} = V_{RS+} = 12V$ (Note 11)	$T_A = +25^\circ C$	0.1	1	mV	
			$T_A = T_{MIN}$ to T_{MAX}		2		
Total OUT Voltage Error (Note 5)	V_{OUT}	$V_{SENSE} = 100mV$ (Note 6)	$V_{CC} = 12V$, $V_{RS+} = 12V$	$T_A = +25^\circ C$	± 0.30	± 2	%
				$T_A = T_{MIN}$ to T_{MAX}		± 3	
			$V_{CC} = 28V$, $V_{RS+} = 28V$	$T_A = +25^\circ C$	± 0.35	± 2	
				$T_A = T_{MIN}$ to T_{MAX}		± 3	
		$V_{CC} = 12V$, $V_{RS+} = 0.1V$	± 5.0				
$V_{SENSE} = 6.25mV$, $V_{CC} = 12V$, $V_{RS+} = 12V$ (Note 7)	± 5.0						
OUT Voltage Low	V_{OUT}	$V_{CC} = 2.7V$, $V_{RS+} = 12V$	$I_{OUT} = 10\mu A$	2.5		mV	
			$I_{OUT} = 100\mu A$	8.5	65		
OUT Voltage High	$V_{CC} - V_{OH}$	$V_{CC} = 2.7V$, $I_{OUT} = -500\mu A$, $V_{RS+} = 12V$			0.25	V	

Electrical Characteristics (continued)

($V_{CC} = +2.7V$ to $+28V$, $V_{RS+} = 0$ to $+28V$, $V_{SENSE} = 0V$, $V_{RESET} = 0V$, $R_{LOAD} = 1M\Omega$, $T_A = T_{MIN}$ to T_{MAX} , unless otherwise noted. Typical values are at $T_A = +25^\circ C$.) (Note 1)

PARAMETER	SYMBOL	CONDITIONS		MIN	TYP	MAX	UNITS
-3dB Bandwidth	BW	$V_{RS+} = 12V$, $V_{CC} = 12V$, $C_{LOAD} = 10pF$	$V_{SENSE} = 100mV$, Gain = +20V/V		200		kHz
			$V_{SENSE} = 100mV$, Gain = +50V/V		120		
			$V_{SENSE} = 100mV$, Gain = +100V/V		110		
			$V_{SENSE} = 6.25mV$		50		
Gain	A_V	MAX437_T			+20		V/V
		MAX437_F			+50		
		MAX437_H			+100		
Gain Accuracy	ΔA_V	$V_{SENSE} = 20mV$ to $150mV$; $V_{CC} = 12V$; $V_{RS+} = 12V$; Gain = 20, 50	$T_A = +25^\circ C$		± 0.3	± 1.7	%
			$T_A = -40^\circ C$ to $+85^\circ C$			± 2.7	
		$V_{SENSE} = 20mV$ to $100mV$, $V_{CC} = 12V$, $V_{RS+} = 12V$, Gain = 100	$T_A = +25^\circ C$		± 0.3	± 1.7	
			$T_A = -40^\circ C$ to $+85^\circ C$			± 2.7	
OUT Settling Time to 1% of Final Value		Gain = +20V/V, $V_{CC} = 12V$, $V_{RS+} = 12V$, $C_{LOAD} = 10pF$	$V_{SENSE} = 6.25mV$ to $100mV$		20		μs
			$V_{SENSE} = 100mV$ to $6.25mV$		20		
Capacitive Load Stability		No sustained oscillations			1000		pF
OUT Output Resistance	R_{OUT}	$V_{SENSE} = 100mV$			1.5		Ω
Power-Supply Rejection	PSR	$V_{OUT} = 2V$, $V_{RS+} > 2V$		72	87		dB
Power-Up Time to 1% of Final Value		$V_{SENSE} = 100mV$, $C_{LOAD} = 10pF$, $V_{CC} = 12V$, $V_{RS+} = 12V$			0.5		ms
Saturation Recovery Time (Note 8)		$V_{CC} = 12V$, $V_{RS+} = 12V$, $C_{LOAD} = 10pF$			0.1		ms
COMPARATOR (Note 9)							
Comparator Threshold	V_{TH}	$T_A = +25^\circ C$		590	600	610	mV
		$T_A = T_{MIN}$ to T_{MAX}		586		614	
Comparator Hysteresis					-9		mV
Input Bias Current	I_B				± 2.2	± 15	nA
Propagation Delay		$C_L = 10pF$, $R_L = 10k\Omega$ pull-up to 5V, 5mV of overdrive			4		μs
Output Low Voltage	V_{OL}	$I_{SINK} = 1mA$				0.6	V

Electrical Characteristics (continued)

(VCC = +2.7V to +28V, VRS+ = 0 to +28V, VSENSE = 0V, VRESET = 0V, RLOAD= 1MΩ, TA = TMIN to TMAX, unless otherwise noted. Typical values are at TA = +25°C.) (Note 1)

PARAMETER	SYMBOL	CONDITIONS	MIN	TYP	MAX	UNITS
Output High Leakage Current		VCC = 28V, VPULL-UP = 5V (Note 10)			1	μA
RESET Input High Voltage	VIH		2.0			V
RESET Input Low Voltage	VIL				0.8	V
Logic Input Current	IIL, IIH	VIL = 0, VIH = 5.5V, VCC = 28V	-0.5		0.5	μA
Minimum RESET Pulse Width	tRPW			1.5		μs
RESET Propagation Delay	tRPD			3		μs

- Note 1:** All devices are 100% production tested at TA = +25°C. All temperature limits are guaranteed by design.
- Note 2:** Guaranteed by PSR test.
- Note 3:** Guaranteed by OUT Voltage Error test.
- Note 4:** Guaranteed by Gain Accuracy test. Output voltage is internally clamped not to exceed 12V.
- Note 5:** Total OUT Voltage Error and Full-Scale Accuracy are the sum of gain and offset voltage errors.
- Note 6:** Measured at IOUT = -500μA (RLOAD = 4kΩ for gain of +20V/V, RLOAD = 10kΩ for gain of +50V/V, RLOAD = 20kΩ for gain of +100V/V).
- Note 7:** +6.25mV = 1/16 of +100mV full-scale voltage.
- Note 8:** The device will not experience phase reversal when overdriven.
- Note 9:** All comparator tests are done with VRS+ = +12V.
- Note 10:** VPULL-UP is defined as an externally applied voltage through a resistor to pull up the comparator output.
- Note 11:** VOS is extrapolated from the gain accuracy test.

Typical Operating Characteristics

(VRS+ = +12V, VCC = +12V, RLOAD = 1MΩ, VRESET = 0V, VSENSE = 100mV, VPULL-UP = +5V, RPULL-UP = 10kΩ, TA = +25°C, unless otherwise noted.)

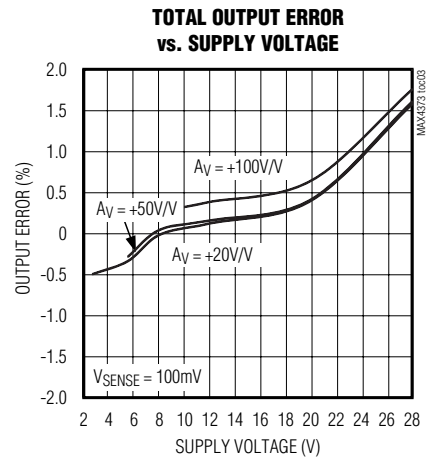
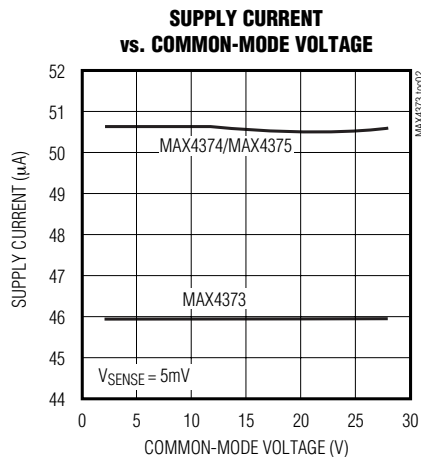
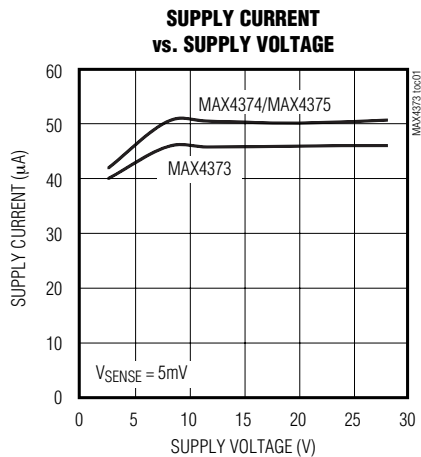

Typical Operating Characteristics (continued)

($V_{RS+} = +12V$, $V_{CC} = +12V$, $R_{LOAD} = 1M\Omega$, $V_{RESET} = 0V$, $V_{SENSE} = 100mV$, $V_{PULL-UP} = +5V$, $R_{PULL-UP} = 10k\Omega$, $T_A = +25^\circ C$, unless otherwise noted.)

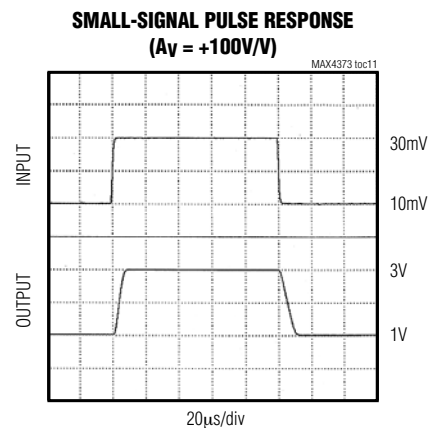
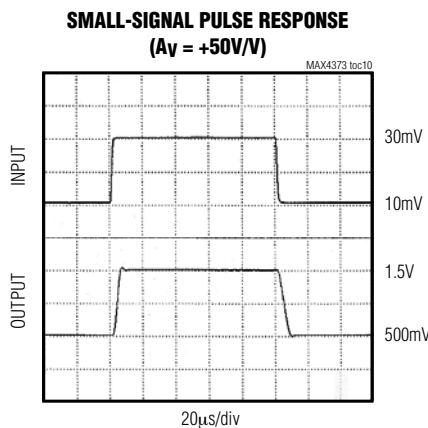
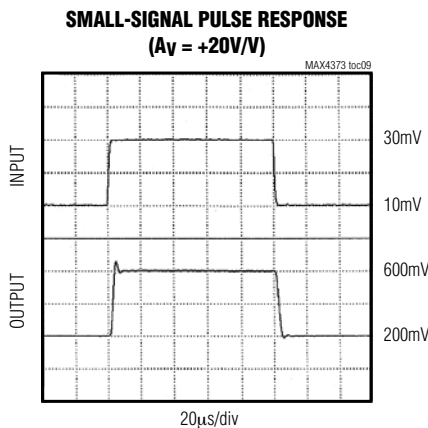
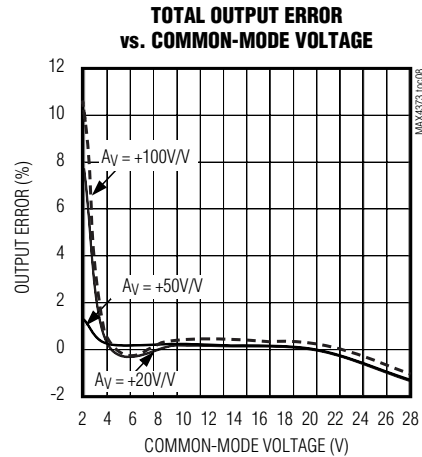
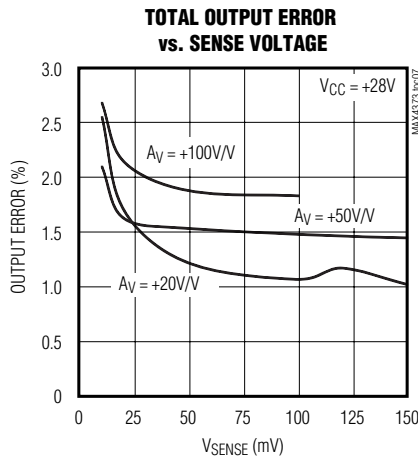
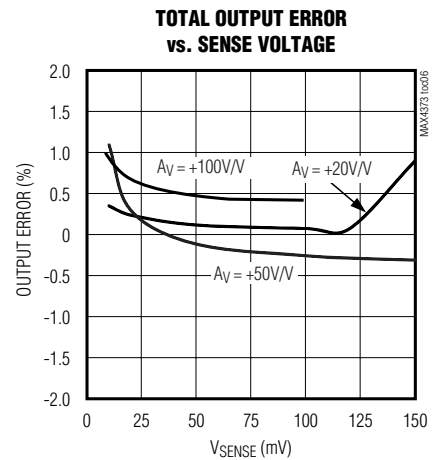
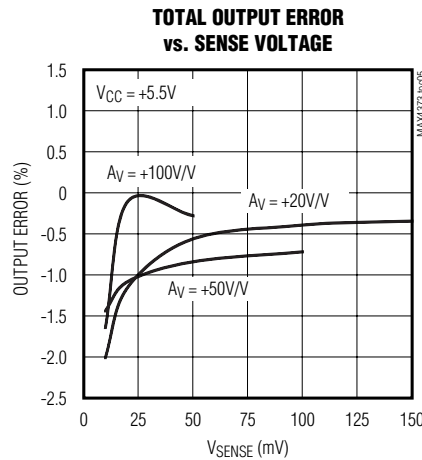
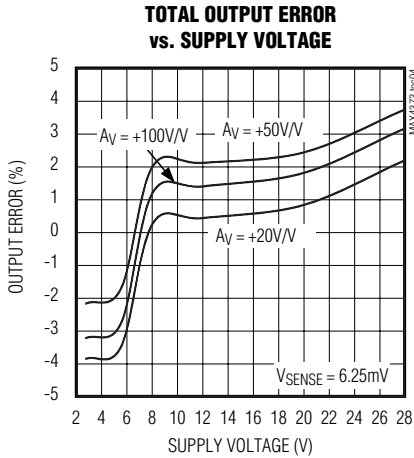

Typical Operating Characteristics (continued)

($V_{RS+} = +12V$, $V_{CC} = +12V$, $R_{LOAD} = 1M\Omega$, $V_{RESET} = 0V$, $V_{SENSE} = 100mV$, $V_{PULL-UP} = +5V$, $R_{PULL-UP} = 10k\Omega$, $T_A = +25^\circ C$, unless otherwise noted.)

LARGE-SIGNAL PULSE RESPONSE
($A_V = +20V/V$)

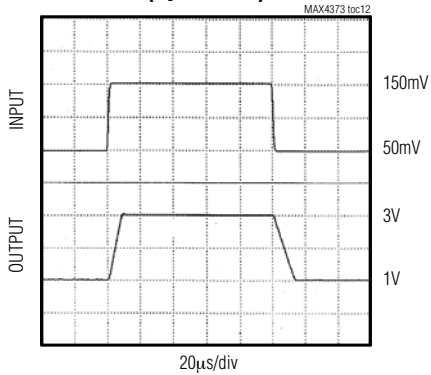

LARGE-SIGNAL PULSE RESPONSE
($A_V = +50V/V$)

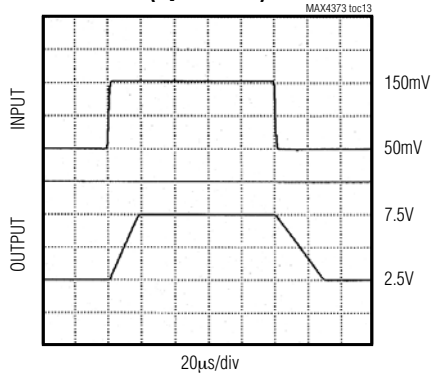

LARGE-SIGNAL PULSE RESPONSE
($A_V = +100V/V$)

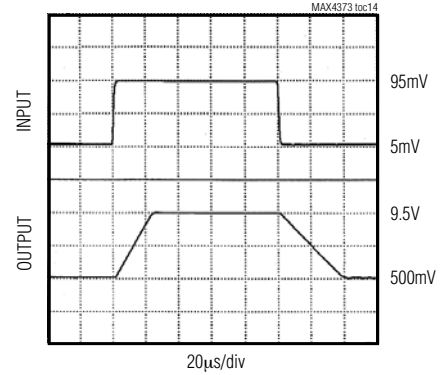

COMMON-MODE REJECTION
vs. FREQUENCY

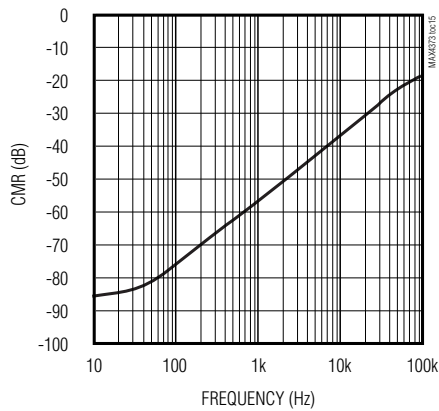

POWER-SUPPLY REJECTION
vs. FREQUENCY

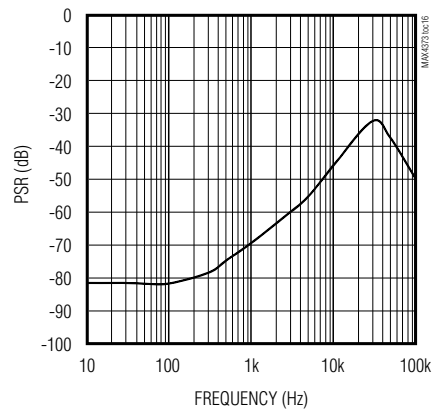

SMALL-SIGNAL GAIN
vs. FREQUENCY

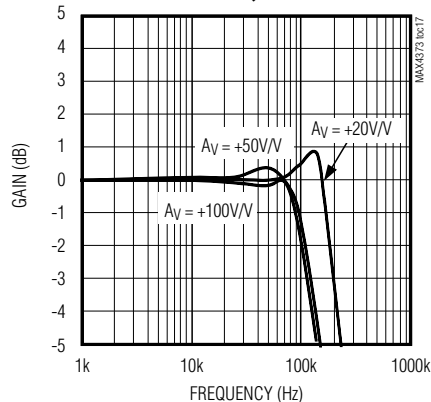

LARGE-SIGNAL GAIN
vs. FREQUENCY

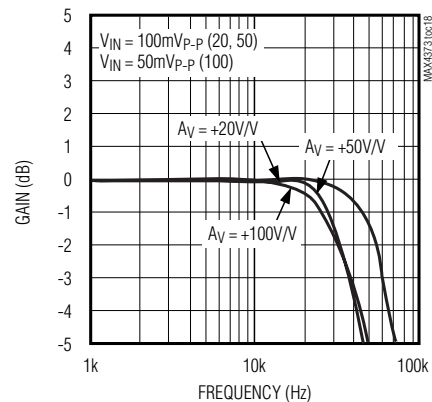

Typical Operating Characteristics (continued)

($V_{RS+} = +12V$, $V_{CC} = +12V$, $R_{LOAD} = 1M\Omega$, $V_{RESET} = 0V$, $V_{SENSE} = 100mV$, $V_{PULL-UP} = +5V$, $R_{PULL-UP} = 10k\Omega$, $T_A = +25^\circ C$, unless otherwise noted.)

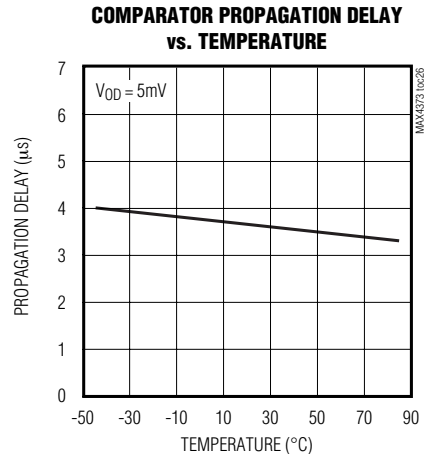
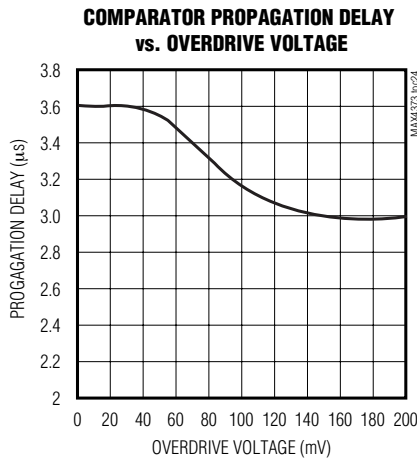
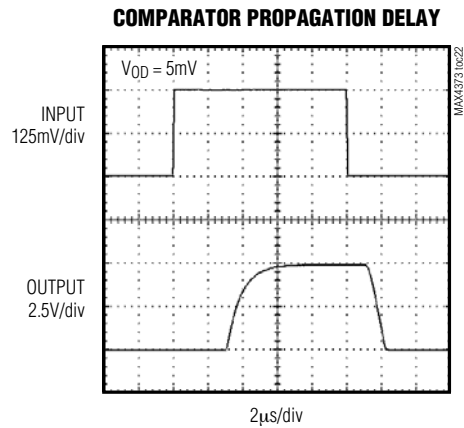
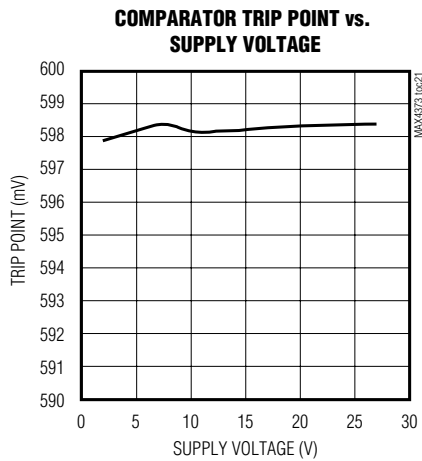
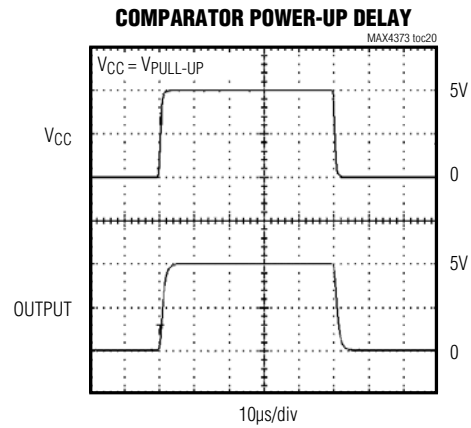
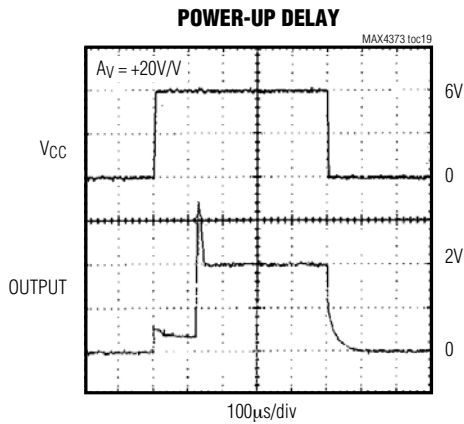

Typical Operating Characteristics (continued)

($V_{RS+} = +12V$, $V_{CC} = +12V$, $R_{LOAD} = 1M\Omega$, $V_{RESET} = 0V$, $V_{SENSE} = 100mV$, $V_{PULL-UP} = +5V$, $R_{PULL-UP} = 10k\Omega$, $T_A = +25^\circ C$, unless otherwise noted.) otherwise noted.)

COMPARATOR RESET VOLTAGE vs. SUPPLY VOLTAGE

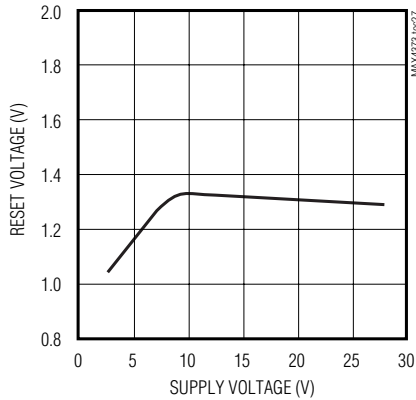

COMPARATOR V_{OL} vs. I_{SINK}

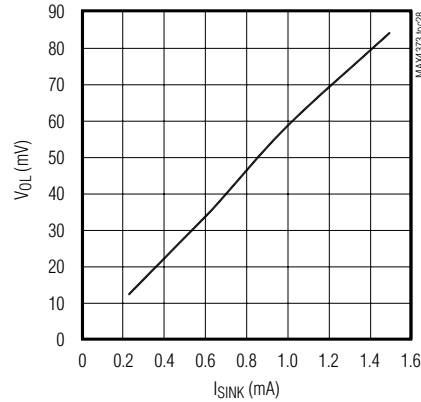

COMPARATOR AC RESPONSE

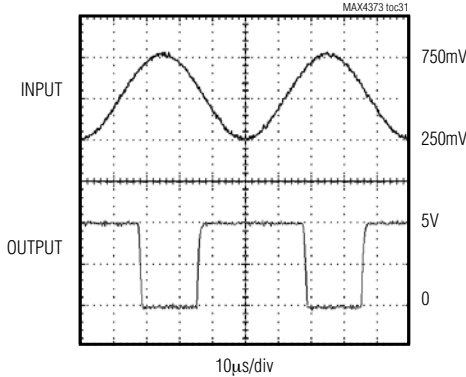

SUPPLY CURRENT vs. TEMPERATURE

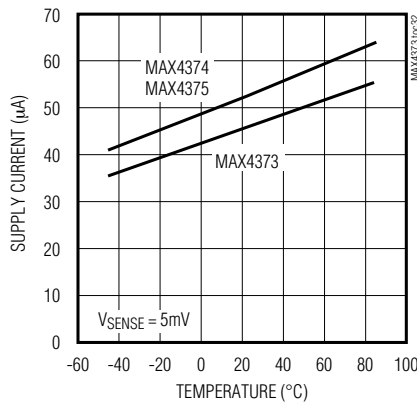

TOTAL OUTPUT ERROR vs. TEMPERATURE

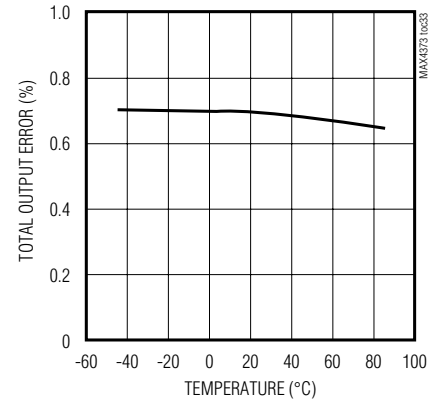

GAIN ACCURACY vs. TEMPERATURE

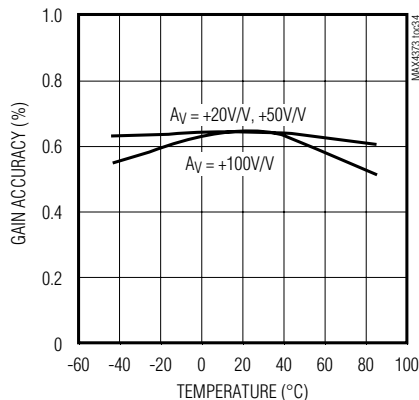

COMPARATOR TRIP POINT vs. TEMPERATURE

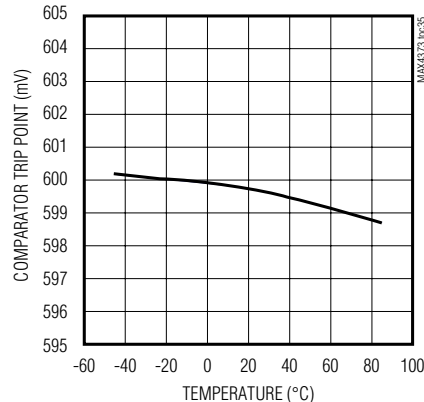

Pin Description

PIN			NAME	FUNCTION
MAX4373	MAX4374/MAX4375			
μ MAX/SO	μ MAX	SO		
1	1	1	V _{CC}	Supply Voltage Input
2	2	2	OUT	Voltage Output. V _{OUT} is proportional to V _{SENSE} (V _{RS+} - V _{RS-}).
3	3	4	CIN1	Comparator Input 1. Positive input of an internal comparator. The negative terminal is connected to a 0.6V internal reference.
—	4	5	CIN2	Comparator Input 2. Terminal of a second internal comparator. The positive terminal for the MAX4374 and the negative terminal for the MAX4375. The other terminal is connected to a 0.6V internal reference.
4	5	7	GND	Ground
5	6	8	$\overline{\text{RESET}}$	Reset Input. Resets the output latch of the comparator at CIN1.
6	8	11	COUT1	Open-Drain Comparator Output. Latching output of the comparator controlled by CIN1. Connect $\overline{\text{RESET}}$ to GND to disable the latch.
—	7	10	COUT2	Open-Drain Comparator Output. Output of the second unlatched internal comparator.
7	9	13	RS-	Load-Side Connection for the External Sense Resistor
8	10	14	RS+	Power Connection to the External Sense Resistor
—	—	3, 6, 9, 12	N.C.	No Connection. Not internally connected.

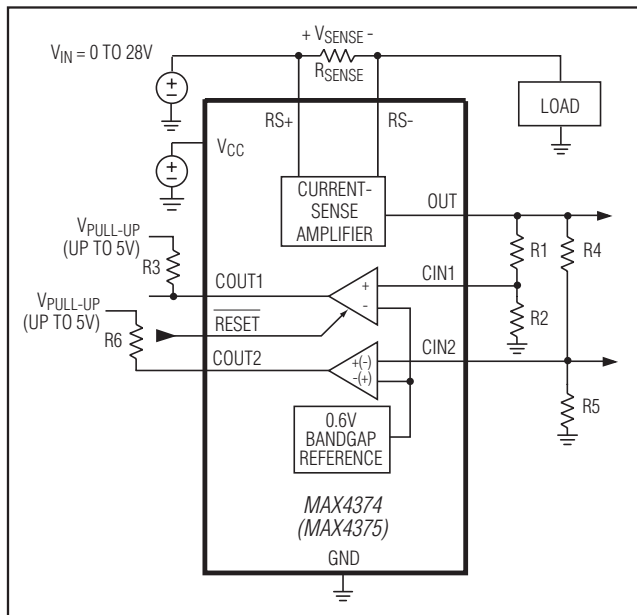

Figure 1. Functional Diagram

Detailed Description

The MAX4373 high-side current-sense supervisor features a high-side current-sense amplifier, bandgap reference, and comparator with latching output to monitor a supply for an overcurrent condition (Figure 1). The latching output allows the comparator to shut down a power supply without oscillations. The MAX4374/MAX4375 offer an additional comparator to allow window detection of the current.

Current-Sense Amplifier

The internal current-sense amplifier features a 0V to +28V input common-mode range that is independent of the supply voltage. With this feature, the device can monitor the output current of a battery in deep discharge and also high-side current-sensing voltages exceeding V_{CC}.

The current-sense amplifier is also suitable for low-side current sensing. However, the total output voltage error will increase when V_{RS+} falls below 2V, as shown in the *Electrical Characteristics* and *Typical Operating Characteristics*.

MAX4373/MAX4374/MAX4375

Low-Cost, Micropower, High-Side Current-Sense Amplifier + Comparator + Reference ICs

Internal Comparator(s)

The MAX4373/MAX4374/MAX4375 contain an open-drain output comparator for current limiting. The comparator's negative terminal is connected to the internal 600mV reference. The positive terminal is accessible at CIN1. When $\overline{\text{RESET}}$ is high, the internal latch is active, and once CIN1 rises above 600mV, the output latches into the open state. Pulsing $\overline{\text{RESET}}$ low for 1.5 μs resets the latch, and holding $\overline{\text{RESET}}$ low makes the latch transparent. See *RESET at Power-Up* section

The MAX4374/MAX4375 contain an additional open-drain comparator. The negative terminal of the MAX4374's additional comparator and the positive terminal of the MAX4375's additional comparator are connected to the internal 600mV reference as shown in Figure 1. The positive terminal of the MAX4374's additional comparator and the negative terminal of the MAX4375's additional comparator are accessible at CIN2.

Applications Information

Recommended Component Values

Ideally, the maximum load current will develop the full-scale sense voltage across the current-sense resistor.

$$V_{\text{OUT}} = V_{\text{SENSE}} \times A_V$$

Choose the gain version needed to yield the maximum output voltage required for the application:

where V_{SENSE} is the full-scale sense voltage, 150mV for gains of +20V/V and +50V/V or 100mV for a gain of +100V/V. A_V is the gain of the device. The minimum supply voltage is $V_{\text{OUT}} + 0.25\text{V}$. Note that the output for the gain of +100V/V is internally clamped at 12V.

$$R_{\text{SENSE(MAX)}} = \frac{V_{\text{SENSE(MAX)}}}{I_{\text{LOAD}}}$$

Calculate the maximum value for R_{SENSE} so that the differential voltage across RS+ and RS- does not exceed the full-scale sense voltage:

Choose the highest value resistance possible to maximize V_{SENSE} and thus minimize total output error.

In applications monitoring high current, ensure that R_{SENSE} is able to dissipate its own I^2R loss. If the resistor's power dissipation is exceeded, its value may drift or it may fail altogether, causing a differential voltage across the terminals in excess of the absolute maximum ratings. Use resistors specified for current-sensing applications.

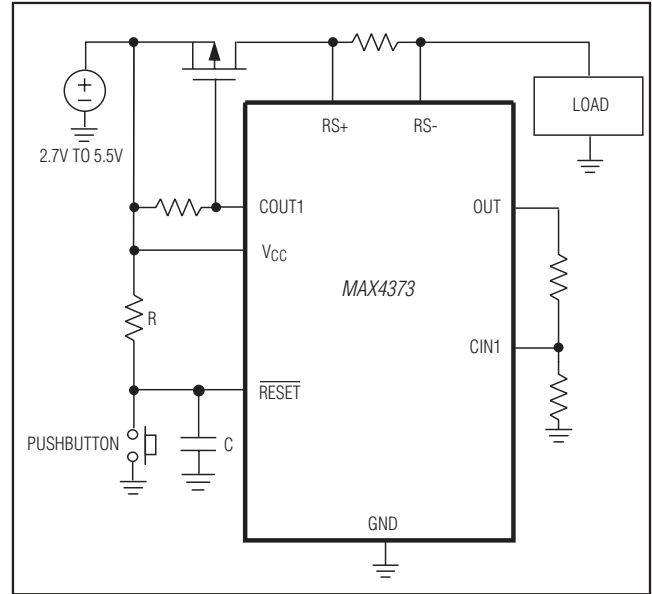

Figure 2. MAX4373 Overcurrent Protection Circuit

Overcurrent Protection Circuit

The overcurrent protection circuit, shown in Figure 2, uses the MAX4373 to control an external P-channel MOSFET. The MOSFET controlled by the MAX4373 opens the current path under overload conditions. The latched output of the MAX4373's comparator prevents the circuit from oscillating, and the pushbutton resets the current path after an overcurrent condition.

Window Detection Circuit

Figure 3 shows a simple circuit suitable for window detection. Let I_{OVER} be the minimum load current

$$I_{\text{UNDER}} = \frac{V_{\text{REF}}}{R_{\text{SENSE}} \times A_V} \left(\frac{R_4 + R_5}{R_5} \right)$$

and

$$I_{\text{OVER}} = \frac{V_{\text{REF}}}{R_{\text{SENSE}} \times A_V} \left(\frac{R_1 + R_2}{R_2} \right)$$

(I_{LOAD}) required to cause a low state at COUT2, and let I_{UNDER} be the maximum load current required to cause a high state at COUT1:

where A_V is the gain of the device and V_{REF} is the internal reference voltage (0.6V typ).

Connect COUT1 and COUT2; the resulting comparator output will be high when the current is inside the current window and low when the current is outside the window. The window is defined as load currents less than I_{OVER} and greater than I_{UNDER} .

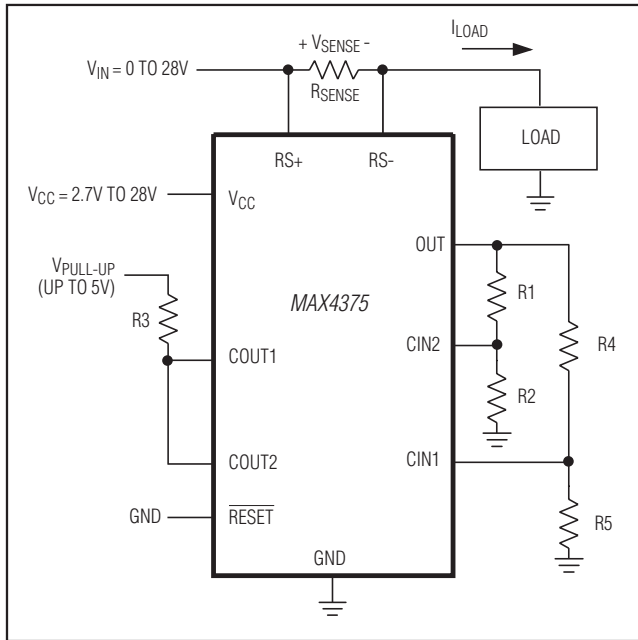

Figure 3. MAX4375 Window Detector

Power-Supply Bypassing

It is recommended that V_{CC} be bypassed to GND with at least a $0.1\mu\text{F}$ ceramic capacitor to isolate the IC from supply voltage transients. It is possible that plugging in/out a battery or AC adapter/charger could cause large, fast line transients ($>5\text{V}/\mu\text{s}$) at V_{CC} . The simplest solution is to run V_{CC} from a better regulated supply (+5V for example), since V_{CC} and $RS+$ (or $RS-$) do not have to be connected together.

For high-speed V_{CC} transients, another solution is to add a resistor in series with the V_{CC} pin and a $0.1\mu\text{F}$ capacitor to create an RC time constant to slow the rise time of the transient. Since these current-sense amplifiers consume less than $100\mu\text{A}$, even a $2.5\text{k}\Omega$ resistor only drops an extra 250mV at V_{CC} . For most applications with fast transients, $1\text{k}\Omega$ in conjunction with a $0.1\mu\text{F}$ bypass capacitor works well.

RESET at Power-Up

The $\overline{\text{RESET}}$ pin is used to control the latch function of comparator 1. Holding $\overline{\text{RESET}}$ low ($<0.8\text{V}$) makes the latch transparent and COUT1 will respond to changes at CIN1 , above and below the internal 600mV reference threshold voltage. When $\overline{\text{RESET}}$ is high ($>2.0\text{V}$), once CIN1 rises above 600mV , COUT1 latches into the open-drain OFF state and remains in this state even if CIN1 drops below 600mV . Pulsing $\overline{\text{RESET}}$ low for at least $1.5\mu\text{s}$ resets the latch.

There is no internal circuitry to control the reset function during power-up. To prevent false latching, $\overline{\text{RESET}}$ must be held low until the V_{CC} power has risen above the 2.7V minimum operating supply voltage. This is easily accomplished when $\overline{\text{RESET}}$ is driven under μC or logic gate control. However, if $\overline{\text{RESET}}$ is to be always connected high, add an RC between V_{CC} , $\overline{\text{RESET}}$ and GND (see Figure 2). Note that $\overline{\text{RESET}}$ cannot exceed $V_{CC} + 0.3\text{V}$ or $+12\text{V}$, whichever is less.

The following formula can be used to determine the appropriate RC value.

$$RC = \frac{T}{\ln(2.7\text{V}/(2.7\text{V} - 0.8\text{V}))} = \frac{T}{0.3514}$$

where T is the maximum time for V_{CC} to reach 2.7V and 0.8V is the maximum $\overline{\text{RESET}}$ logic low voltage. For example, a $470\text{k}\Omega$ resistor and $0.22\mu\text{F}$ capacitor will keep $\overline{\text{RESET}}$ low during a power-up time of up to 36ms . A faster power-up time is also safe with the calculated R and C since the capacitor will have even less time to charge.

Pin Configurations

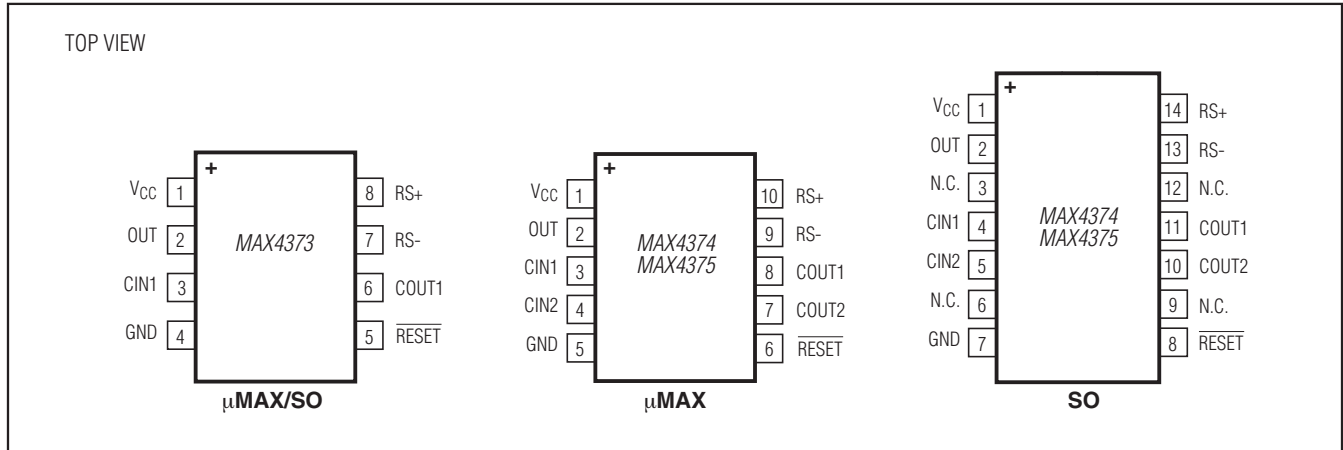

Ordering Information (continued)

PART	TEMP RANGE	PIN-PACKAGE	GAIN (V/V)
MAX4374 TEUB+	-40°C to +85°C	10 µMAX	+20
MAX4374TESD+	-40°C to +85°C	14 SO	+20
MAX4374FEUB+	-40°C to +85°C	10 µMAX	+50
MAX4374FESD+	-40°C to +85°C	14 SO	+50
MAX4374HEUB+	-40°C to +85°C	10 µMAX	+100
MAX4374HESD+	-40°C to +85°C	14 SO	+100
MAX4375 TEUB+	-40°C to +85°C	10 µMAX	+20
MAX4375TESD+	-40°C to +85°C	14 SO	+20
MAX4375FEUB+	-40°C to +85°C	10 µMAX	+50
MAX4375FESD+	-40°C to +85°C	14 SO	+50
MAX4375HEUB+	-40°C to +85°C	10 µMAX	+100
MAX4375HESD+	-40°C to +85°C	14 SO	+100

+Denotes a lead(Pb)-free/RoHS-compliant package.

Chip Information

SUBSTRATE CONNECTED TO GND

Package Information

For the latest package outline information and land patterns (footprints), go to www.maximintegrated.com/packages. Note that a "+", "#", or "-" in the package code indicates RoHS status only. Package drawings may show a different suffix character, but the drawing pertains to the package regardless of RoHS status.

PACKAGE TYPE	PACKAGE CODE	OUTLINE NO.	LAND PATTERN NO.
8 SOIC	S8+2	21-0041	90-0096
8 µMAX	U8+1	21-0036	90-0092
10 µMAX	U10+2	21-0061	90-0330
14 SOIC	S14+1	21-0041	90-0096

Revision History

REVISION NUMBER	REVISION DATE	DESCRIPTION	PAGES CHANGED
3	6/10	Clarified 0V to 2V is not a high-accuracy range for the device, added lead-free options and soldering temperature	1, 2, 12
4	1/11	Clarified V_{RS+} conditions in <i>Electrical Characteristics</i> table	2
5	5/15	Added the <i>Benefits and Features</i> section	1

For pricing, delivery, and ordering information, please contact Maxim Direct at 1-888-629-4642, or visit Maxim Integrated's website at www.maximintegrated.com.

Maxim Integrated cannot assume responsibility for use of any circuitry other than circuitry entirely embodied in a Maxim Integrated product. No circuit patent licenses are implied. Maxim Integrated reserves the right to change the circuitry and specifications without notice at any time. The parametric values (min and max limits) shown in the *Electrical Characteristics* table are guaranteed. Other parametric values quoted in this data sheet are provided for guidance.

Mouser Electronics

Authorized Distributor

Click to View Pricing, Inventory, Delivery & Lifecycle Information:

Maxim Integrated:

[MAX4373FEUA+](#) [MAX4373TESA+](#) [MAX4373TEUA+](#) [MAX4375FESD+](#) [MAX4589CAP+T](#) [MAX4373FESA](#)
[MAX4373FESA+](#) [MAX4373FESA+T](#) [MAX4373FEUA](#) [MAX4373FEUA+T](#) [MAX4373HESA](#) [MAX4373HESA+](#)
[MAX4373HESA+T](#) [MAX4373HEUA](#) [MAX4373HEUA+](#) [MAX4373HEUA+T](#) [MAX4373TESA](#) [MAX4373TESA+T](#)
[MAX4373TEUA](#) [MAX4373TEUA+T](#) [MAX4374FESD+](#) [MAX4374FESD+T](#) [MAX4374FEUB+](#) [MAX4374FEUB+T](#)
[MAX4374HESD](#) [MAX4374HESD+](#) [MAX4374HESD+T](#) [MAX4374HEUB](#) [MAX4374HEUB+](#) [MAX4374HEUB+T](#)
[MAX4374TESD](#) [MAX4374TESD+](#) [MAX4374TESD+T](#) [MAX4374TEUB](#) [MAX4374TEUB+](#) [MAX4374TEUB+T](#)
[MAX4375FESD+T](#) [MAX4375FEUB+](#) [MAX4375FEUB+T](#) [MAX4375HESD](#) [MAX4375HESD+](#) [MAX4375HESD+T](#)
[MAX4375HEUB+](#) [MAX4375HEUB+T](#) [MAX4375TESD+T](#) [MAX4375TEUB](#) [MAX4375TEUB+](#) [MAX4375TEUB+T](#)
[MAX4375TESD+](#) [MAX4373FESA-T](#) [MAX4373FEUA-T](#) [MAX4373HESA-T](#) [MAX4373HEUA-T](#) [MAX4373TESA-T](#)
[MAX4373TEUA+TG071](#) [MAX4373TEUA-T](#) [MAX4374HESD-T](#) [MAX4374HEUB-T](#) [MAX4374TESD-T](#) [MAX4374TEUB-](#)
[T](#) [MAX4375HESD-T](#) [MAX4375TEUB-T](#)