

Dual-Supply, Low-On-Resistance, SPST, CMOS Analog Switches

ABSOLUTE MAXIMUM RATINGS

(Voltages Referenced to V-)

| | | | |
|--|----------------------|---|-----------------|
| V+ | -0.3V, +13V | 5-Pin SOT23-5 (derate 7.1mW/°C above +70°C) | 571mW |
| Voltage into Any Terminal (Note 1) | | 8-Pin CERDIP (derate 8.00mW/°C above +70°C) | 640mW |
| or ±20mA (whichever occurs first) | -0.3V to (V+ + 0.3V) | Operating Temperature Ranges | |
| Continuous Current into Any Terminal | ±20mA | MAX4516C_/MAX4517_ | 0°C to +70°C |
| Peak Current, NO, NC, or COM_ | ±30mA | MAX4516E_/MAX4517E_ | -40°C to +85°C |
| (pulsed at 1ms, 10% duty cycle) | | MAX4516MJA/MAX4517MJA | -55°C to +125°C |
| ESD per Method 3015.7 | >2000V | Storage Temperature Range | -65°C to +150°C |
| Continuous Power Dissipation (T _A = +70°C) | | Lead Temperature (soldering, 10sec) | +300°C |
| 8-Pin Plastic DIP (derate 9.09mW/°C above +70°C) | 727mW | | |
| 8-Pin SO (derate 5.88mW/°C above +70°C) | 471mW | | |

Note 1: Voltages exceeding V+ or V- on any signal terminal are clamped by internal diodes. Limit forward-diode current to maximum current rating.

Stresses beyond those listed under "Absolute Maximum Ratings" may cause permanent damage to the device. These are stress ratings only, and functional operation of the device at these or any other conditions beyond those indicated in the operational sections of the specifications is not implied. Exposure to absolute maximum rating conditions for extended periods may affect device reliability.

ELECTRICAL CHARACTERISTICS—±5V Supply

(V+ = +4.5V to +5.5V, V- = -4.5V to -5.5V, V_{INH} = 3.5V, V_{INL} = 1.5V, T_A = T_{MIN} to T_{MAX}, unless otherwise noted. Typical values are at T_A = +25°C.)

| PARAMETER | SYMBOL | CONDITIONS | MIN | TYP (Note 2) | MAX | UNITS | |
|--|--|---|---|-----------------|-----------|-------|----|
| ANALOG SWITCH | | | | | | | |
| Analog Signal Range | V _{COM} , V _{NO} , V _{NC} | | V- | | V+ | V | |
| COM to NO or NC On-Resistance | R _{ON} | V+ = 5V, V- = -5V, V _{NO} or V _{NC} = 3V, I _{COM} = 1mA | T _A = +25°C | | 10 | 20 | Ω |
| | | | T _A = T _{MIN} to T _{MAX} | | | 25 | |
| COM to NO or NC On-Resistance Flatness | R _{FLAT(ON)} | V+ = 5V, V- = -5V; V _{NO} or V _{NC} = 3V, 0V, -3V; I _{COM} = 1mA | T _A = +25°C | | 2 | 4 | Ω |
| | | | T _A = T _{MIN} to T _{MAX} | | | 6 | |
| NO or NC Off-Leakage Current (Note 3) | I _{NO(OFF)} I _{NC(OFF)} | V+ = 5.5V, V- = 5.5V, V _{COM} = ±4.5V, V _{NO} or V _{NC} = ∓4.5V | T _A = +25°C | | -1 | 0.01 | nA |
| | | | T _A = T _{MIN} to T _{MAX} | C, E | -20 | 20 | |
| | | | | M | -100 | 100 | |
| COM Off-Leakage Current (Note 3) | I _{COM(OFF)} | V+ = 5.5V, V- = -5.5V, V _{COM} = ±4.5V, V _{NO} or V _{NC} = ∓4.5V | T _A = +25°C | | -1 | 0.01 | nA |
| | | | T _A = T _{MIN} to T _{MAX} | C, E | -20 | 20 | |
| | | | | M | -100 | 100 | |
| COM On-Leakage Current (Note 3) | I _{COM(ON)} | V+ = 5.5V, V- = -5.5V, V _{COM} = ±4.5V, V _{NO} or V _{NC} = ±4.5V | T _A = +25°C | | -2 | 0.01 | nA |
| | | | T _A = T _{MIN} to T _{MAX} | C, E | -40 | 40 | |
| | | | | M | -200 | 200 | |
| DIGITAL I/O | | | | | | | |
| Input Logic High | V _{IH} | | V+ - 1.5V | | V+ | V | |
| Input Logic Low | V _{IL} | | V- | | V+ - 3.5V | V | |
| Input Current Logic High or Low | I _{IH} , I _{IL} | V _{IN} = V+, 0V | -0.5 | 0.03 | 0.5 | μA | |

Dual-Supply, Low-On-Resistance, SPST, CMOS Analog Switches

MAX4516/MAX4517

ELECTRICAL CHARACTERISTICS—±5V Supply (continued)

(V+ = +4.5V to +5.5V, V- = -4.5V to -5.5V, VINH = 3.5V, VINL = 1.5V, TA = TMIN to TMAX, unless otherwise noted. Typical values are at TA = +25°C.)

| PARAMETER | SYMBOL | CONDITIONS | MIN | TYP (Note 2) | MAX | UNITS |
|---------------------------------------|----------------------|---|-------------------|-----------------|-----|-------|
| SWITCH DYNAMIC CHARACTERISTICS | | | | | | |
| Turn-On Time | tON | Figure 1 | TA = +25°C | 40 | 100 | ns |
| | | | TA = TMIN to TMAX | | 150 | |
| Turn-Off Time | tOFF | Figure 1 | TA = +25°C | 30 | 75 | ns |
| | | | TA = TMIN to TMAX | | 125 | |
| Charge Injection (Note 4) | Q | CL = 1nF, VNO = 0V, RS = 0Ω, TA = +25°C, Figure 2 | | 10 | 20 | pC |
| Off Isolation | VISO | RL = 50Ω, CL = 15pF, VNO = 1VRMS, f = 100kHz, TA = +25°C, Figure 3 | | -86 | | dB |
| NO or NC Off Capacitance | CNO(OFF), CNO(ON) | f = 1MHz, TA = +25°C, Figure 4 | | 9 | | pF |
| COM Off Capacitance | CCOM(OFF) | f = 1MHz, TA = +25°C, Figure 4 | | 9 | | pF |
| COM On Capacitance | CCOM(ON) | f = 1MHz, TA = +25°C, Figure 4 | | 22 | | pF |
| POWER SUPPLY | | | | | | |
| Power-Supply Range | | | ±1 | | ±6 | V |
| V+ Supply Current | I+ | VIN = 0V or V+ | TA = +25°C | 40 | 125 | μA |
| | | | TA = TMIN to TMAX | | 200 | |
| V- Supply Current | I- | VIN = 0V or V+ | TA = +25°C | -125 | -30 | μA |
| | | | TA = TMIN to TMAX | 200 | | |

Note 2: The algebraic convention is used in this data sheet; the most negative value is shown in the minimum column.

Note 3: Leakage parameters are 100% tested at maximum-rated hot operating temperature, and are guaranteed by correlation at +25°C.

Note 4: Guaranteed, not production tested.

Note 5: SOT packaged parts are 100% tested at +25°C. Limits at maximum and minimum rated temperature are guaranteed by design and correlation limits at +25°C.

Dual-Supply, Low-On-Resistance, SPST, CMOS Analog Switches

Typical Operating Characteristics

($V_+ = +5V$, $V_- = -5V$, $T_A = +25^\circ C$, unless otherwise noted.)

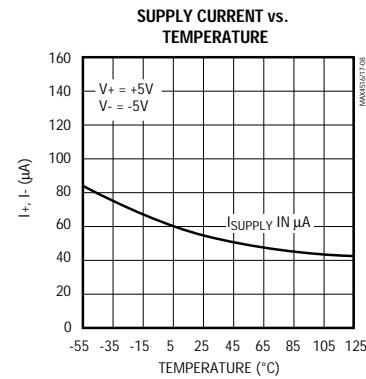
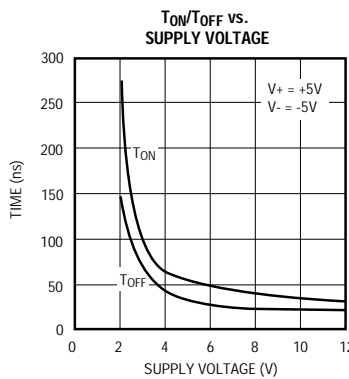
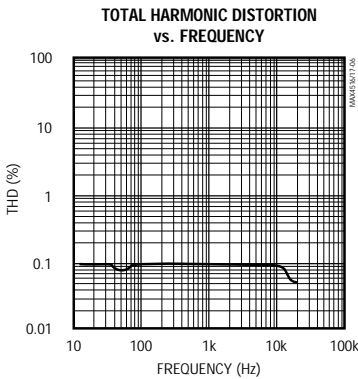
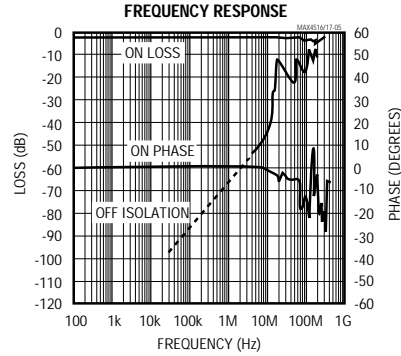
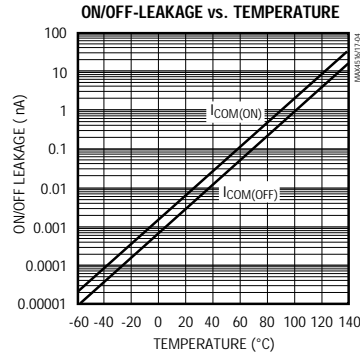
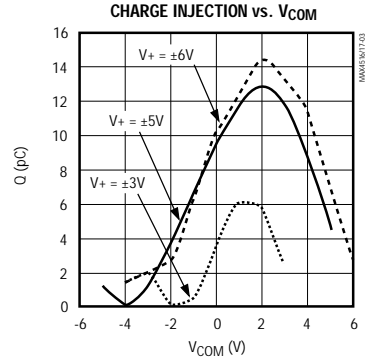
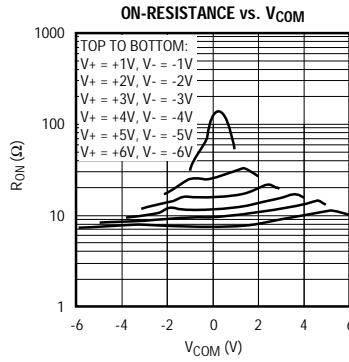
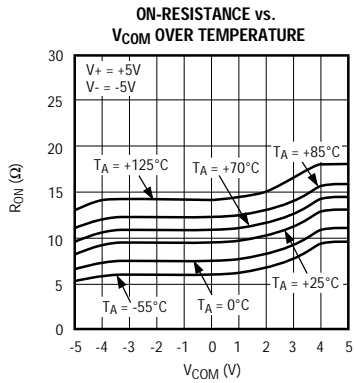

Dual-Supply, Low-On-Resistance, SPST, CMOS Analog Switches

Pin Description

MAX4516/MAX4517

| PIN | | | | NAME | FUNCTION |
|---------|---------|---------|---------|------|--|
| MAX4516 | | MAX4517 | | | |
| DIP/SO | SOT23-5 | DIP/SO | SOT23-5 | | |
| 1 | 1 | 1 | 1 | COM | Analog Switch Common Terminal |
| 2, 3, 5 | — | 2, 3, 5 | — | N.C. | No Connect (not internally connected) |
| 4 | 5 | 4 | 5 | V+ | Positive Supply-Voltage Input (analog and digital) |
| 6 | 4 | 6 | 4 | IN | Digital Control Input |
| 7 | 3 | 7 | 3 | V- | Negative Supply-Voltage Input (analog and digital) |
| 8 | 2 | — | — | NO | Analog Switch (normally open) |
| — | — | 8 | 2 | NC | Analog Switch (normally closed) |

Note: NO, NC, and COM pins are identical and interchangeable. Any may be considered as an input or an output; signals pass equally well in both directions.

Applications Information

Power-Supply Considerations

The MAX4516/MAX4517 operate with power-supply voltages from $\pm 1\text{V}$ to $\pm 6\text{V}$, but are tested and guaranteed only with $\pm 5\text{V}$ supplies. Similarly, they will operate with a single $+2\text{V}$ to $+12\text{V}$ supply, but logic-level inputs can shift with higher voltages. The pin-compatible MAX4514/MAX4515 are recommended for use with a single supply.

The MAX4516/MAX4517 construction is typical of most CMOS analog switches, except that they have only two supply pins: V+ and V-. V+ and V- drive the internal CMOS switches and set their analog voltage limits. Reverse ESD-protection diodes are internally connected between each analog-signal pin and both V+ and V-. One of these diodes conducts if any analog signal exceeds V+ or V-.

Virtually all the analog leakage current comes from the ESD diodes to V+ or V-. Although the ESD diodes on a given signal pin are identical and therefore fairly well balanced, they are reverse biased differently. Each is biased by either V+ or V- and the analog signal. This means their leakages will vary as the signal varies. The difference in the two diode leakages to the V+ and V- pins constitutes the analog-signal-path leakage current. All analog leakage current flows between each pin and one of the supply terminals, not to the other switch terminal. This is why both sides of a given switch can show leakage currents of the same or opposite polarity.

There is no connection between the analog-signal paths and V+ or V-.

V+ and V- also power the internal logic and logic-level translators. The logic-level translators convert the logic levels to switched V+ and V- signals to drive the analog signal gates.

Logic-Level Thresholds

The logic-level thresholds are CMOS-compatible but **not TTL-compatible**. Since these parts have no ground pin, the logic-level threshold is referenced to V+. The threshold limits are $V+ = -1.5\text{V}$ and $V+ = -3.5\text{V}$ for V+ levels between $+6\text{V}$ and $+3\text{V}$. When $V+ = +2\text{V}$, the logic threshold is approximately 0.6V .

Do not connect the MAX4516/MAX4517's V+ to +3V and then connect the logic-level pins to logic-level signals that operate from a +5V supply. TTL levels can exceed +3V and violate the absolute maximum ratings, damaging the part and/or external circuits.

High-Frequency Performance

In 50Ω systems, signal response is reasonably flat up to 250MHz (see *Typical Operating Characteristics*). Above 20MHz , the on response has several minor peaks that are highly layout dependent. The problem is not in turning the switch on; it's in turning it off. The off-state switch acts like a capacitor and passes higher frequencies with less attenuation. At 10MHz , off isolation is about -48dB in 50Ω systems, decreasing (approximately 20dB per decade) as frequency increases. Higher circuit impedances also cause off isolation to decrease. Off isolation is about 3dB above that of a bare IC socket, and is due entirely to capacitive coupling.

Dual-Supply, Low-On-Resistance, SPST, CMOS Analog Switches

Test Circuits/Timing Diagrams

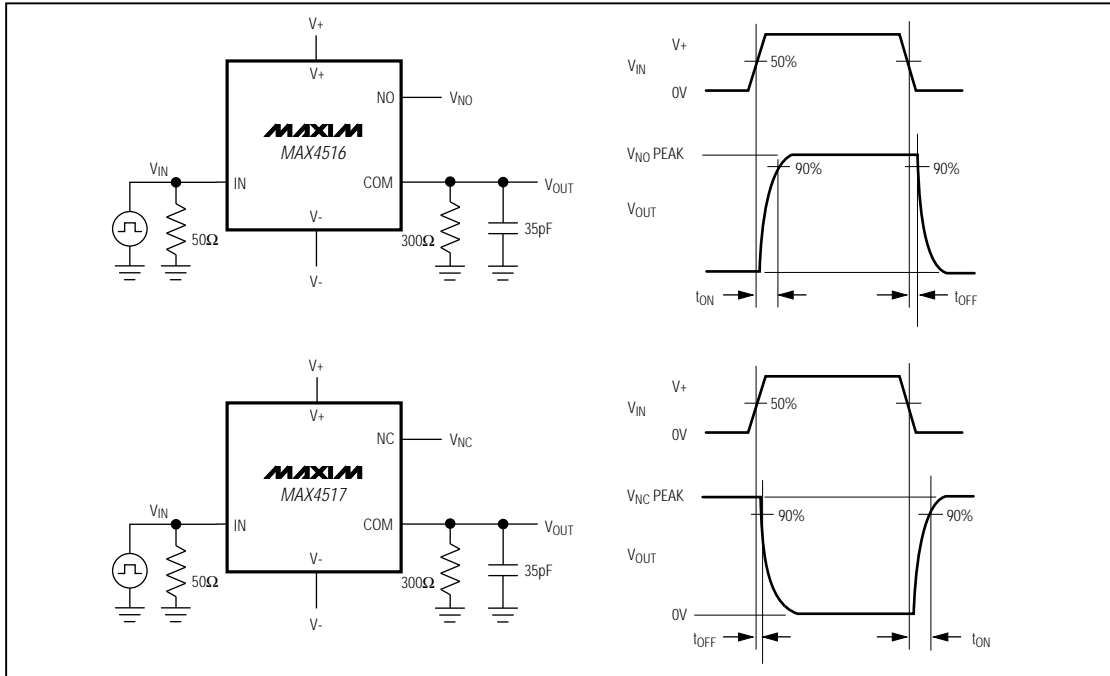

Figure 1. Switching Times

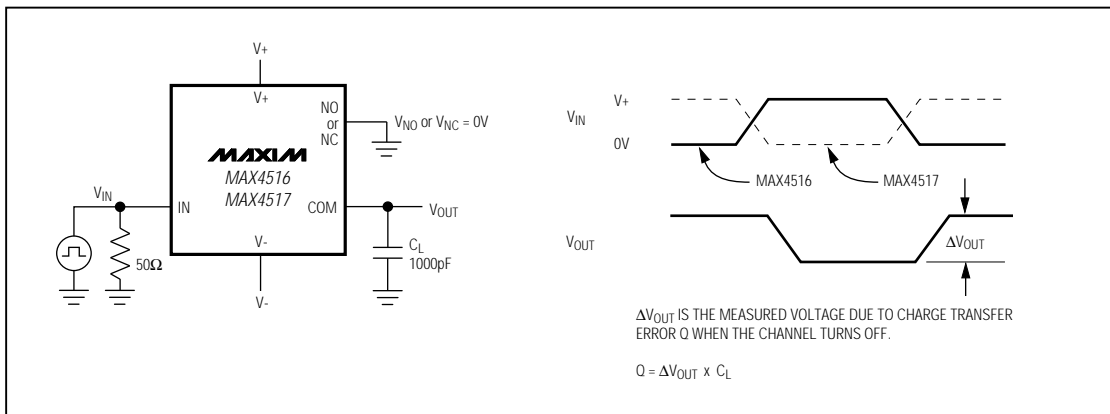

Figure 2. Charge Injection

Dual-Supply, Low-On-Resistance, SPST, CMOS Analog Switches

Test Circuits/Timing Diagrams (continued)

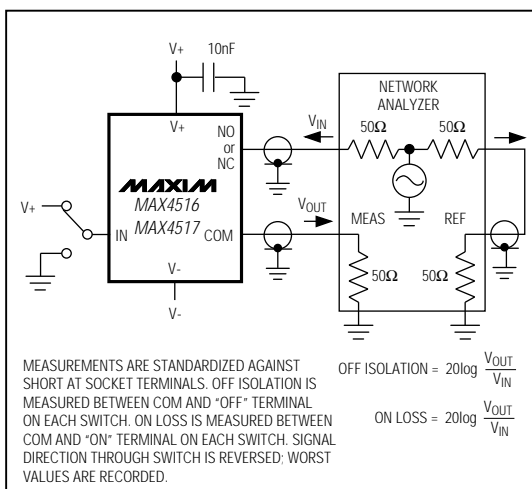

Figure 3. Off Isolation, On Loss, and Crosstalk

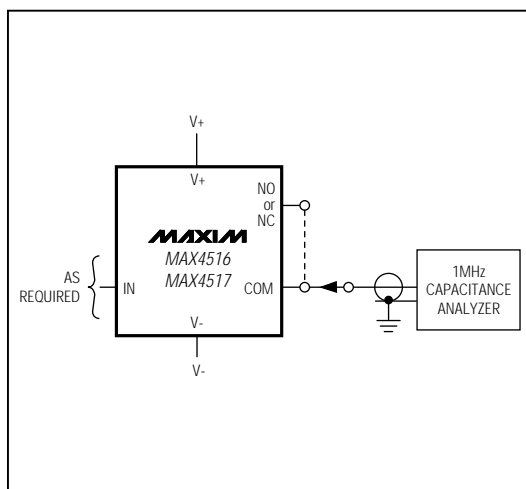

Figure 4. NO, NC, and COM Capacitance

MAX4516/MAX4517

Chip Topography

Ordering Information (continued)

| PART | TEMP. RANGE | PIN-PACKAGE |
|-------------------|-----------------|---------------|
| MAX4516EPA | -40°C to +85°C | 8 Plastic DIP |
| MAX4516ESA | -40°C to +85°C | 8 SO |
| MAX4516EUK | -40°C to +85°C | 5 SOT23-5 |
| MAX4516MJA | -55°C to +125°C | 8 CERDIP** |
| MAX4517CPA | 0°C to +70°C | 8 Plastic DIP |
| MAX4517CSA | 0°C to +70°C | 8 SO |
| MAX4517CUK | 0°C to +70°C | 5 SOT23-5 |
| MAX4517C/D | 0°C to +70°C | Dice* |
| MAX4517EPA | -40°C to +85°C | 8 Plastic DIP |
| MAX4517ESA | -40°C to +85°C | 8 SO |
| MAX4517EUK | -40°C to +85°C | 5 SOT23-5 |
| MAX4517MJA | -55°C to +125°C | 8 CERDIP** |

*Contact factory for dice specifications.

**Contact factory for availability.

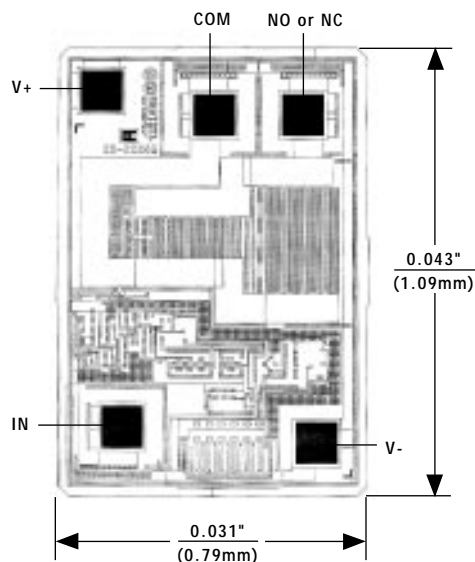

TRANSISTOR COUNT: 36
SUBSTRATE IS INTERNALLY CONNECTED TO V+

MAX4516/MAX4517

Dual-Supply, Low-On-Resistance, SPST, CMOS Analog Switches

Tape-and-Reel Information

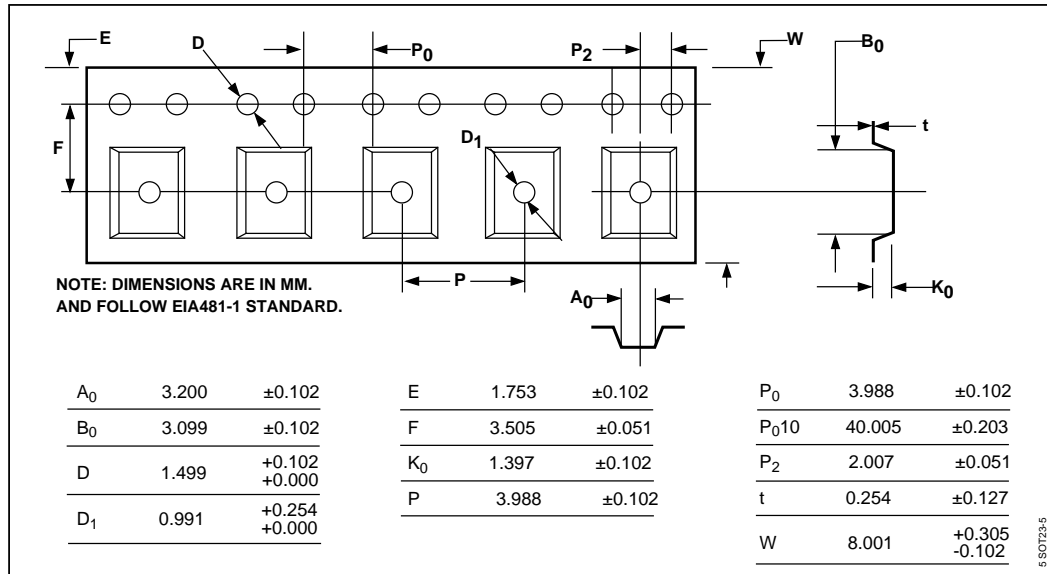

Package Information

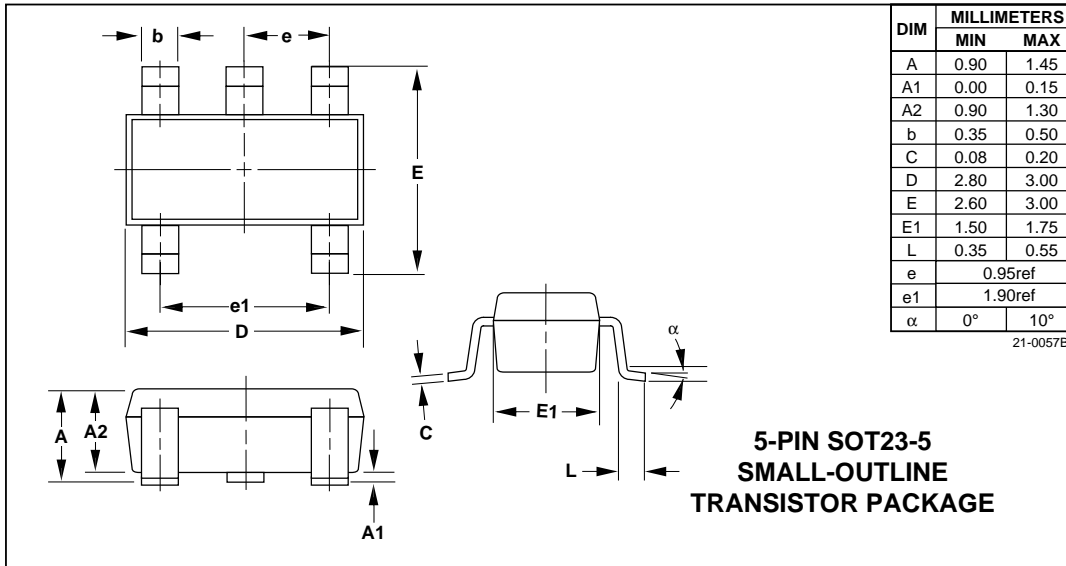

Maxim cannot assume responsibility for use of any circuitry other than circuitry entirely embodied in a Maxim product. No circuit patent licenses are implied. Maxim reserves the right to change the circuitry and specifications without notice at any time.

8 Maxim Integrated Products, 120 San Gabriel Drive, Sunnyvale, CA 94086 (408) 737-7600

© 1996 Maxim Integrated Products

Printed USA

MAXIM is a registered trademark of Maxim Integrated Products.

Mouser Electronics

Authorized Distributor

Click to View Pricing, Inventory, Delivery & Lifecycle Information:

Maxim Integrated:

[MAX4516CUK+T](#) [MAX4516CPA+](#) [MAX4516CSA+](#) [MAX4516CSA+T](#) [MAX4516EUK+T](#) [MAX4516EUK-T](#)
[MAX4517CUK+T](#) [MAX4517EUK+T](#)