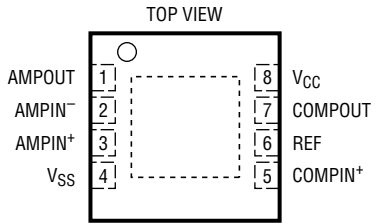
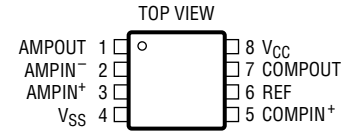
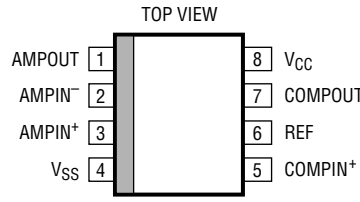
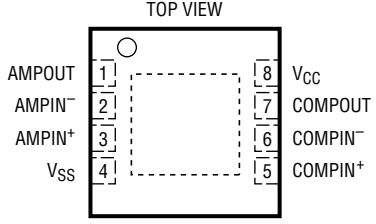
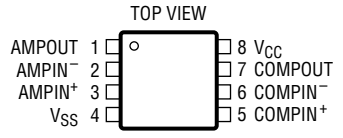
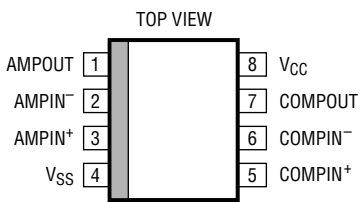

# LTC1541/LTC1542

## ABSOLUTE MAXIMUM RATINGS (Note 1)

Supply Voltage .....	13V	Operating Temperature Range (Note 7) ..	-40°C to 85°C
Input Voltage .....	-0.3V to 13V	Specified Temperature Range (Note 8) ...	-40°C to 85°C
Output Voltage .....	-0.3V to 13V	Lead Temperature (Soldering, 10 sec) .....	300°C
Output Short-Circuit Duration .....	Indefinite		
Storage Temperature Range .....	-65°C to 150°C		
(DD Package) .....	-65°C to 125°C		

## PACKAGE/ORDER INFORMATION

 <p>DD PACKAGE 8-LEAD (3mm x 3mm) PLASTIC DFN T<sub>JMAX</sub> = 125°C, θ<sub>JA</sub> = 160°C/W (NOTE 6) UNDERSIDE METAL CONNECTED TO V<sup>-</sup> (PCB CONNECTION OPTIONAL)</p>		 <p>MS8 PACKAGE 8-LEAD PLASTIC MSOP T<sub>JMAX</sub> = 150°C, θ<sub>JA</sub> = 250°C/W</p>		 <p>S8 PACKAGE 8-LEAD PLASTIC SO T<sub>JMAX</sub> = 150°C, θ<sub>JA</sub> = 150°C/W</p>	
ORDER PART NUMBER	DD PART MARKING*	ORDER PART NUMBER	MS8 PART MARKING	ORDER PART NUMBER	S8 PART MARKING
LTC1541CDD LTC1541IDD	LAAT	LTC1541CMS8 LTC1541IMS8	LTBE LTADW	LTC1541CS8 LTC1541IS8	1541 1541I
 <p>DD PACKAGE 8-LEAD (3mm x 3mm) PLASTIC DFN T<sub>JMAX</sub> = 125°C, θ<sub>JA</sub> = 160°C/W (NOTE 6) UNDERSIDE METAL CONNECTED TO V<sup>-</sup> (PCB CONNECTION OPTIONAL)</p>		 <p>MS8 PACKAGE 8-LEAD PLASTIC MSOP T<sub>JMAX</sub> = 150°C, θ<sub>JA</sub> = 250°C/W</p>		 <p>S8 PACKAGE 8-LEAD PLASTIC SO T<sub>JMAX</sub> = 150°C, θ<sub>JA</sub> = 150°C/W</p>	
ORDER PART NUMBER	DD PART MARKING*	ORDER PART NUMBER	MS8 PART MARKING	ORDER PART NUMBER	S8 PART MARKING
LTC1542CDD LTC1542IDD	LAAU	LTC1542CMS8 LTC1542IMS8	LTDE LTADX	LTC1542CS8 LTC1542IS8	1542 1542I
<p><b>Order Options</b> Tape and Reel: Add #TR Lead Free: Add #PBF Lead Free Tape and Reel: Add #TRPBF Lead Free Part Marking: <a href="http://www.linear.com/leadfree/">http://www.linear.com/leadfree/</a></p>					

Consult LTC Marketing for parts specified with wider operating temperature ranges.

\*Temperature grades are identified by a label on the shipping container.

15412fd

## ELECTRICAL CHARACTERISTICS

The ● denotes specifications which apply over the full operating temperature range, otherwise specifications are at  $T_A = 25^\circ\text{C}$ .  $V_{CC} = 5\text{V}$ ,  $V_{SS} = 0\text{V}$ , unless otherwise noted.

SYMBOL	PARAMETER	CONDITIONS	MIN	TYP	MAX	UNITS	
<b>Power Supply</b>							
$V_{CC}$	Supply Voltage Range		●	2.5	12.6	V	
$I_{CC}$	Supply Current (Note 2)			5	10	$\mu\text{A}$	
		Commercial Grade	●		16	$\mu\text{A}$	
		Industrial Grade	●		17	$\mu\text{A}$	
<b>Comparator</b>							
$V_{OS}$	Input Offset Voltage (Note 3)	(SO-8)			1	mV	
		Commercial Grade (SO-8)	●		1.5	mV	
		Industrial Grade (SO-8)	●		2.0	mV	
		(MSOP)(DFN)			1.2	mV	
		Commercial Grade (MSOP)(DFN)	●		2.0	mV	
		Industrial Grade (MSOP)(DFN)	●		2.5	mV	
$V_{TRIP}$	Trip Point (Note 4)		●	1.7 1	2.25 2.8 3.8	mV mV	
$I_{IN}$	Input Leakage Current (Note 5)		●	0.01	1	nA	
$V_{CM}$	Input Common Mode Range		●	$V_{SS}$	$V_{CC} - 1.3\text{V}$	V	
CMRR	Common Mode Rejection Ratio	$V_{CM} = V_{SS}$ to $(V_{CC} - 1.3\text{V})$ (LTC1542)			0.7	mV/V	
		Commercial Grade	●		0.8	mV/V	
		Industrial Grade	●		0.9	mV/V	
PSRR	Power Supply Rejection Ratio	$V_{CC} = 3\text{V}$ to $12\text{V}$			0.25	mV/V	
		Commercial Grade (SO-8)	●		0.30	mV/V	
		Industrial Grade (SO-8)	●		0.35	mV/V	
$t_{PD}$	Propagation Delay	Overdrive = 10mV Overdrive = 100mV		20 8		$\mu\text{s}$ $\mu\text{s}$	
$V_{OH}$	Output High Voltage	$I_{OUT} = -2\text{mA}$	●	$V_{CC} - 0.2\text{V}$		V	
$V_{OL}$	Output Low Voltage	$I_{OUT} = 1.8\text{mA}$	●		$V_{SS} + 0.3\text{V}$	V	
<b>Reference (LTC1541 Only)</b>							
$V_{REF}$	Reference Voltage	No Load (SO-8)		1.195	1.200	1.205	V
		Commercial Grade (SO-8)	●	1.190		1.210	V
		Industrial Grade (SO-8)	●	1.188		1.212	V
		No Load (MSOP)		1.190	1.200	1.210	V
		Commercial Grade (MSOP)	●	1.185		1.215	V
		Industrial Grade (MSOP)	●	1.183		1.217	V
		No Load (DFN)		1.185	1.200	1.215	V
		Commercial Grade (DFN)	●	1.180		1.220	V
		Industrial Grade (DFN)	●	1.178		1.222	V
$\Delta V_{REF}$	Load Regulation	$I_{SOURCE} = 2\text{mA}$ $I_{SINK} = 10\mu\text{A}$	●	2	6	mV	
			●	0.2	1.5	mV	
					5	mV	
$e_n$	Voltage Noise	0.1Hz to 10Hz		16		$\mu\text{V}_{P-P}$	
<b>Op Amp</b>							
$V_{OS}$	Input Offset Voltage	$V_{CM} = 2.5\text{V}$ (SO-8)			0.7	mV	
		Commercial Grade (SO-8)	●		1.25	mV	
		Industrial Grade (SO-8)	●		1.65	mV	
		$V_{CM} = 2.5\text{V}$ (MSOP) (DFN)			1.00	mV	
		Commercial Grade (MSOP) (DFN)	●		1.75	mV	
		Industrial Grade (MSOP) (DFN)	●		2.0	mV	

# LTC1541/LTC1542

## ELECTRICAL CHARACTERISTICS

The ● denotes specifications which apply over the full operating temperature range, otherwise specifications are at  $T_A = 25^\circ\text{C}$ .  $V_{CC} = 5\text{V}$ ,  $V_{SS} = 0\text{V}$ , unless otherwise noted.

SYMBOL	PARAMETER	CONDITIONS	MIN	TYP	MAX	UNITS
$I_B$	Input Bias Current	$V_{CM} = 2.5\text{V}$	●	0.01	1	nA
$A_{VOL}$	Large-Signal Gain	AMPOUT = 0.5V to 4.5V, No Load		80	1000	V/mV
		AMPOUT = 0.5V to 4.5V, $R_{LOAD} = 100\text{k}$		60	500	V/mV
		Commercial Grade	●	38		V/mV
		Industrial Grade	●	35		V/mV
GBW	Gain Bandwidth	$A_V = 1\text{V/V}$		12		kHz
SR	Slew Rate	$A_V = 1\text{V/V}$		8		V/ms
$V_{CM}$	Input Common Mode Range		●	$V_{SS}$	$V_{CC} - 1.3\text{V}$	V
CMRR	Common Mode Rejection Ratio	$V_{CM} = V_{SS}$ to $(V_{CC} - 1.3\text{V})$			0.5	mV/V
		Commercial Grade	●		0.6	mV/V
		Industrial Grade	●		0.6	mV/V
PSRR	Power Supply Rejection Ratio	$V_{CC} = 3\text{V}$ to $12\text{V}$			0.19	mV/V
		Commercial Grade	●		0.21	mV/V
		Industrial Grade	●		0.23	mV/V
$V_{OH}$	Output High Voltage	$R_{LOAD} = 100\text{k}$ to $V_{SS}$		$V_{CC} - 0.07$		V
		Commercial Grade	●	$V_{CC} - 0.10$		V
		Industrial Grade	●	$V_{CC} - 0.12$		V
$V_{OL}$	Output Low Voltage	$R_{LOAD} = 100\text{k}$ to $V_{CC}$			$V_{SS} + 0.05$	V
		Commercial Grade	●		$V_{SS} + 0.10$	V
		Industrial Grade	●		$V_{SS} + 0.12$	V
$I_{SOURCE}$	Output Source Current		●	0.9	1.8	mA
				0.7		mA
$I_{SINK}$	Output Sink Current		●	1.3	1.8	mA
				0.9		mA
$e_n$	Input Noise Voltage	$f_0 = 0.1\text{Hz}$ to $10\text{Hz}$		3		$\mu\text{V}_{P-P}$

The ● denotes specifications which apply over the full operating temperature range, otherwise specifications are at  $T_A = 25^\circ\text{C}$ .  $V_{CC} = 3\text{V}$ ,  $V_{SS} = 0\text{V}$ , unless otherwise noted.

SYMBOL	PARAMETER	CONDITIONS	MIN	TYP	MAX	UNITS	
<b>Power Supply</b>							
$V_{CC}$	Supply Voltage Range		●	2.5	12.6	V	
$I_{CC}$	Supply Current (Note 2)			4.5	9.5	$\mu\text{A}$	
		Commercial Grade	●		15	$\mu\text{A}$	
		Industrial Grade	●		16	$\mu\text{A}$	
<b>Comparator</b>							
$V_{OS}$	Input Offset Voltage (Note 3)	(SO-8)			1.0	mV	
		Commercial Grade (SO-8)	●		1.5	mV	
		Industrial Grade (SO-8)	●		2.0	mV	
		(MSOP)(DFN)			1.2	mV	
$V_{TRIP}$	Trip Point (Note 4)	Commercial Grade (MSOP)(DFN)	●	1.80	2.35	2.90	mV
		Industrial Grade (MSOP)(DFN)	●	1.00	3.90		mV
			●		0.01	1	nA
$V_{CM}$	Input Common Mode Range		●	$V_{SS}$	$V_{CC} - 1.3$	V	
CMRR	Common Mode Rejection Ratio	$V_{CM} = V_{SS}$ to $(V_{CC} - 1.3\text{V})$ (LTC1542)			0.8	mV/V	
		Commercial Grade	●		0.9	mV/V	
		Industrial Grade	●		1.0	mV/V	

15412fd

## ELECTRICAL CHARACTERISTICS

The ● denotes specifications which apply over the full operating temperature range, otherwise specifications are at  $T_A = 25^\circ\text{C}$ .  $V_{CC} = 3\text{V}$ ,  $V_{SS} = 0\text{V}$ , unless otherwise noted.

SYMBOL	PARAMETER	CONDITIONS	MIN	TYP	MAX	UNITS
PSRR	Power Supply Rejection Ratio	$V_{CC} = 3\text{V}$ to $12\text{V}$			0.25	mV/V
		Commercial Grade	●		0.30	mV/V
		Industrial Grade	●		0.35	mV/V
$t_{PD}$	Propagation Delay	Overdrive = $10\text{mV}$		25		$\mu\text{s}$
		Overdrive = $100\text{mV}$		12		$\mu\text{s}$
$V_{OH}$	Output High Voltage	$I_{OUT} = -2\text{mA}$	●	$V_{CC} - 0.2$		V
$V_{OL}$	Output Low Voltage	$I_{OUT} = 1.8\text{mA}$	●		$V_{SS} + 0.3$	V

### Reference (LTC1541 Only)

$V_{REF}$	Reference Voltage	No Load (SO-8)	●	1.195	1.200	1.205	V		
		Commercial Grade (SO-8)	●	1.190		1.210	V		
		Industrial Grade (SO-8)	●	1.188		1.212	V		
		No Load (MSOP)	●	1.190	1.200	1.210	V		
		Commercial Grade (MSOP)	●	1.185		1.215	V		
		Industrial Grade (MSOP)	●	1.183		1.217	V		
		No Load (DFN)	●	1.185	1.200	1.215	V		
		Commercial Grade (DFN)	●	1.180		1.220	V		
		Industrial Grade (DFN)	●	1.178		1.222	V		
		$\Delta V_{REF}$	Load Regulation	$I_{SOURCE} = 1\text{mA}$	●		2	6	mV
				$I_{SINK} = 10\mu\text{A}$	●		0.2	1.5	mV
					●			5	mV
$e_n$	Voltage Noise	0.1Hz to 10Hz		16		$\mu\text{V}_{P-P}$			

### Op Amp

$V_{OS}$	Input Offset Voltage	$V_{CM} = 1.5\text{V}$ (SO-8)	●			0.7	mV
		Commercial Grade (SO-8)	●			1.25	mV
		Industrial Grade (SO-8)	●			1.65	mV
		$V_{CM} = 1.5\text{V}$ (MSOP)	●			1.00	mV
		Commercial Grade (MSOP) (DFN)	●			1.75	mV
		Industrial Grade (MSOP) (DFN)	●			2.0	mV
$I_B$	Input Bias Current	$V_{CM} = 1.5\text{V}$	●		0.01	1	nA
$A_{VOL}$	Large-Signal Gain	AMPOUT = $0.5\text{V}$ to $2.5\text{V}$ , No Load		80.0	1000		V/mV
		AMPOUT = $0.5\text{V}$ to $2.5\text{V}$ , $R_{LOAD} = 100\text{k}$		45.5	500		V/mV
		Commercial Grade	●	22.0			V/mV
		Industrial Grade	●	20.0			V/mV
GBW	Gain Bandwidth	$A_V = 1\text{V/V}$			12		kHz
SR	Slew Rate	$A_V = 1\text{V/V}$			8		V/ms
$V_{CM}$	Input Common Mode Range		●	$V_{SS}$		$V_{CC} - 1.3$	V
CMRR	Common Mode Rejection Ratio	$V_{CM} = V_{SS}$ to $(V_{CC} - 1.3\text{V})$	●			0.7	mV/V
		Commercial Grade	●			0.8	mV/V
		Industrial Grade	●			0.8	mV/V
PSRR	Power Supply Rejection Ratio	$V_{CC} = 3\text{V}$ to $12\text{V}$	●			0.19	mV/V
		Commercial Grade	●			0.21	mV/V
		Industrial Grade	●			0.23	mV/V
$V_{OH}$	Output High Voltage	$R_{LOAD} = 100\text{k}$ to $V_{SS}$	●	$V_{CC} - 0.07$			V
		Commercial Grade	●	$V_{CC} - 0.10$			V
		Industrial Grade	●	$V_{CC} - 0.12$			V
$V_{OL}$	Output Low Voltage	$R_{LOAD} = 100\text{k}$ to $V_{CC}$	●			$V_{CC} + 0.05$	V
		Commercial Grade	●			$V_{CC} + 0.10$	V
		Industrial Grade	●			$V_{CC} + 0.12$	V

# LTC1541/LTC1542

## ELECTRICAL CHARACTERISTICS

The ● denotes specifications which apply over the full operating temperature range, otherwise specifications are at  $T_A = 25^\circ\text{C}$ .  $V_{CC} = 3\text{V}$ ,  $V_{SS} = 0\text{V}$ , unless otherwise noted.

SYMBOL	PARAMETER	CONDITIONS	MIN	TYP	MAX	UNITS
$I_{\text{SOURCE}}$	Output Source Current		0.6 0.4	0.95		mA mA
$I_{\text{SINK}}$	Output Sink Current		1.2 0.8	1.8		mA mA
$e_n$	Input Noise Voltage	$f_0 = 0.1\text{Hz to }10\text{Hz}$		3		$\mu\text{V}_{\text{P-P}}$

**Note 1:** Absolute Maximum Ratings are those values beyond which the life of the device may be impaired.

**Note 2:** Supply current is tested with  $\text{COMPIN}^+ = (\text{REF} - 100\text{mV})$  for LTC1541 and  $\text{COMPIN}^+ = 0\text{V}$ ,  $\text{COMPIN}^- = 100\text{mV}$  for LTC1542.

**Note 3:** Input offset voltage is defined as the center of the input referred hysteresis,  $V_{\text{CM}} = \text{REF}$  (LTC1541).  $V_{\text{CM}} = 1/2 V_{\text{CC}}$  (LTC1542).

**Note 4:** Trip point is defined as the differential input voltage required to make the comparator output change state. The difference between upper and lower trip point is equal to the width of the input referred hysteresis,  $V_{\text{CM}} = \text{REF}$  (LTC1541).  $V_{\text{CM}} = 1/2 V_{\text{CC}}$  (LTC1542).

**Note 5:** The input leakage current is measured for  $\text{COMPIN}^+ = 0\text{V}$  (LTC1541) and  $\text{COMPIN}^+ = \text{COMPIN}^- = 0\text{V}$  (LTC1542).

**Note 6:** The  $\theta_{\text{JA}}$  specified for the DD package is with minimal PCB heat spreading metal. Using expanded metal area on all layers of a board reduces this value.

**Note 7:** The LTC1541C/LTC1541I and LTC1542C/LTC1542I are guaranteed functional over the operating temperature range of  $-40^\circ\text{C}$  to  $85^\circ\text{C}$ .

**Note 8:** The LTC1541C and LTC1542C are guaranteed to meet specified performance from  $0^\circ\text{C}$  to  $70^\circ\text{C}$ . The LTC1541C and LTC1542C are designed, characterized and expected to meet performance from  $-40^\circ\text{C}$  to  $85^\circ\text{C}$ , but are not tested or QA sampled at these temperatures. The LTC1541I and LTC1542I are guaranteed to meet specified performance from  $-40^\circ\text{C}$  to  $85^\circ\text{C}$ .

## TYPICAL PERFORMANCE CHARACTERISTICS

Supply Current vs Supply Voltage

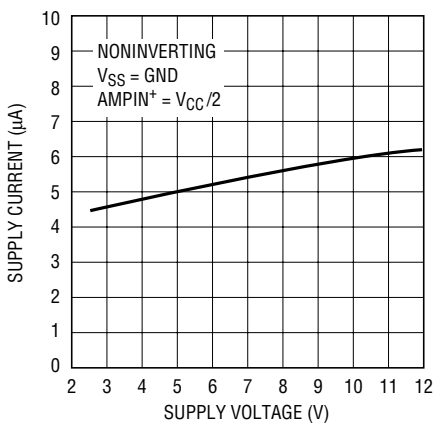

1541/42 TPC01

Supply Current vs Temperature

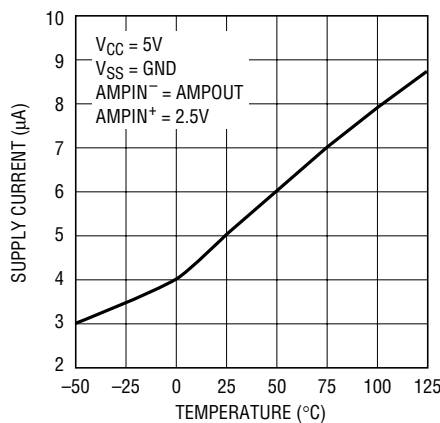

1541/42 TPC02

Reference Output Voltage vs Load Current

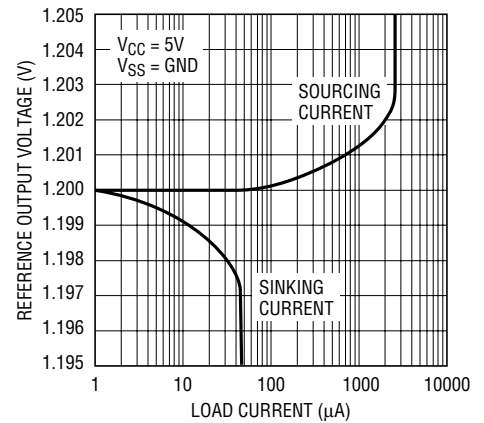

1541/42 TPC03

# TYPICAL PERFORMANCE CHARACTERISTICS

Reference Output Voltage vs Temperature

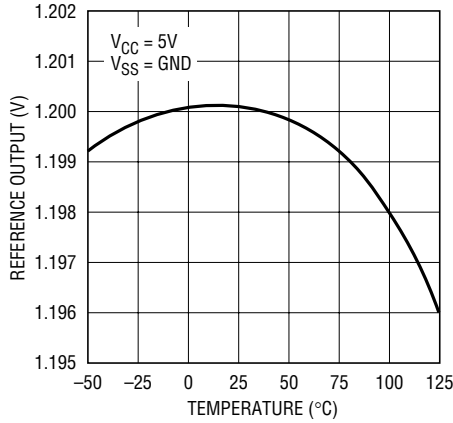

1541/42 TPC04

Op Amp DC Open-Loop Gain vs Temperature

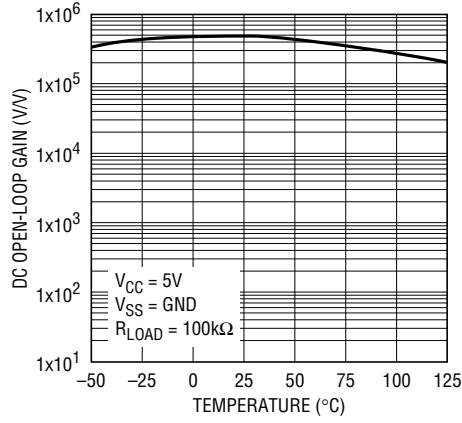

1541/42 TPC05

Op Amp Output Voltage vs Load Current

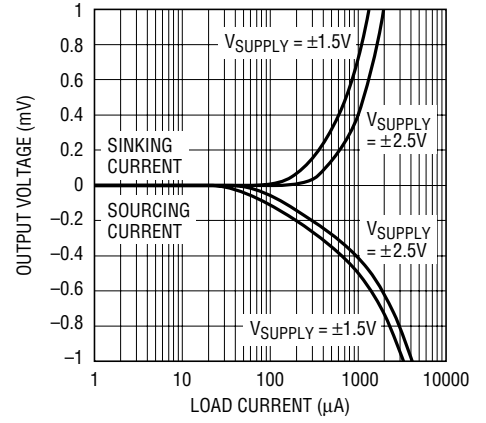

1541/42 TPC06

Op Amp Short-Circuit Current vs Supply Voltage

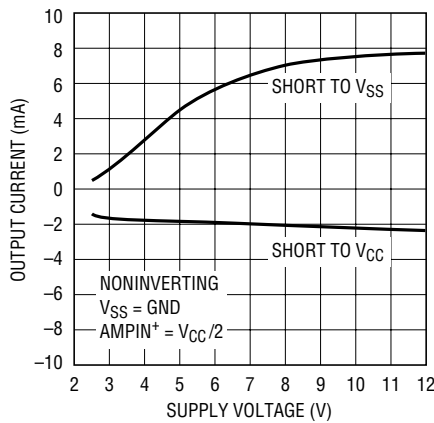

1541/42 TPC07

Op Amp DC Open-Loop Gain vs Supply Voltage

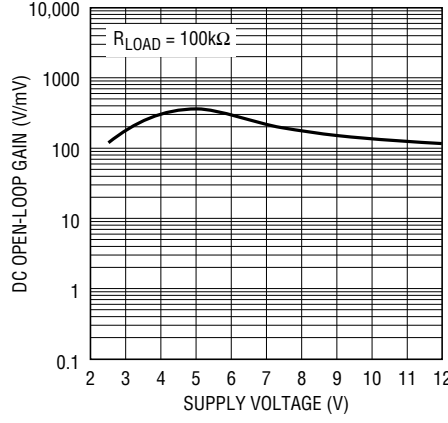

1541/42 TPC08

Comparator Output Voltage vs Load Current

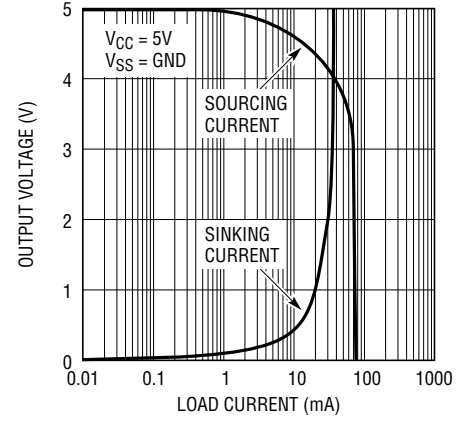

1541/42 TPC09

Comparator Short-Circuit Current vs Supply Voltage

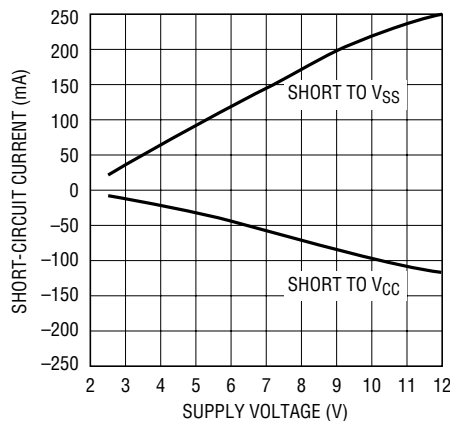

1541/42 TPC10

Op Amp Small-Signal Transient Response

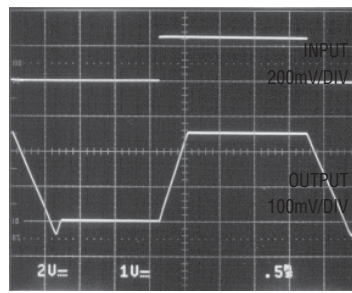

NONINVERTING  
 $A_{VCL} = 1V/V$   
 LOAD = 100kΩ//100pF TO  $V_{SS}$   
 $V_{SUPPLY} = 5V$

1541/42 TPC11

Op Amp Large-Signal Transient Response

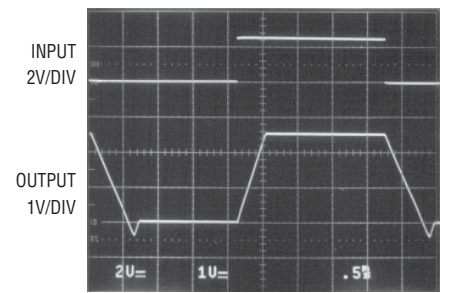

NONINVERTING  
 $A_{VCL} = 1V/V$   
 LOAD = 100kΩ//100pF TO  $V_{SS}$   
 $V_{SUPPLY} = 5V$

1541/42 TPC12

## TYPICAL PERFORMANCE CHARACTERISTICS

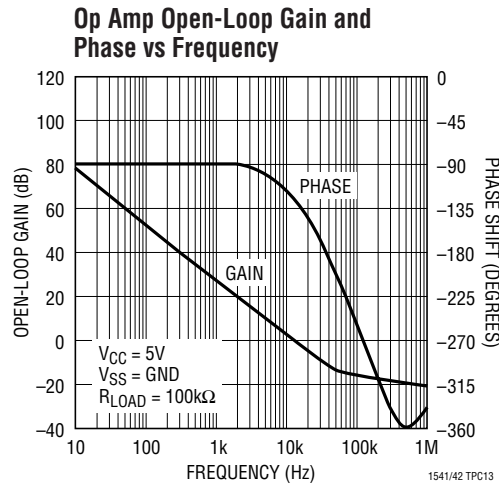

## PIN FUNCTIONS

**AMPOUT (Pin 1):** Op Amp Output. The output can swing from rail-to-rail while driving a capacitive load of up to 1000pF. The output can source and sink 0.7mA (min).

**AMPIN<sup>-</sup> (Pin 2):** Inverting Input of Op Amp. The input common mode ranges from  $V_{SS}$  to  $(V_{CC} - 1.3V)$ . The input current is typically 10pA at 25°C.

**AMPIN<sup>+</sup> (Pin 3):** Noninverting Input of Op Amp. The input common mode ranges from  $V_{SS}$  to  $(V_{CC} - 1.3V)$ . The input current is typically 10pA at 25°C.

**V<sub>SS</sub> (Pin 4):** Negative Supply or Ground Connection.

**COMPIN<sup>+</sup> (Pin 5):** Noninverting Input of Comparator. The input common mode ranges from  $V_{SS}$  to  $(V_{CC} - 1.3V)$ . The input current is typically 10pA at 25°C.

**REF (Pin 6) (LTC1541):** Reference Output.  $V_{REF} = 1.2V \pm 1\%$  over industrial temperature range, and is also connected to inverting comparator input internally. This device can source up to 2mA and sink up to 20 $\mu$ A. The output can drive a bypass capacitor of up to 0.01 $\mu$ F without oscillation.

**COMPIN<sup>-</sup> (Pin 6) (LTC1542):** Inverting Input of Comparator. The input common mode ranges from  $V_{SS}$  to  $(V_{CC} - 1.3V)$ . The input current is typically 10pA at 25°C.

**COMPOUT (Pin 7):** Comparator Output. The output can source 20mA and sink 5mA.

**V<sub>CC</sub> (Pin 8):** Positive Supply,  $2.5V \leq V_{CC} \leq 12.6V$ . The supply bypass capacitors are not required if the supply impedance is low. For single supply applications, it is a good general practice to bypass  $V_{CC}$  with a 0.1 $\mu$ F capacitor to ground.

## BLOCK DIAGRAMS

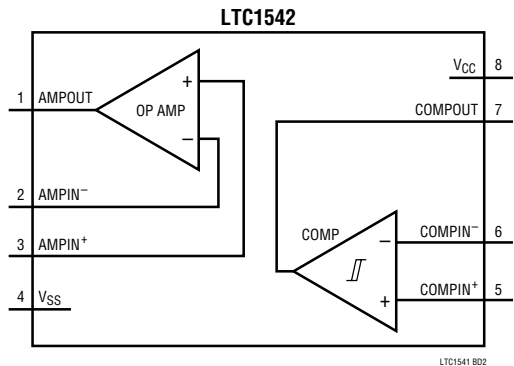
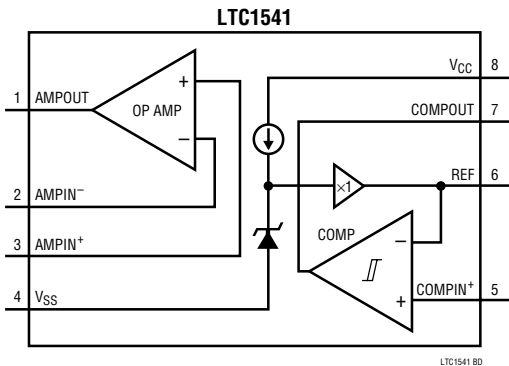

## APPLICATIONS INFORMATION

The LTC1541/LTC1542 are a combination of a micropower op amp, comparator and  $1.2V \pm 1\%$  reference (LTC1541) in an 8-pin package. The LTC1541 has the negative input of the comparator internally connected to the reference output. The supply voltage range is from 2.5V to 12.6V for single supply and  $\pm 1.25V$  to  $\pm 6.3V$  for dual supplies. The supply current is a mere  $5\mu A$  (typical) with a 5V single supply.

### Op Amp

The op amp is internally compensated to be unity-gain stable, with typical GBW at 12kHz and slew rate of 8V/ms. The output can drive a capacitive load of up to 1000pF and swings from rail-to-rail. The input range is from the negative rail to within 1.3V of the positive rail. The input bias current is less than 1nA maximum at the extended temperature range.

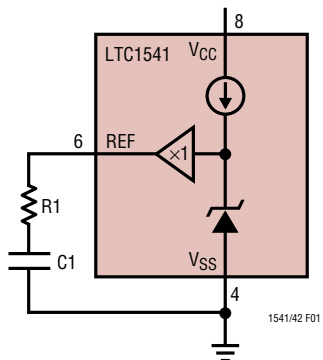

Figure 1. Damping the Reference Output

### Comparator

The comparator has a high impedance differential input stage with a common mode input range from the negative rail to within 1.3V of the positive rail. The CMOS output stage can swing from rail-to-rail and source up to 20mA continuously. The output stage has been designed to eliminate the power supply glitches that normally occur when the output changes logic state. In addition, internal hysteresis ( $\pm 2.25mV$ ) ensures clean output switching even with slow moving input signals. The negative input is internally connected to the reference for the LTC1541.

### Reference

The internal bandgap reference has an output voltage of  $1.2V \pm 1\%$  over the industrial grade temperature range.

The output can source up to 2mA and sink up to  $20\mu A$  with a 5V supply. The output can drive a bypass capacitor of up to  $0.01\mu F$  without oscillation and by inserting a series resistor, capacitance values up to  $100\mu F$  can be used (Figure 1). Figure 2 shows the resistor value required for different capacitor values to achieve critical damping. Bypassing the reference can help prevent false tripping of the comparator by preventing glitches on  $V_{CC}$  or reference load transients from disturbing the reference output voltage. Figures 3a and 3b show the bypass reference output with a square wave applied to the  $V_{CC}$  pin while resistor R1 damps the reference response. Note that the comparator output doesn't trip.

### Op Amp Stability

Unlike other industry standard micropower CMOS op amps, the op amp in the LTC1541/LTC1542 maintain stability in unity-gain configuration while driving heavy capacitive loads of up to 1000pF.

Although this family is primarily designed for low frequency applications, good layout is extremely important. Low power, high impedance circuits may increase the effects of board leakage and stray capacitance. For example, the combination of a 10M resistance (from leakage between traces on a contaminated, poorly designed PC board) and a 1pF stray capacitance provides a pole at approximately 16kHz, which is near the amplifier's bandwidth. Board routing and layout should minimize leakage and stray capacitance. In some cases, stray capacitance may be unavoidable and it may be necessary to add a small capacitor across the feedback resistor to compensate (Figure 4); select the smallest capacitor value that ensures stability.

### Inputs

The input common mode range for both the op amp and comparator is from the negative supply to within 1.3V of the positive supply. The inputs can be taken more than 300mV below the negative supply without damaging the device if the current out of the pin is limited to less than 1mA. Unlike bipolar input op amps and comparators, the outputs of the CMOS LTC1541/LTC1542 will not reverse phase when the inputs are taken above the common mode input range.



## APPLICATIONS INFORMATION

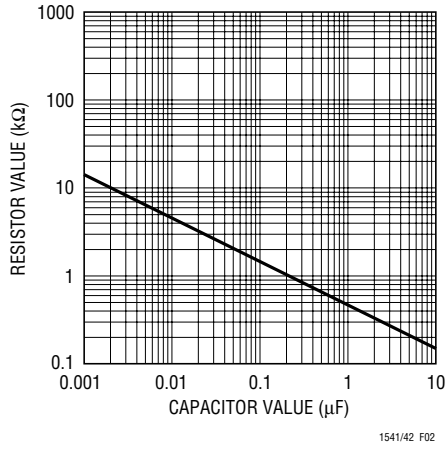

Figure 2. Damping Resistance vs Bypass Capacitor Value

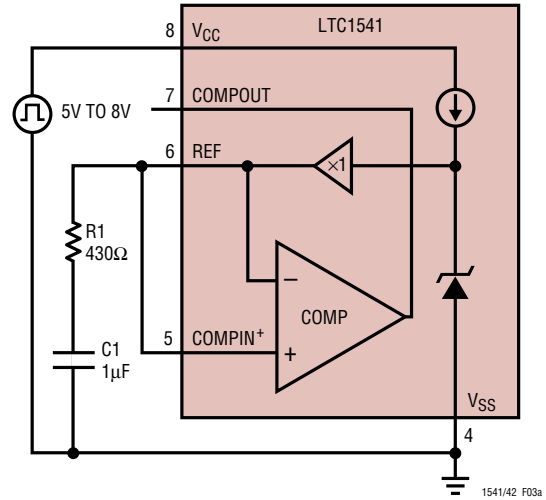

Figure 3a. Reference Transient Response Test Circuit

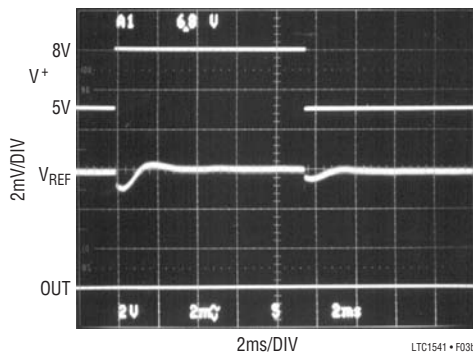

Figure 3b. Reference and Comparator Output Transient Response

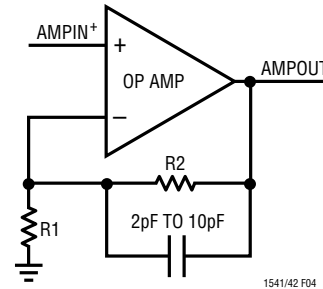
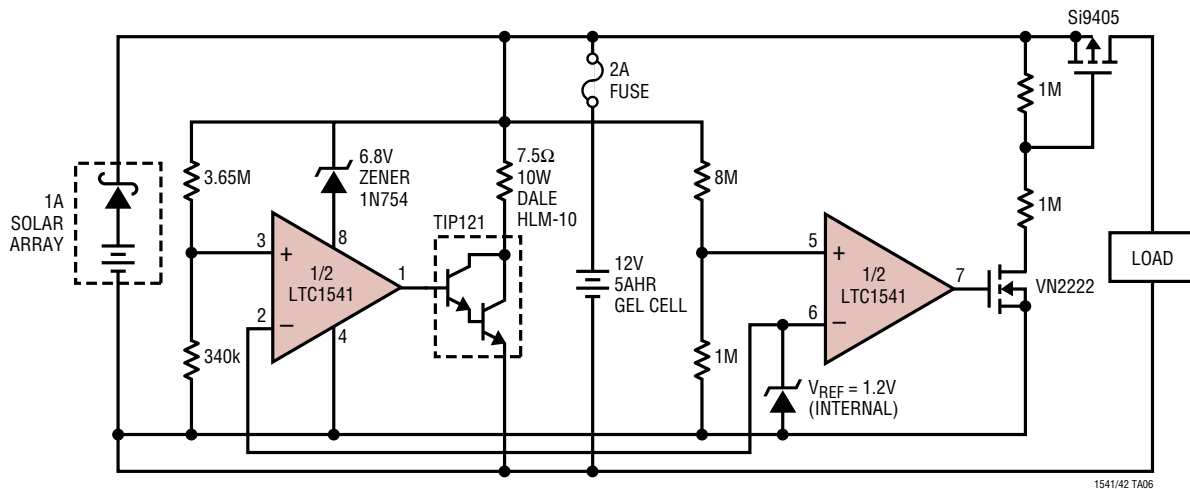

Figure 4. Compensation for Feedback Node Capacitance

## TYPICAL APPLICATIONS

### Shunt Battery Charger with Low-Battery Load Disconnect



1541/42 TA06

15412fd

# PACKAGE DESCRIPTION

## DD Package 8-Lead Plastic DFN (3mm × 3mm) (Reference LTC DWG # 05-08-1698)

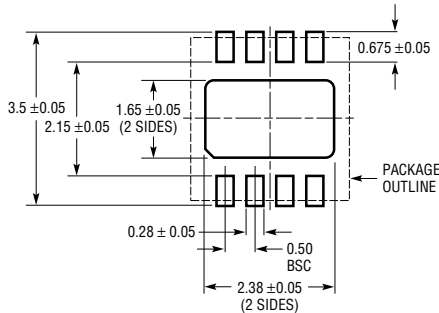

RECOMMENDED SOLDER PAD PITCH AND DIMENSIONS

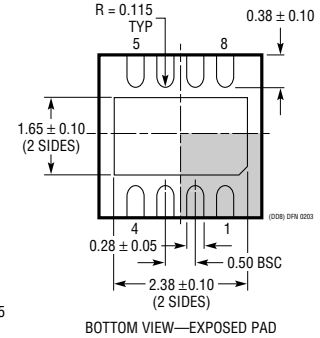
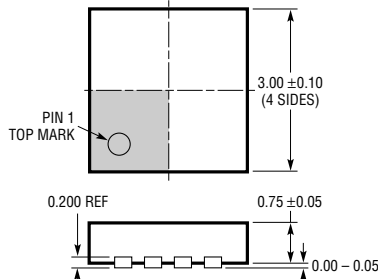

BOTTOM VIEW—EXPOSED PAD

- NOTE:
1. DRAWING TO BE MADE A JEDEC PACKAGE OUTLINE MO-229 VARIATION OF (WEED-1)
  2. ALL DIMENSIONS ARE IN MILLIMETERS
  3. DIMENSIONS OF EXPOSED PAD ON BOTTOM OF PACKAGE DO NOT INCLUDE MOLD FLASH. MOLD FLASH, IF PRESENT, SHALL NOT EXCEED 0.15mm ON ANY SIDE
  4. EXPOSED PAD SHALL BE SOLDER PLATED

## MS8 Package 8-Lead Plastic MSOP (Reference LTC DWG # 05-08-1660)

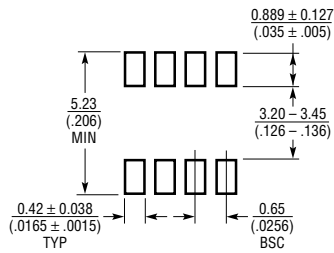

RECOMMENDED SOLDER PAD LAYOUT

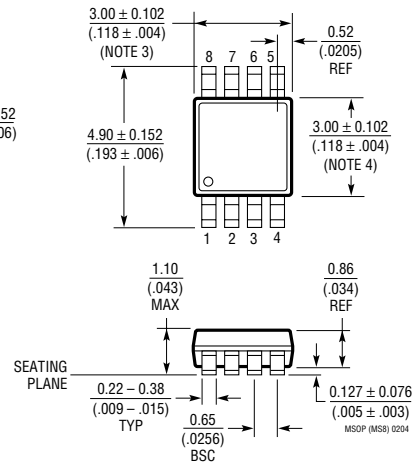
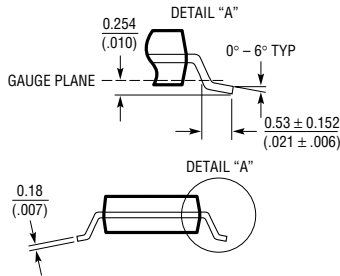

- NOTE:
1. DIMENSIONS IN MILLIMETER/(INCH)
  2. DRAWING NOT TO SCALE
  3. DIMENSION DOES NOT INCLUDE MOLD FLASH, PROTRUSIONS OR GATE BURRS. MOLD FLASH, PROTRUSIONS OR GATE BURRS SHALL NOT EXCEED 0.152mm (.006") PER SIDE
  4. DIMENSION DOES NOT INCLUDE INTERLEAD FLASH OR PROTRUSIONS. INTERLEAD FLASH OR PROTRUSIONS SHALL NOT EXCEED 0.152mm (.006") PER SIDE
  5. LEAD COPLANARITY (BOTTOM OF LEADS AFTER FORMING) SHALL BE 0.102mm (.004") MAX

## S8 Package 8-Lead Plastic Small Outline (Narrow .150 Inch) (Reference LTC DWG # 05-08-1610)

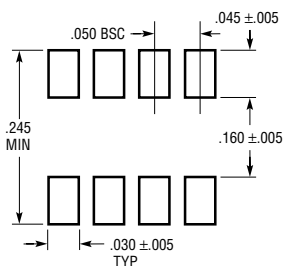

RECOMMENDED SOLDER PAD LAYOUT

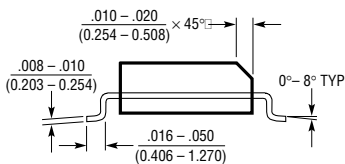

- NOTE:
1. DIMENSIONS IN INCHES (MILLIMETERS)
  2. DRAWING NOT TO SCALE
  3. THESE DIMENSIONS DO NOT INCLUDE MOLD FLASH OR PROTRUSIONS. MOLD FLASH OR PROTRUSIONS SHALL NOT EXCEED .006" (0.15mm)

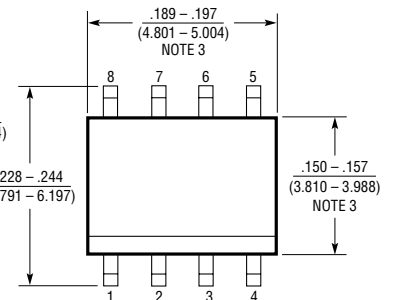
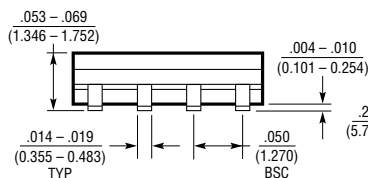

S08 0303

## TYPICAL APPLICATIONS

### Negative Reference

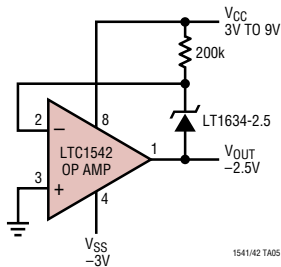

### Single Supply Function Generator

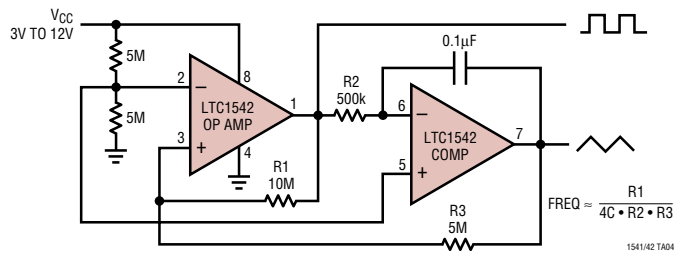

### Voltage Control Oscillator

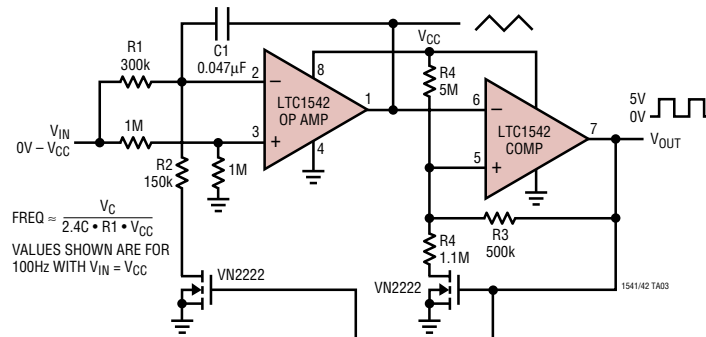

### Linear Lithium-Ion Charger

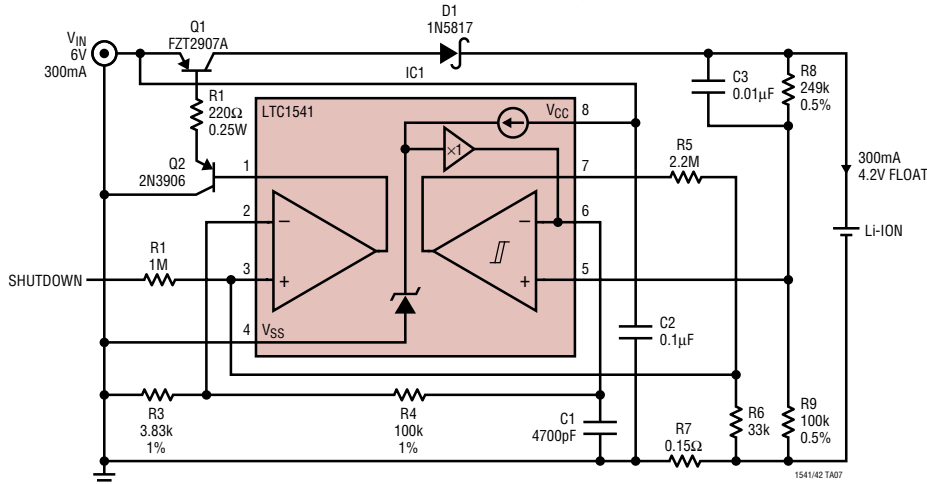

## RELATED PARTS

PART NUMBER	DESCRIPTION	COMMENTS
LT®1078/LT1079	Dual/Quad Micropower, Single Supply Precision Op Amps	70µV, V <sub>OS</sub> Max and 0.4µV/°C Drift, 200kHz GBW, 0.07V/µs Slew Rate, Input/Output Common Mode Includes Ground
LT1178/LT1179	Dual/Quad 17µA Max, Single Supply Precision Op Amps	70µV, V <sub>OS</sub> Max and 2.5µV/°C Drift Max, 85kHz GBW, 0.04V/µs Slew Rate, Input/Output Common Mode Includes Ground
LT1490/LT1491	Dual/Quad Micropower Rail-to-Rail Input and Output Op Amps	Single Supply Input Range: -0.4V to 44V, Micropower 50µA Amplifier, Rail-to-Rail Input and Output, 200kHz GBW
LT1635	Micropower Rail-to-Rail Op Amp and Reference	130µA of Supply Current, 1.3mV V <sub>OS</sub> Max
LT2078/LT2079	Dual/Quad Micropower, Single Supply Precision Op Amps	SO-8 and 14-Lead Standard Pinout, 70µV V <sub>OS</sub> Max, 200kHz GBW
LT2178/LT2179	Dual/Quad 17µA Max, Single Supply Precision Op Amps	SO-8 and 14-Lead Standard Pinout, 70µV V <sub>OS</sub> Max, 85kHz GBW

15412f2d

# Mouser Electronics

Authorized Distributor

Click to View Pricing, Inventory, Delivery & Lifecycle Information:

## [Analog Devices Inc.:](#)

[LTC1541CS8](#) [LTC1541IMS8#TR](#) [LTC1541CMS8#PBF](#) [LTC1541IDD#TRPBF](#) [LTC1542CMS8](#) [LTC1542CDD#PBF](#)  
[LTC1542IDD#TR](#) [LTC1541CDD#PBF](#) [LTC1542CMS8#TRPBF](#) [LTC1542IMS8#PBF](#) [LTC1541IS8#PBF](#)  
[LTC1542CMS8#PBF](#) [LTC1541CS8#PBF](#) [LTC1541IDD](#) [LTC1542CS8#TRPBF](#) [LTC1542IMS8#TR](#) [LTC1542CS8](#)  
[LTC1542IDD#TRPBF](#) [LTC1541IS8](#) [LTC1542IS8#PBF](#) [LTC1541CS8#TR](#) [LTC1541CDD#TR](#) [LTC1541IDD#PBF](#)  
[LTC1541CDD](#) [LTC1542IMS8#TRPBF](#) [LTC1541IS8#TRPBF](#) [LTC1541IMS8](#) [LTC1541CMS8#TR](#) [LTC1542CDD#TR](#)  
[LTC1542IS8#TR](#) [LTC1542CDD](#) [LTC1542IS8#TRPBF](#) [LTC1542CDD#TRPBF](#) [LTC1542IDD](#) [LTC1541CMS8](#)  
[LTC1541CMS8#TRPBF](#) [LTC1542IS8](#) [LTC1541IMS8#PBF](#) [LTC1542CMS8#TR](#) [LTC1542CS8#TR](#) [LTC1542IDD#PBF](#)  
[LTC1541IS8#TR](#) [LTC1542CS8#PBF](#) [LTC1541IDD#TR](#) [LTC1541CS8#TRPBF](#) [LTC1541IMS8#TRPBF](#)  
[LTC1541CDD#TRPBF](#) [LTC1542IMS8](#)