

Electrical Characteristics

(Ratings at $T_A=25^\circ\text{C}$ ambient temperature unless otherwise specified. $V_f=0.9\text{V}$ at $I_f=10\text{mA}$)

Parameter	Conditions	Symbol	Min	Typ	Max	Unit
Reverse stand-off voltage		V_{RWM}			5	V
Reverse leakage current	$V_R = 5\text{ V}$	I_R			1	μA
Reverse breakdown voltage	$I_R = 1\text{ mA}$	$V_{(BR)}$	5.6			V
Clamping voltage	$I_{PP} = 5\text{ A}$, $t_p = 8/20\mu\text{s}$	V_C			11.6	V
	$I_{PP} = 9.4\text{ A}$, $t_p = 8/20\mu\text{s}$	V_C			18.6	V
Junction capacitance	$V_R = 0\text{V}$, $F = 1\text{MHz}$	C_J		15		pF

NOTES:

1. Surge current waveform per Fig.1
2. V_{BR} is measured with a pulse test current I_R at an ambient temperature of 25°C .

RATING AND CHARACTERISTIC CURVES (CPDQ5V0-HF)

Fig.1 - Pulse Waveform

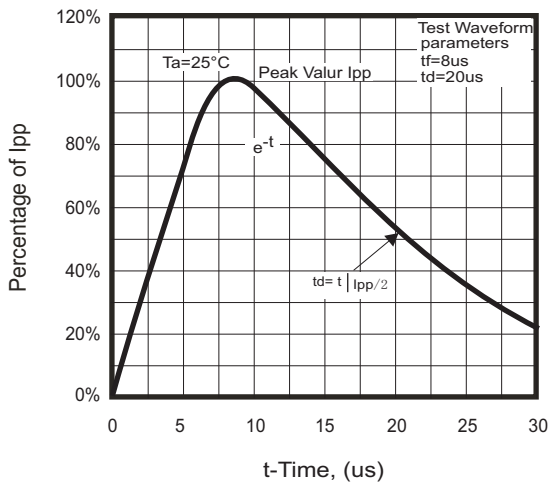
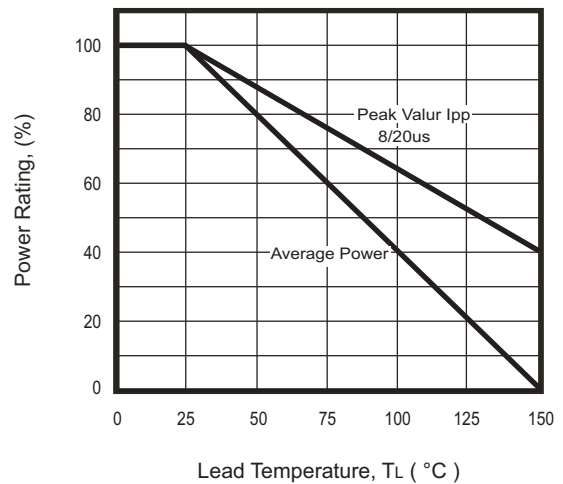
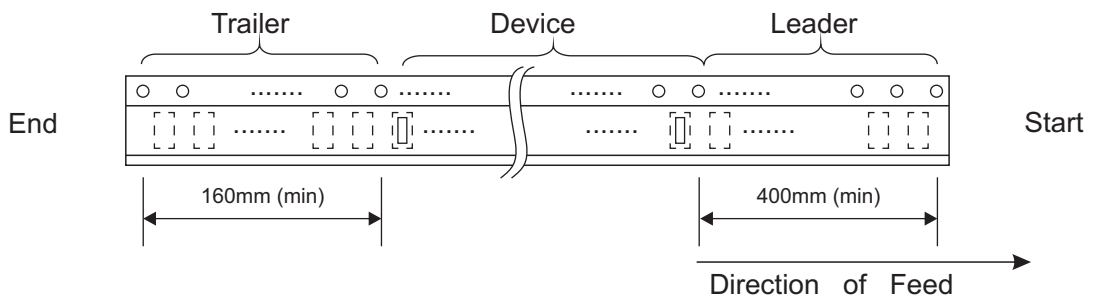
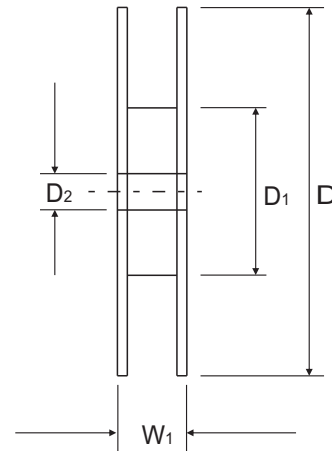
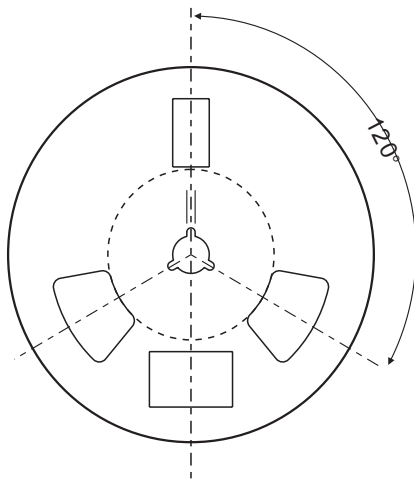
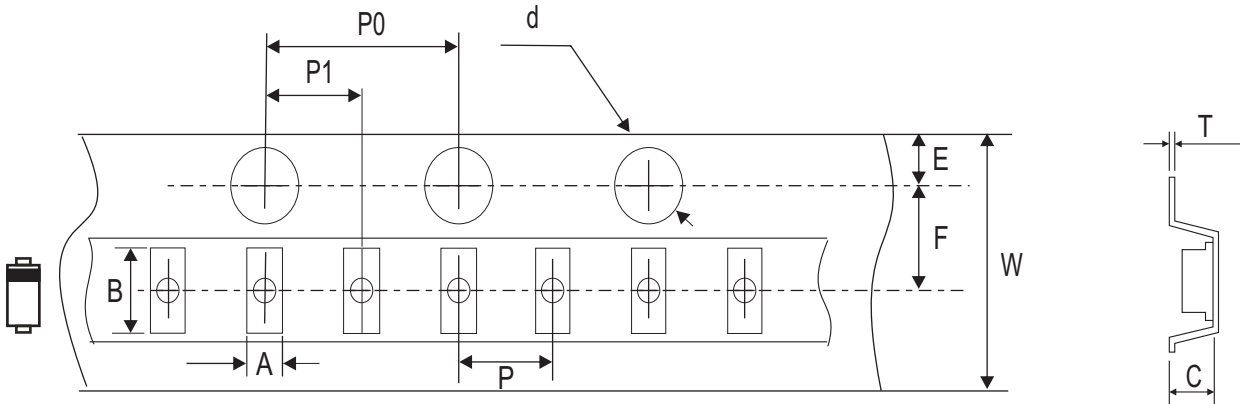

Fig. 2 - Power Derating Curve



Reel Taping Specification



0402 (SOD-923F)	SYMBOL	A	B	C	d	D	D ₁	D ₂
	(mm)	0.70 ± 0.05	1.12 ± 0.05	0.48 ± 0.05	1.50 + 0.10 - 0	178.00 Max.	50.00 Min.	13.00 ± 0.50
	(inch)	0.028 ± 0.002	0.044 ± 0.002	0.019 ± 0.002	0.059 + 0.004 - 0	7.008 Max.	1.969 Min.	0.512 ± 0.020

0402 (SOD-923F)	SYMBOL	E	F	P	P ₀	P ₁	T	W	W
	(mm)	1.75 ± 0.10	3.50 ± 0.05	2.00 ± 0.05	4.00 ± 0.10	2.00 ± 0.05	0.229 ± 0.02	8.30 Max.	10.90 Max.
	(inch)	0.069 ± 0.004	0.138 ± 0.002	0.079 ± 0.002	0.157 ± 0.004	0.079 ± 0.002	0.009 + 0.001	0.327 Max.	0.429 Max.

Marking Code

Part Number	Marking Code	
CPDQ5V0-HF	C	C ☒



Month Code:

Month	Odd Year (per A. D.)	Even Year (per A. D.)
Jan	1	E
Feb	2	F
Wer	3	H
Apr	4	J
May	5	K
Jun	6	L
Jul	7	N
Aug	8	P
Sep	9	U
Oct	T	X
Nov	V	Y
Dec	C	Z

C: Product marking code

☒: Month Code

For example as follows:

- Product marking code: C
- Manufacture date_ Year: 2012 (Even year) / Month: Apr
 Month code: J (Month code rotated 90° and two dots below the month code.)

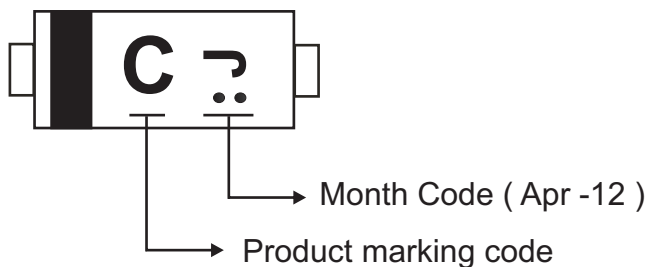

Suggested PAD Layout

SIZE	0402/SOD-923F	
	(mm)	(inch)
A	0.90	0.035
B	0.30	0.012
C	0.40	0.016
D	1.20	0.047
E	0.60	0.024

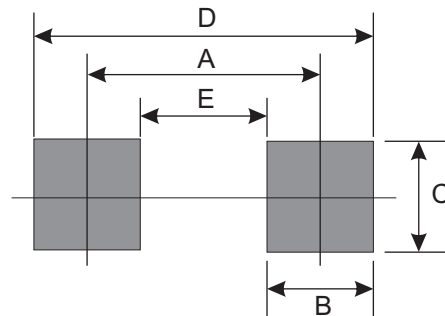

Standard Packaging

Case Type	Qty Per Reel	Reel Size
	(Pcs)	(inch)
0402/SOD-923F	8,000	7

Mouser Electronics

Authorized Distributor

Click to View Pricing, Inventory, Delivery & Lifecycle Information:

[Comchip Technology:](#)

[CPDQ5V0-HF](#)