

### ML Varistor Series

**Absolute Maximum Ratings** For ratings of individual members of a series, see Device Ratings and Specifications table.

	ML SERIES	UNITS
Continuous:		
Steady State Applied Voltage:		
DC Voltage Range ( $V_{M(DC)}$ )	3.5 to 120	V
AC Voltage Range ( $V_{M(AC)RMS}$ )	2.5 to 107	V
Transient:		
Non-Repetitive Surge Current, 8/20 $\mu$ s Waveform, ( $I_{TM}$ )	4 to 500	A
Non-Repetitive Surge Energy, 10/1000 $\mu$ s Waveform, ( $W_{TM}$ )	0.2 to 2.5	J
Operating Ambient Temperature Range ( $T_A$ )	-55 to + 125	$^{\circ}$ C
Storage Temperature Range ( $T_{STG}$ )	-55 to + 150	$^{\circ}$ C
Temperature Coefficient ( $\alpha V$ ) of Clamping Voltage ( $V_C$ ) at Specified Test Current	<0.01	%/ $^{\circ}$ C

### Device Ratings and Specifications

PART NUMBER	MAXIMUM RATINGS (125 $^{\circ}$ C)					SPECIFICATIONS (25 $^{\circ}$ C)		
	MAXIMUM CONTINUOUS WORKING VOLTAGE		MAXIMUM NON-REPETITIVE SURGE CURRENT (8/20 $\mu$ s)	MAXIMUM NON-REPETITIVE SURGE ENERGY (10/1000 $\mu$ s)	MAXIMUM CLAMPING VOLTAGE AT 10A (OR AS NOTED) (8/20 $\mu$ s)	NOMINAL VOLTAGE AT 1mA DC TEST CURRENT		TYPICAL CAPACITANCE AT f = 1MHz
	$V_{M(DC)}$	$V_{M(AC)}$	$I_{TM}$	$W_{TM}$	$V_C$	$V_{N(DC)}$ MIN	$V_{N(DC)}$ MAX	C
	(V)	(V)	(A)	(J)	(V)	(V)	(V)	(pF)
V3.5MLA0603	3.5	2.5	30	0.1	10 at 2A	3.7	7.0	1100
V3.5MLA0805	3.5	2.5	120	0.3	10 at 5A	3.7	7.0	2200
V3.5MLA0805L	3.5	2.5	40	0.1	10 at 2A	3.7	7.0	1200
V3.5MLA1206	3.5	2.5	100	0.3	14	3.7	7.0	6000
<b>NEW</b> V5.5MLA0402	5.5	4.0	20	0.050	15.5 at 1A	7.1	9.3	220
V5.5MLA0603	5.5	4.0	30	0.1	15.5 at 2A	7.1	9.3	660
V5.5MLA0805	5.5	4.0	120	0.3	15.5 at 5A	7.1	9.3	1600
V5.5MLA0805L	5.5	4.0	40	0.1	15.5 at 2A	7.1	9.3	860
V5.5MLA1206	5.5	4.0	150	0.4	15.5	7.1	9.3	4500
<b>NEW</b> V9MLA0402	9	6.5	20	0.050	22 at 1A	11	14	120
<b>NEW</b> V9MLA0402L	9	6.5	4	0.020	25 at 1A	11	14	33
V9MLA0603	9.0	6.5	30	0.1	23 at 2A	11.0	16.0	420
V9MLA0805L	9.0	6.5	40	0.1	20 at 2A	11	14	450
V12MLA0805L	12	9.0	40	0.1	25 at 2A	14	18.5	350
<b>NEW</b> V14MLA0402	14	10	20	0.050	30 at 1A	15.9	20.3	70
V14MLA0603	14	10	30	0.1	30 at 2A	15.9	20.3	150
V14MLA0805	14	10	120	0.3	30 at 5A	15.9	20.3	480
V14MLA0805L	14	10	40	0.1	30 at 2A	15.9	20.3	270
V14MLA1206	14	10	150	0.4	30	15.9	20.3	1600

# Surface Mount Varistors

## Multilayer Transient Voltage Surge Suppressors

### ML Varistor Series

#### Device Ratings and Specifications (Continued)

PART NUMBER	MAXIMUM RATINGS (125°C)					SPECIFICATIONS (25°C)		
	MAXIMUM CONTINUOUS WORKING VOLTAGE		MAXIMUM NON-REPETITIVE SURGE CURRENT (8/20 $\mu$ s)	MAXIMUM NON-REPETITIVE SURGE ENERGY (10/1000 $\mu$ s)	MAXIMUM CLAMPING VOLTAGE AT 10A (OR AS NOTED) (8/20 $\mu$ s)	NOMINAL VOLTAGE AT 1mA DC TEST CURRENT		TYPICAL CAPACITANCE AT f = 1MHz
	V <sub>M(DC)</sub>	V <sub>M(AC)</sub>	I <sub>TM</sub>	W <sub>TM</sub>	V <sub>C</sub>	V <sub>N(DC) MIN</sub>	V <sub>N(DC) MAX</sub>	C
	(V)	(V)	(A)	(J)	(V)	(V)	(V)	(pF)
<b>NEW</b> V18MLA0402	18	14	20	0.050	40 at 1A	22	28.0	40
V18MLA0603	18	14	30	0.1	40 at 2A	22	28.0	125
V18MLA0805	18	14	120	0.3	40 at 5A	22	28.0	450
V18MLA0805L	18	14	40	0.1	40 at 2A	22	28.0	250
V18MLA1206	18	14	150	0.4	40	22	28.0	1100
V18MLA1210	18	14	500	2.5	40	22	28.0	1250
V26MLA0603	26	20	30	0.1	58 at 2A	31	38	90
V26MLA0805	26	20	100	0.3	58 at 5A	29.5	38.5	190
V26MLA0805L	26	20	40	0.1	58 at 2A	29.5	38.5	115
V26MLA1206	26	20	150	0.6	56	29.5	38.5	900
V26MLA1210	26	20	300	1.2	54	29.5	38.5	1000
V30MLA0603	30	25	30	0.1	65 at 2A	37	46	75
V30MLA0805L	30	25	30	0.1	65 at 2A	37	46	80
V30MLA1210	30	25	280	1.2	62	35	43	1575
V30MLA1210L	30	25	220	0.9	62	35	43	1530
V33MLA1206	33	26	180	0.8	72	38	49	550
V42MLA1206	42	30	180	0.8	86	46	60	550
V48MLA1210	48	40	250	1.2	100	54.5	66.5	450
V48MLA1210L	48	40	220	0.9	100	54.5	66.5	430
V56MLA1206	56	40	180	1.0	110	61	77	150
V60MLA1210	60	50	250	1.5	120	67	83	375
V68MLA1206	68	50	180	1.0	130	76	90	150
V85MLA1210	85	67	250	2.5	160	95	115	225
V120MLA1210	120	107	125	2.0	230	135	165	65

NOTES:

1. L suffix is a low capacitance and energy version; Contact your Littelfuse Sales Representative for custom capacitance requirements.
2. Typical leakage at 25°C < 25 $\mu$ A, maximum leakage 50 $\mu$ A at V<sub>M(DC)</sub>; for 0402 size, typical leakage < 5 $\mu$ A, maximum leakage 10 $\mu$ A at V<sub>M(DC)</sub>.
3. Average power dissipation of transients for 0402, 0603, 0805, 1206 and 1210 sizes not to exceed 0.03W, 0.05W, 0.1W, 0.1W and 0.15W respectively.

**ML Varistor Series**

**Temperature De-rating**

When transients occur in rapid succession, the average power dissipation is the energy (watt-seconds) per pulse times the number of pulses per second. The power so developed must be within the specifications shown on the Device Ratings and Specifications table for the specific device. For applications exceeding 125°C ambient temperature, the peak surge current and energy ratings must be derated as shown in Figure 1.

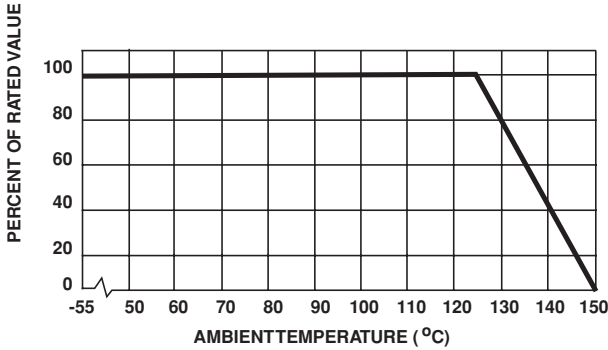

FIGURE 1. PEAK CURRENT AND ENERGY DERATING CURVE

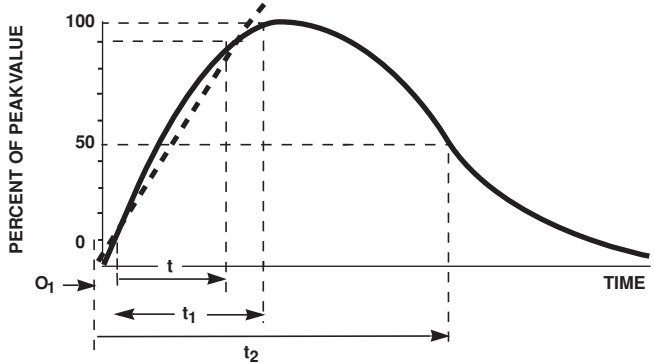

FIGURE 2. PEAK PULSE CURRENT TEST WAVEFORM FOR CLAMPING VOLTAGE

O<sub>1</sub> = VIRTUAL ORIGIN OF WAVE  
 t = TIME FROM 10% TO 90% OF PEAK  
 t<sub>1</sub> = VIRTUAL FRONT TIME = 1.25 x t  
 t<sub>2</sub> = VIRTUAL TIME TO HALF VALUE (IMPULSE DURATION)

EXAMPLE:  
 FOR AN 8/20μS CURRENT WAVEFORM  
 8μS = t<sub>1</sub> = VIRTUAL FRONT TIME  
 20μS = t<sub>2</sub> = VIRTUAL TIME TO HALF VALUE

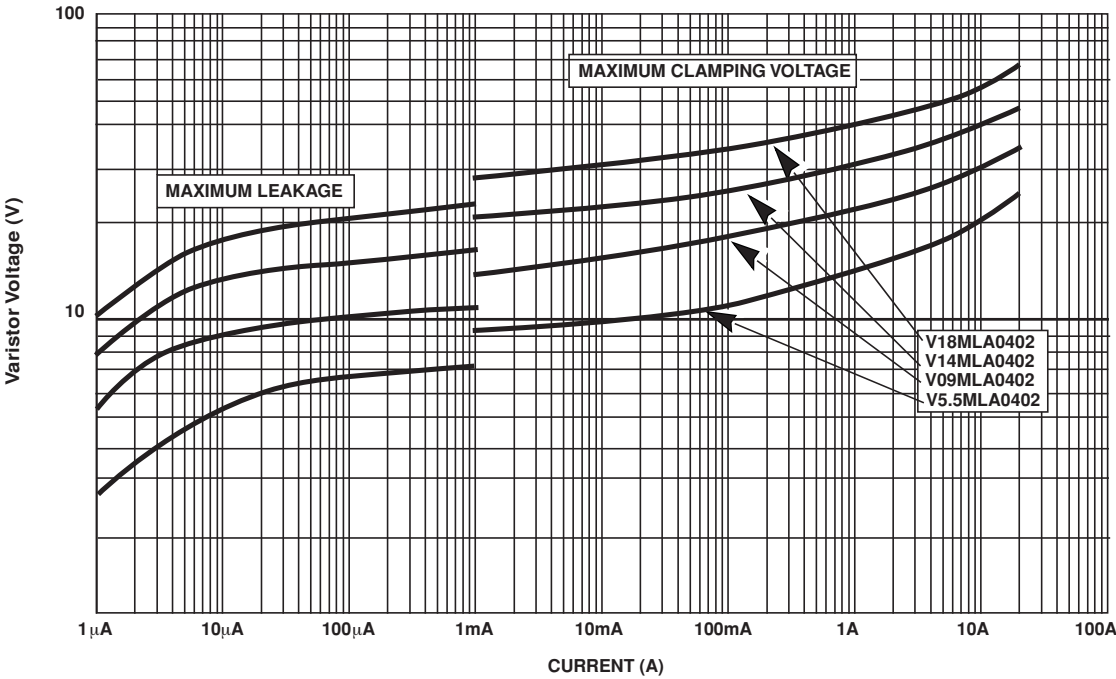

FIGURE 3. LIMIT V-I CHARACTERISTIC FOR V5.5MLA0402 TO V18MLA0402

SURFACE MOUNT VARISTORS

# Surface Mount Varistors

Multilayer Transient Voltage Surge Suppressors

## ML Varistor Series

### Maximum Transient V-I Characteristic Curves

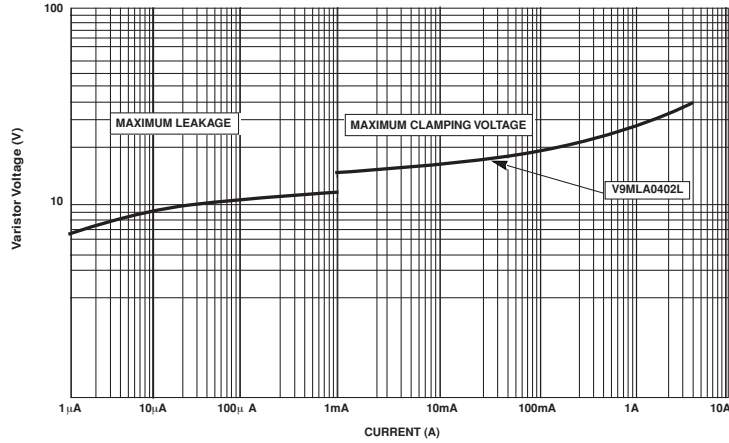

FIGURE 4. LIMIT V-I CHARACTERISTIC FOR V9MLA0402L

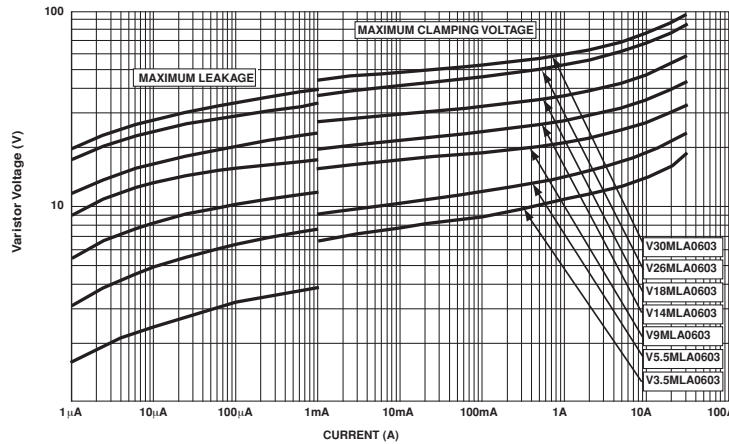

FIGURE 5. LIMIT V-I CHARACTERISTIC FOR V3.5MLA0603 TO V30MLA0603

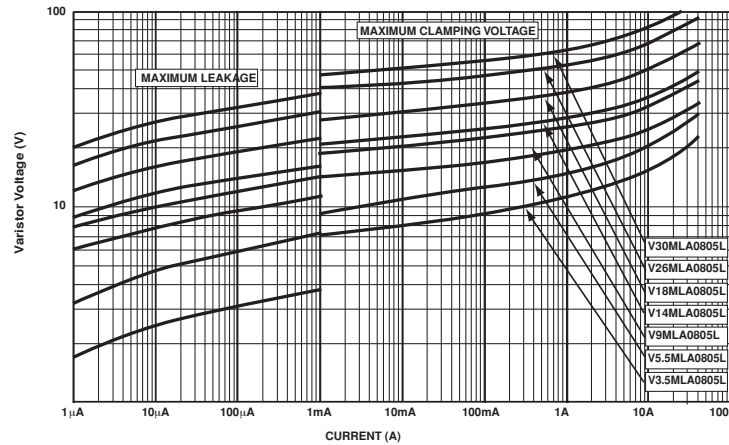

FIGURE 6. LIMIT V-I CHARACTERISTIC FOR V3.5MLA0805L TO V30MLA0805L

**ML Varistor Series**

**Maximum Transient V-I Characteristic Curves** (Continued)

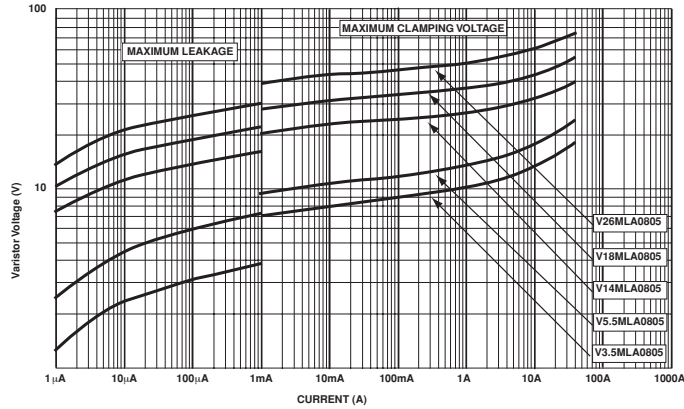

FIGURE 7. LIMIT V-I CHARACTERISTIC FOR V3.5MLA0805 TO V26MLA0805

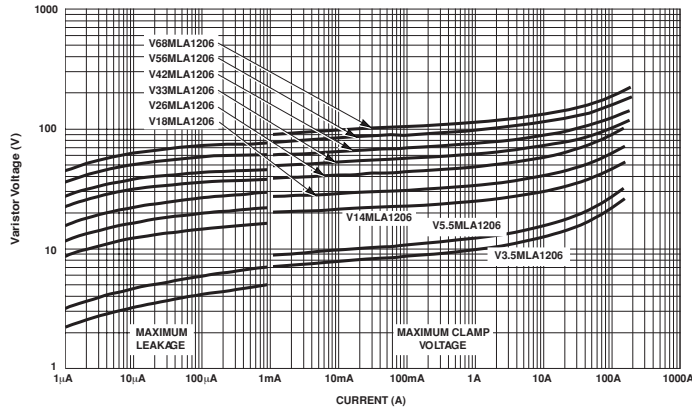

FIGURE 8. LIMIT V-I CHARACTERISTIC FOR V3.5MLA1206 TO V68MLA1206

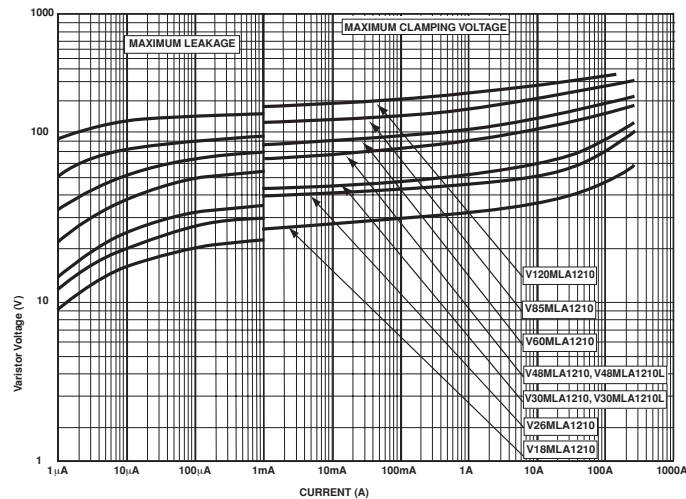

FIGURE 9. LIMIT V-I CHARACTERISTIC FOR V18MLA1210 TO V120MLA1210

# Surface Mount Varistors

## Multilayer Transient Voltage Surge Suppressors

### ML Varistor Series

#### Device Characteristics

At low current levels, the V-I curve of the multilayer transient voltage suppressor approaches a linear (ohmic) relationship and shows a temperature dependent effect (Figure 10). At or below the maximum working voltage, the suppressor is in a high resistance mode (approaching  $10^6\Omega$  at its maximum rated working voltage). Leakage currents at maximum rated voltage are below  $50\mu\text{A}$ , typically  $25\mu\text{A}$ ; for 0402 size below  $10\mu\text{A}$ , typically  $5\mu\text{A}$ .

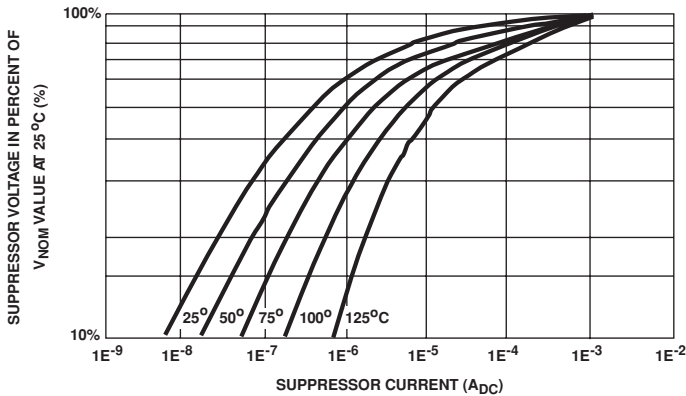

FIGURE 10. TYPICAL TEMPERATURE DEPENDANCE OF THE CHARACTERISTIC CURVE IN THE LEAKAGE REGION

#### Speed of Response

The Multilayer Suppressor is a leadless device. Its response time is not limited by the parasitic lead inductances found in other surface mount packages. The response time of the Zinc Oxide dielectric material is less than 1 nanosecond and the ML can clamp very fast dV/dT events such as ESD. Additionally, in “real world” applications, the associated circuit wiring is often the greatest factor effecting speed of response. Therefore, transient suppressor placement within a circuit can be considered important in certain instances.

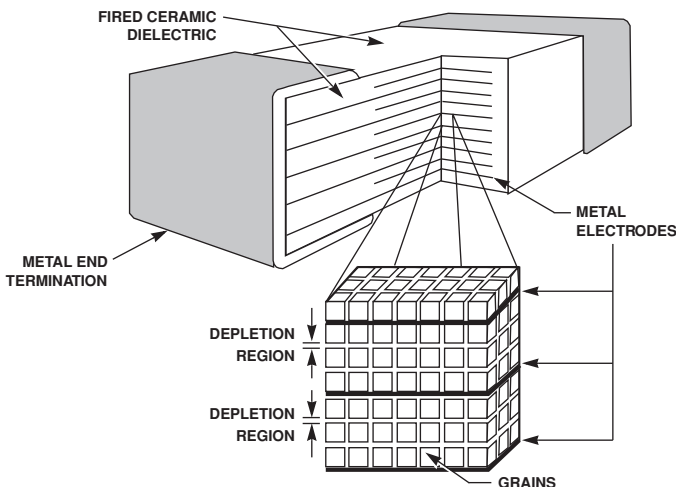

FIGURE 11. MULTILAYER INTERNAL CONSTRUCTION

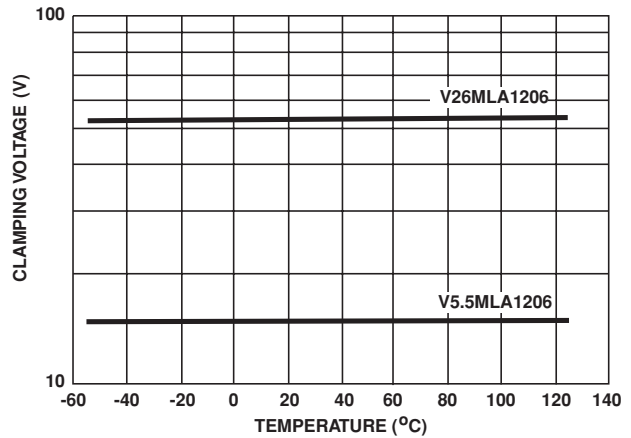

FIGURE 12. CLAMPING VOLTAGE OVER TEMPERATURE ( $V_C$  AT 10A)

#### Energy Absorption/Peak Current Capability

Energy dissipated within the ML is calculated by multiplying the clamping voltage, transient current and transient duration. An important advantage of the multilayer is its interdigitated electrode construction within the mass of dielectric material. This results in excellent current distribution and the peak temperature per energy absorbed is very low. The matrix of semiconducting grains combine to absorb and distribute transient energy (heat) (Figure 11). This dramatically reduces peak temperature; thermal stresses and enhances device reliability.

As a measure of the device capability in energy and peak current handling, the V26MLA1206A part was tested with multiple pulses at its peak current rating ( $150\text{A}$ ,  $8/20\mu\text{s}$ ). At the end of the test, 10,000 pulses later, the device voltage characteristics are still well within specification (Figure 13).

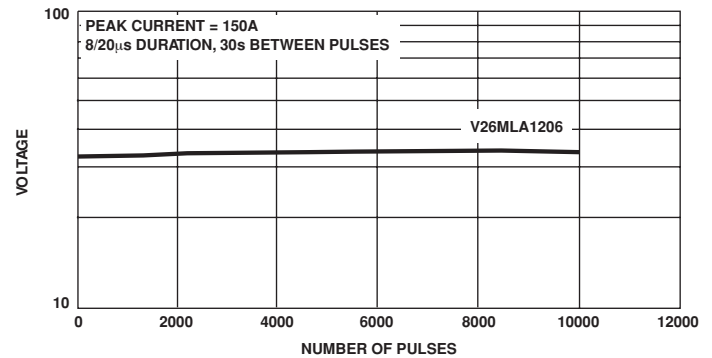

FIGURE 13. REPETITIVE PULSE CAPABILITY

# ML Varistor Series

## Soldering Recommendations

The principal techniques used for the soldering of components in surface mount technology are Infrared (IR) re-flow, vapour phase re-flow and wave soldering. Typical profiles are shown in Figures 14, 15 and 16. When wave soldering, the ML suppressor is attached to the circuit board by means of an adhesive. The assembly is then placed on a conveyor and run through the soldering process to contact the wave. With IR and vapour phase reflow; the device is placed in a solder paste on the substrate. As the solder paste is heated, it re-flows and solders the unit to the board.

The recommended solder for the ML suppressor is a 62/36/2 (Sn/Pb/Ag), 60/40 (Sn/Pb) or 63/37 (Sn/Pb). Littelfuse also recommends an RMA solder flux.

Wave soldering is the most strenuous of the processes. To avoid the possibility of generating stresses due to thermal shock, a preheat stage in the soldering process is recommended, and the peak temperature of the solder process should be rigidly controlled. For 0402 size devices, IR re-flow is recommended.

When using a reflow process, care should be taken to ensure that the ML chip is not subjected to a thermal gradient steeper than 4 degrees per second; the ideal gradient being 2 degrees per second. During the soldering process, preheating to within 100 degrees of the solder's peak temperature is essential to minimize thermal shock. Examples of the soldering conditions for the ML suppressor are given in the tables below.

Once the soldering process has been completed, it is still necessary to ensure that any further thermal shocks are avoided. One possible cause of thermal shock is hot printed circuit boards being removed from the solder process and subjected to cleaning solvents at room temperature. The boards must be allowed to cool gradually to less than 50°C before cleaning.

## Termination Options

Littelfuse offers three types of electrode termination finish for the Multilayer product series:

- 1. Silver/Platinum (standard, not available for 0402)
- 2. Silver/Palladium (optional)  
(The ordering information section describes how to designate them.)
- 3. Nickel Barrier (optional for 0402-1210 package size)  
(The ordering information section describes how to designate them.)

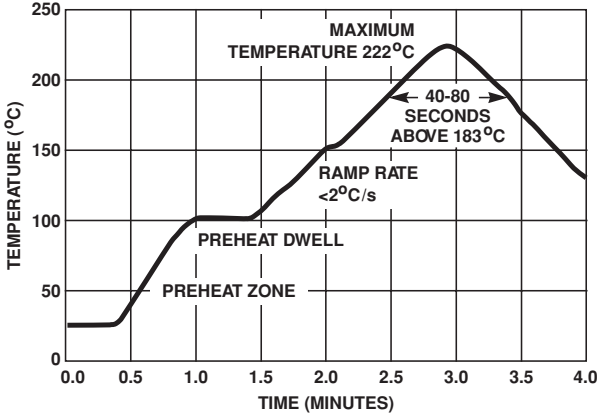

FIGURE 14. REFLOW SOLDER PROFILE

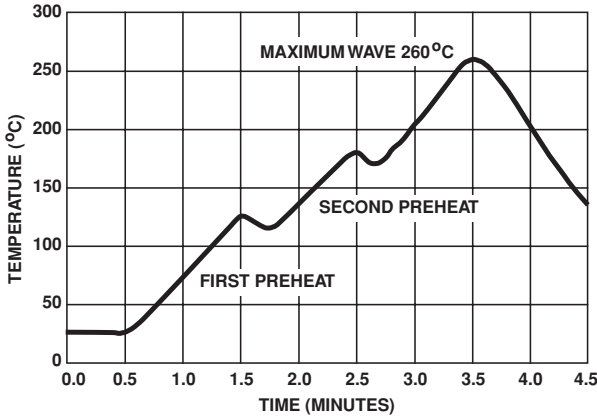

FIGURE 15. WAVE SOLDER PROFILE

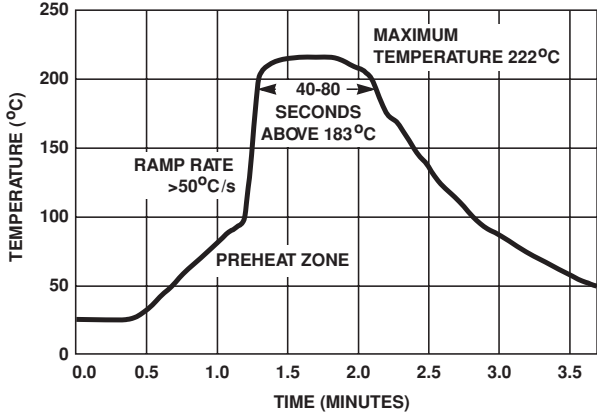

FIGURE 16. VAPOR PHASE SOLDER PROFILE

# Surface Mount Varistors

Multilayer Transient Voltage Surge Suppressors

## ML Varistor Series

### Recommended Pad Outline

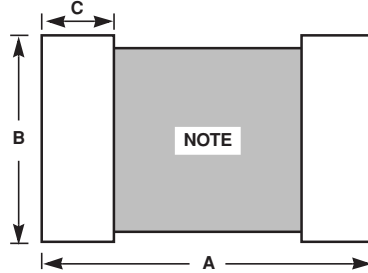

NOTE: Avoid metal runs in this area.

TABLE 1: PAD LAYOUT DIMENSIONS

DIMENSION	PAD SIZE									
	1210 SIZE DEVICE		1206 SIZE DEVICE		0805 SIZE DEVICE		0603 SIZE DEVICE			
	IN	MM	IN	MM	IN	MM	IN	MM	IN	MM
A	0.160	4.06	0.160	4.06	0.120	3.05	0.100	2.54	0.067	1.70
B	0.100	2.54	0.065	1.65	0.050	1.27	0.030	0.76	0.020	0.51
C	0.040	1.02	0.040	1.02	0.040	1.02	0.035	0.89	0.024	0.61



### ML Varistor Series

#### Mechanical Dimensions

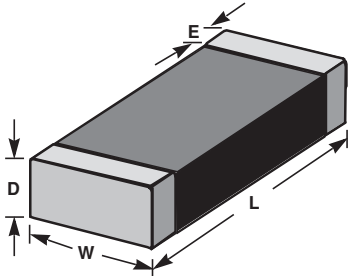

DIMENSION	CHIP SIZE									
	1210		1206		0805		0603		0402	
	IN	MM	IN	MM	IN	MM	IN	MM	IN	MM
D Max.	0.113	2.87	0.071	1.80	0.043	1.10	0.035	0.90	0.024	0.61
E	0.02 ±0.01	0.50 ±0.25	0.02 ±0.01	0.50 ±0.25	0.01 to 0.029	0.50 to 0.25	0.015 ±0.008	0.4 ±0.2	0.010 ±0.006	0.25 ±0.15
L	0.125 ±0.012	3.20 ±0.30	0.125 ±0.012	3.20 ±0.30	0.079 ±0.008	2.01 ±0.20	0.063 ±0.006	1.6 ±0.15	0.039 ±0.004	1.0 ±0.1
W	0.10 ±0.012	2.54 ±0.30	0.06 ±0.011	1.60 ±0.28	0.049 ±0.008	1.25 ±0.20	0.032 ±0.06	0.8 ±0.15	0.020 ±0.004	0.5 ±0.1

#### Ordering Information

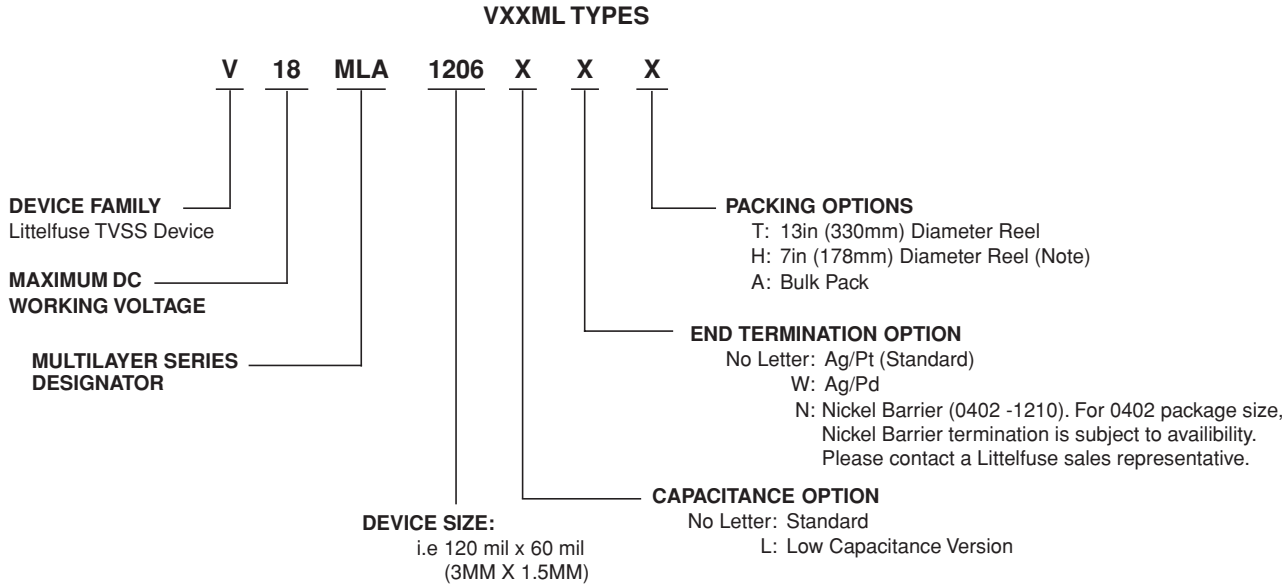

#### Standard Shipping Quantities

DEVICE SIZE	"13" INCH REEL ("T" OPTION)	"7" INCH REEL ("H" OPTION)	BULK PACK ("A" OPTION)
1210	8,000	2,500	2500
1206	10,000	2,500	2500
0805	10,000	2,500	2500
0603	10,000	2,500	2500
0402	N/A	10,000	N/A

# Surface Mount Varistors

## Multilayer Transient Voltage Surge Suppressors

### ML Varistor Series

#### Tape and Reel Specifications

- Conforms to EIA - 481-1, Revision A
- Can be supplied to IEC Publication 286 - 3

SYMBOL	DESCRIPTION	DIMENSIONS IN MILLIMETERS	
		0402 Size	0603, 0805, 1206 & 1210 Sizes
A <sub>0</sub>	Width of Cavity	Dependent on Chip Size to Minimize Rotation.	
B <sub>0</sub>	Length of Cavity	Dependent on Chip Size to Minimize Rotation.	
K <sub>0</sub>	Depth of Cavity	Dependent on Chip Size to Minimize Rotation.	
W	Width of Tape	8 ±0.2	
F	Distance Between Drive Hole Centers and Cavity Centers	3.5 ±0.05	
E	Distance Between Drive Hole Centers and Tape Edge	1.75 ±0.1	
P <sub>1</sub>	Distance Between Cavity Centers	2±0.05	4 ±0.1
P <sub>2</sub>	Axial Drive Distance Between Drive Hole Centers & Cavity Centers	2 ±0.1	
P <sub>0</sub>	Axial Drive Distance Between Drive Hole Centers	4 ±0.1	
D <sub>0</sub>	Drive Hole Diameter	1.55 ±0.05	
D <sub>1</sub>	Diameter of Cavity Piercing	N/A	1.05 ±0.05
T <sub>1</sub>	Top Tape Thickness	0.1 Max	

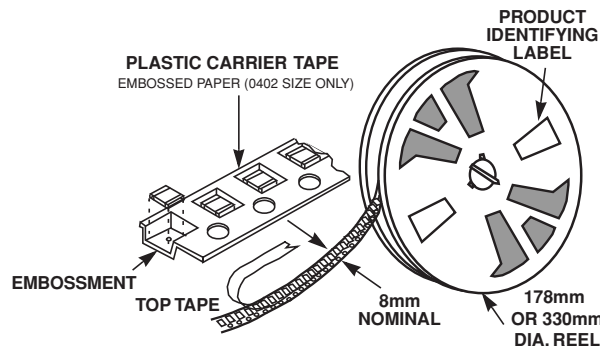
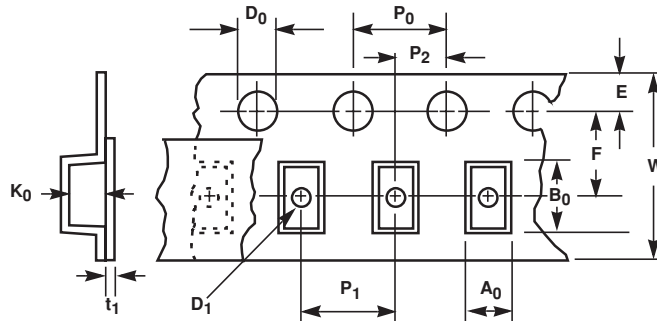

# Mouser Electronics

Authorized Distributor

Click to View Pricing, Inventory, Delivery & Lifecycle Information:

## Littelfuse:

[V14MLA0805LWT](#) [V12MLA0805LWA](#) [V18MLA0805WA](#) [V42MLA1206WH](#) [V5.5MLA0603WH](#) [V56MLA1206WA](#)  
[V3.5MLA0805LWA](#) [V5.5MLA0805WA](#) [V30MLA0603WH](#) [V48MLA1210LWA](#) [V9MLA0603WA](#) [V5.5MLA0805WH](#)  
[V3.5MLA0603WA](#) [V26MLA0805WA](#) [V3.5MLA0603WH](#) [V26MLA1210WA](#) [V42MLA1206WA](#) [V9MLA0603WH](#)  
[V120MLA1210WA](#) [V68MLA1206WA](#) [V33MLA1206WA](#) [V5.5MLA0603WA](#) [V18MLA0805LWH](#) [V30MLA0805LWA](#)  
[V3.5MLA1206WA](#) [V14MLA0603WA](#) [V5.5MLA1206WA](#) [V18MLA1210WA](#) [V68MLA1206WH](#) [V30MLA1210WA](#)  
[V18MLA0805WH](#) [V5.5MLA0805LWH](#) [V5.5MLA1206WH](#) [V30MLA1210LWA](#) [V18MLA1206WA](#) [V26MLA1206WT](#)  
[V26MLA0603WA](#) [V56MLA1206WH](#) [V26MLA1206WA](#) [V14MLA0805WA](#) [V18MLA0603WA](#) [V5.5MLA0603WT](#)  
[V33MLA1206WH](#) [V14MLA0805WT](#) [V26MLA0805LWA](#) [V85MLA1210WA](#) [V14MLA0805LWA](#) [V14MLA1206WH](#)  
[V26MLA1206WH](#) [V5.5MLA0805LWA](#) [V9MLA0805LWA](#) [V18MLA0805LWA](#) [V48MLA1210WA](#) [V3.5MLA0805WA](#)  
[V60MLA1210WA](#) [V14MLA0805LWH](#) [V14MLA1206WA](#) [V14MLA0603WH](#) [V18MLA1206WH](#) [V30MLA0603WA](#)  
[V18MLA1210LWA](#) [V48MLA1210WH](#)