

1 Characteristics

Table 1. Absolute maximum ratings ($T_{amb} = 25\text{ }^{\circ}\text{C}$)

Symbol	Parameter		Value	Unit
V_{PP}	Peak pulse voltage	IEC 61000-4-2: Contact discharge	8	kV
		Air discharge	20	
		MIL STD 883G - method 3015-7: Class3	25	
P_{PP}	Peak pulse power	8/20 μs , T_j initial = T_{amb}	30	W
T_{stg}	Storage temperature range		-55 to +150	$^{\circ}\text{C}$
T_j	Junction temperature range		-40 to +150	
T_L	Maximum lead temperature for soldering during 10 s		260	
T_{op}	Operating temperature range		-40 to +150	

Figure 1. Electrical characteristics (definitions)

Symbol	Parameter
V_{BR}	= Breakdown voltage
V_{CL}	= Clamping voltage
I_{RM}	= Leakage current
I_F	= Forward current
I_{PP}	= Peak pulse current
I_R	= Breakdown current
V_F	= Forward voltage drop
C	= Capacitance
R_d	= Dynamic impedance
αT	= Voltage temperature

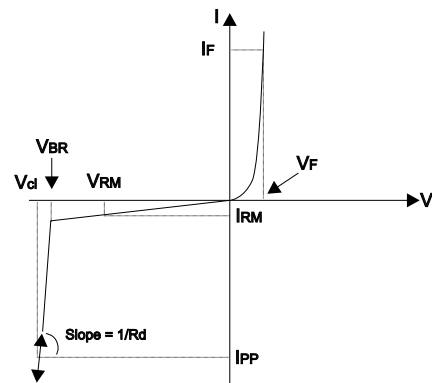
Table 2. Electrical characteristics ($T_{amb} = 25\text{ }^{\circ}\text{C}$)

Order code	V_{BR} at I_R		I_{RM} at V_{RM}			R_d	αT	C	
	Min.	Max.	Typ.	Max.		Typ.	Typ.	Typ. at 3 V	
	V	V	mA	nA	μA	V	Ω	$10^{-4}/^{\circ}\text{C}$	pF
ESDALC6V1P5	6.1	7.2	1	10	0.1	3	1.5	4.5	7.5
ESDALC6V1P6		8.0							

1.1 Characteristics (curves)

Figure 2. Peak pulse power dissipation versus initial junction temperature

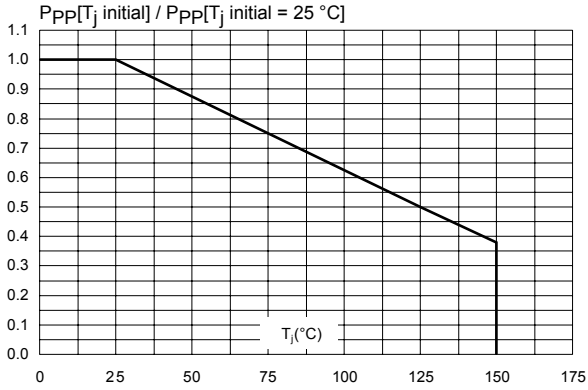

Figure 3. Peak pulse power versus exponential pulse duration (T_j initial = 25 °C)

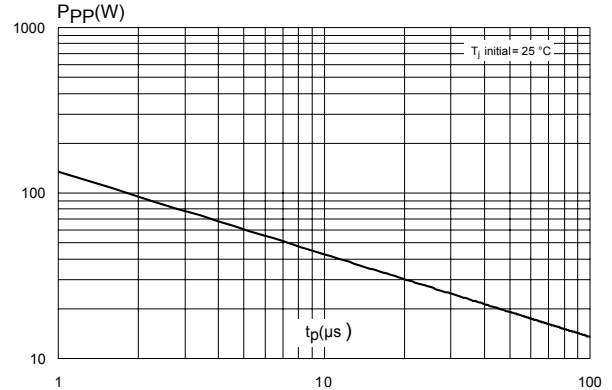

Figure 4. Clamping voltage versus peak pulse current (rectangular waveform)

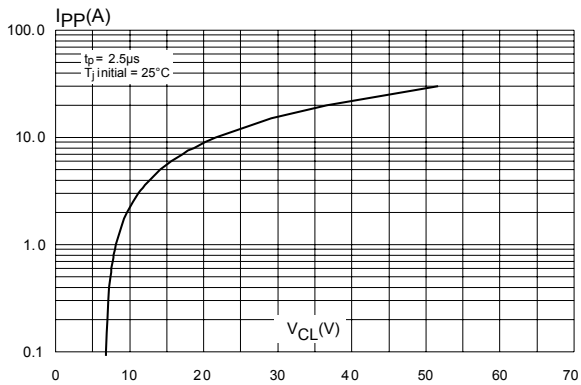

Figure 5. Forward voltage drop versus peak forward current

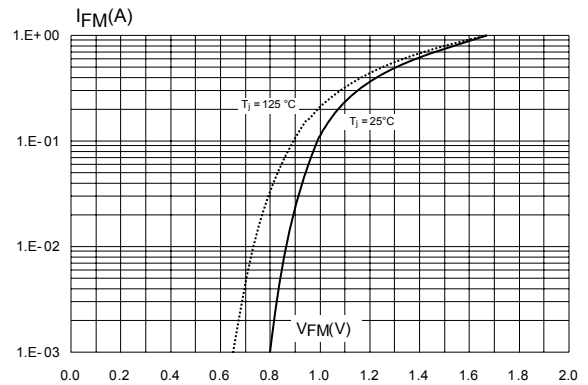

Figure 6. Junction capacitance versus reverse applied voltage

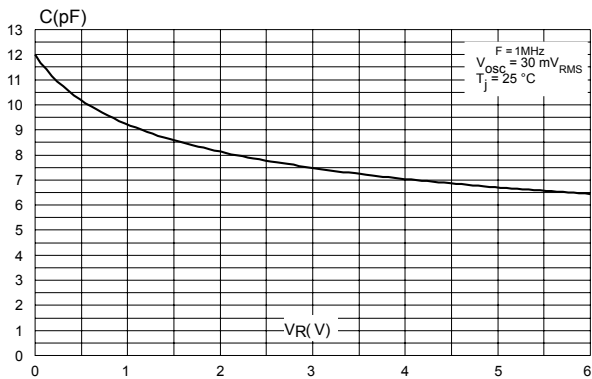

Figure 7. Relative variation of leakage current versus junction temperature

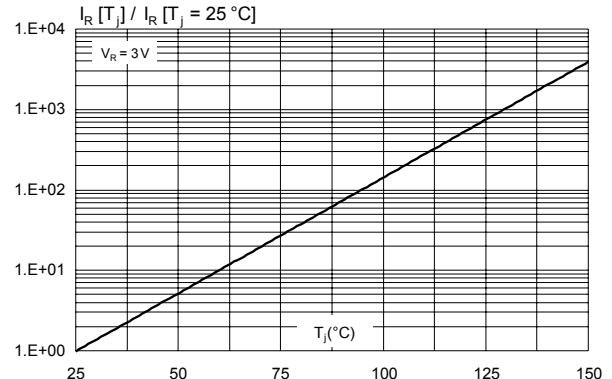

Figure 8. ESD response to IEC 61000-4-2 (+15 kV air discharge)

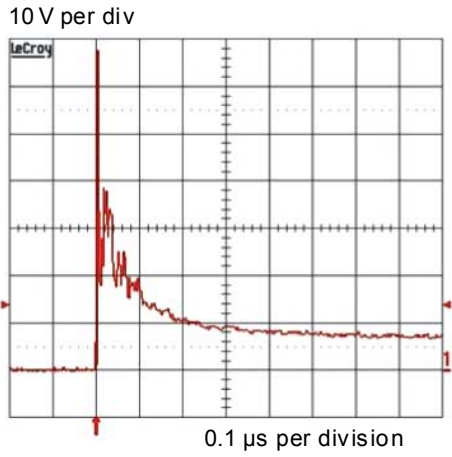

Figure 9. Analog crosstalk

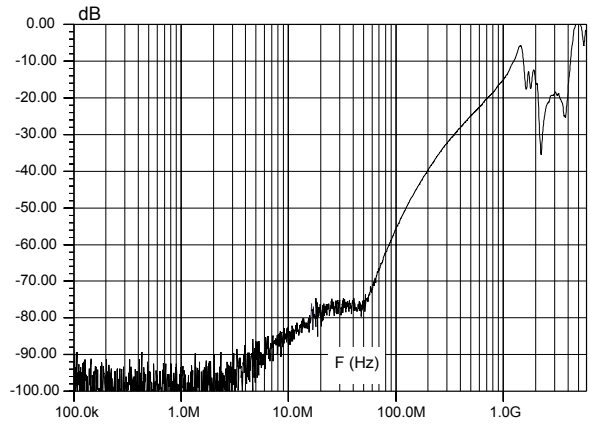
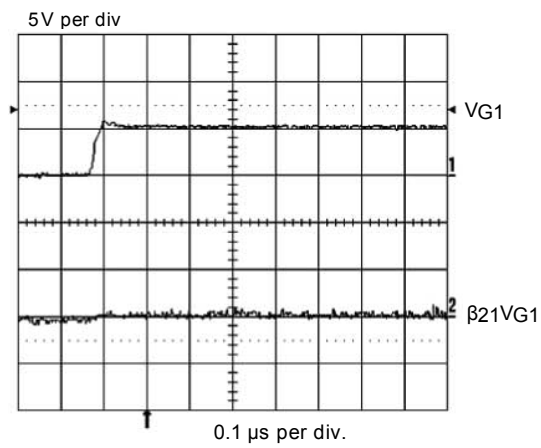

Figure 10. Digital crosstalk test



2 Package information

In order to meet environmental requirements, ST offers these devices in different grades of **ECOPACK** packages, depending on their level of environmental compliance. ECOPACK specifications, grade definitions and product status are available at: www.st.com. ECOPACK is an ST trademark.

2.1 SOT-665 package information

Figure 11. SOT-665 package outline

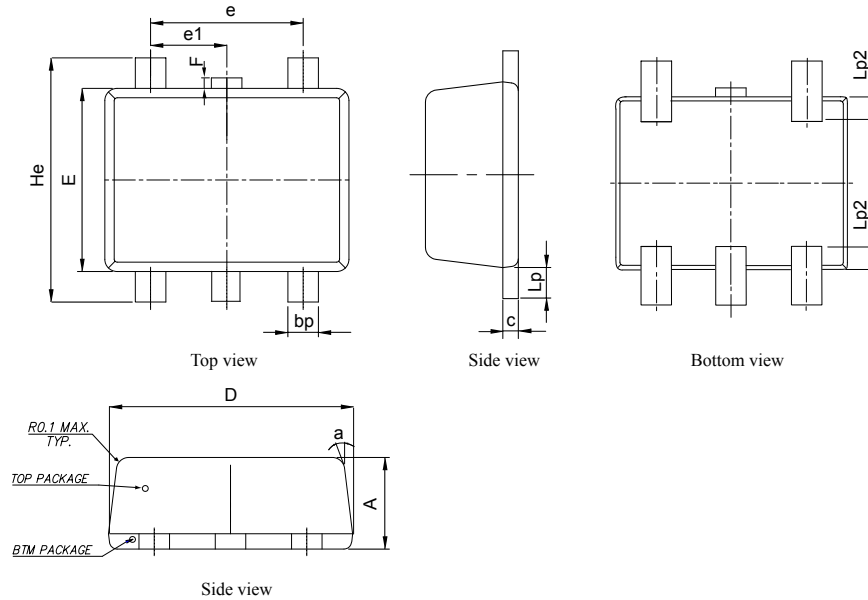

Table 3. SOT-665 package mechanical data

Ref.	Dimensions					
	Millimeters			Inches		
	Min.	Typ.	Max.	Min.	Typ.	Max.
A	0.50		0.62	0.019		0.025
bp	0.17	0.20	0.34	0.006	0.008	0.014
C	0.08		0.18	0.003		0.008
D	1.50		1.70	0.059		0.067
E	1.10		1.30	0.043		0.052
e1		0.50			0.020	
e		1.00			0.039	
F	0.00		0.10	0.000		0.004
He	1.50		1.70	0.059		0.067
Lp	0.10		0.30	0.003		0.012
Lp2		0.15			0.006	

Figure 12. Footprint recommendations, dimensions in mm

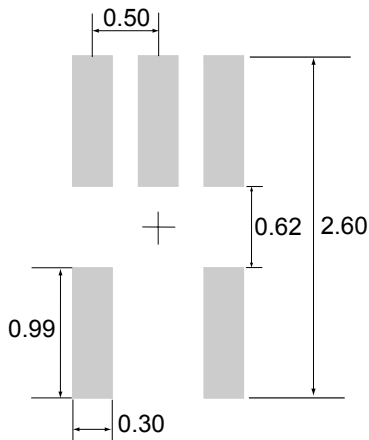

Figure 13. Marking layout (refer to ordering information table for marking)

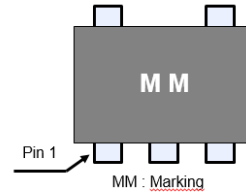
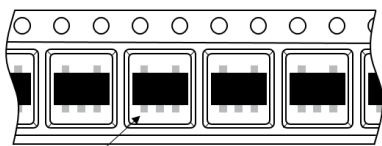

Figure 14. Package orientation in reel



Pin 1 located according to EIA-481

Note:
Pocket dimensions are not on scale
Pocket shape may vary depending on package

Figure 15. Tape and reel orientation

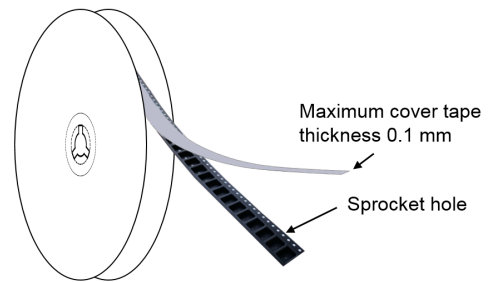

Figure 16. Reel dimensions (mm)

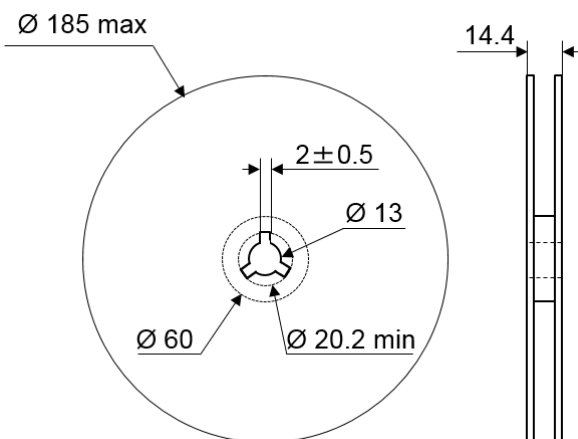

Figure 17. Inner box dimensions (mm)

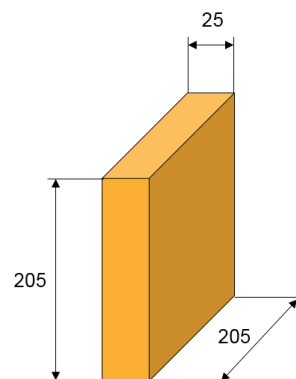
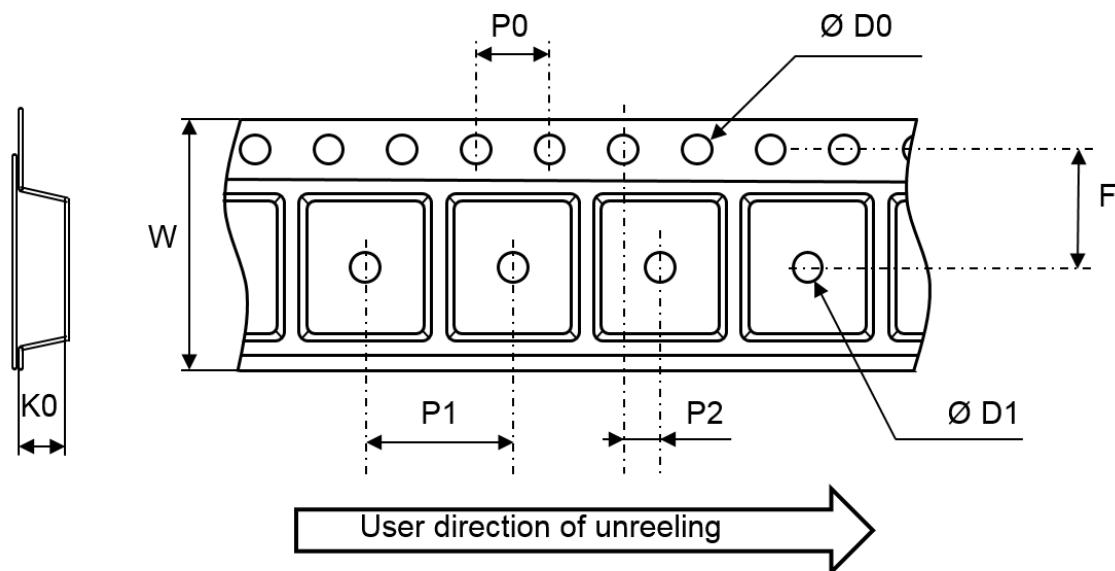

Figure 18. Tape and reel outline



Note: Pocket dimensions are not on scale
Pocket shape may vary depending on package

Table 4. Tape and reel mechanical data

Ref.	Dimensions		
	Millimeters		
	Min.	Typ.	Max.
D0	1.5	1.55	1.6
D1	1		
F	3.45	3.5	3.55
K0	0.64	0.69	0.73
P0	3.9	4	4.1
P1	3.9	4	4.1
P2	1.95	2	2.05
W	7.9	8	8.3

2.2 SOT-666IP package information

Figure 19. SOT-666IP package outline

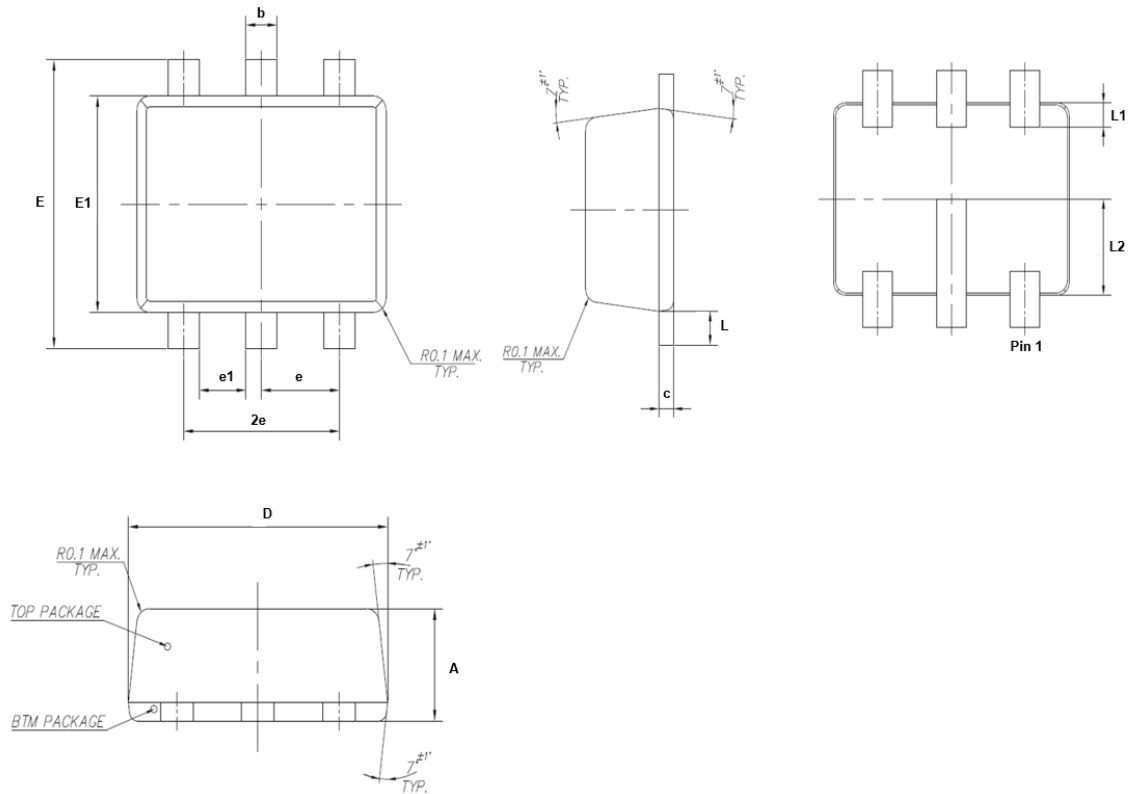

Table 5. SOT-666IP package mechanical data

Ref.	Dimensions					
	Millimeters			Inches		
	Min.	Typ.	Max.	Min.	Typ.	Max.
A	0.50	0.60	0.62	0.019	0.024	0.025
b	0.17	0.20	0.34	0.006	0.008	0.014
c	0.08	0.15	0.18	0.003	0.006	0.008
D	1.50	1.60	1.70	0.059	0.063	0.067
E	1.50	1.60	1.70	0.059	0.063	0.067
e	0.45	0.50	0.55	0.017	0.020	0.022
E1	1.10	1.20	1.30	0.043	0.047	0.052
e1		0.25			0.10	
L	0.10	0.20	0.30	0.003	0.008	0.012
L1	0.05	0.15	0.25	0.001	0.006	0.010
L2	0.50	0.60	0.70	0.019	0.024	0.028

Figure 20. Footprint recommendations, dimensions in mm

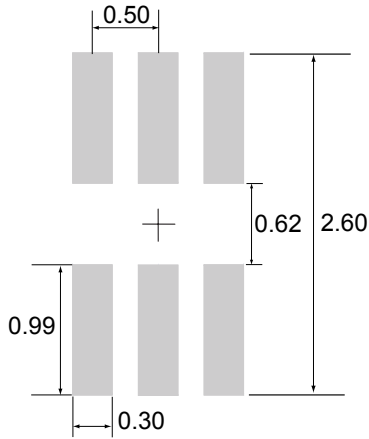

Figure 21. Marking layout (refer to ordering information table for marking)

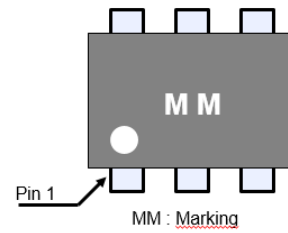
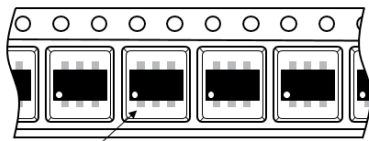

Figure 22. Package orientation in reel



Note: Pin 1 located according to EIA-481
Pocket dimensions are not on scale
Pocket shape may vary depending on package

Figure 23. Tape and reel orientation

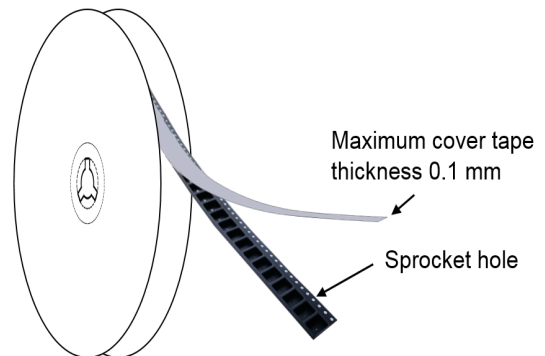

Figure 24. Reel dimensions (mm)

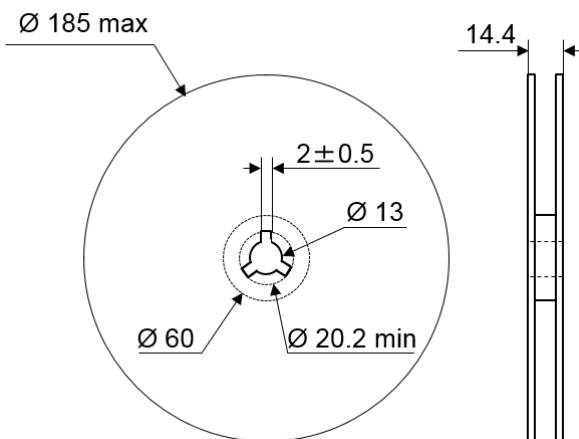

Figure 25. Inner box dimensions (mm)

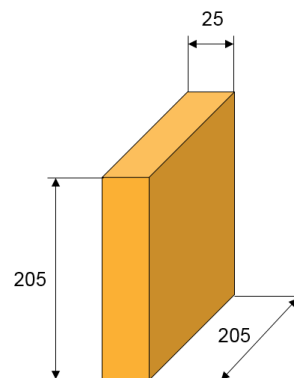
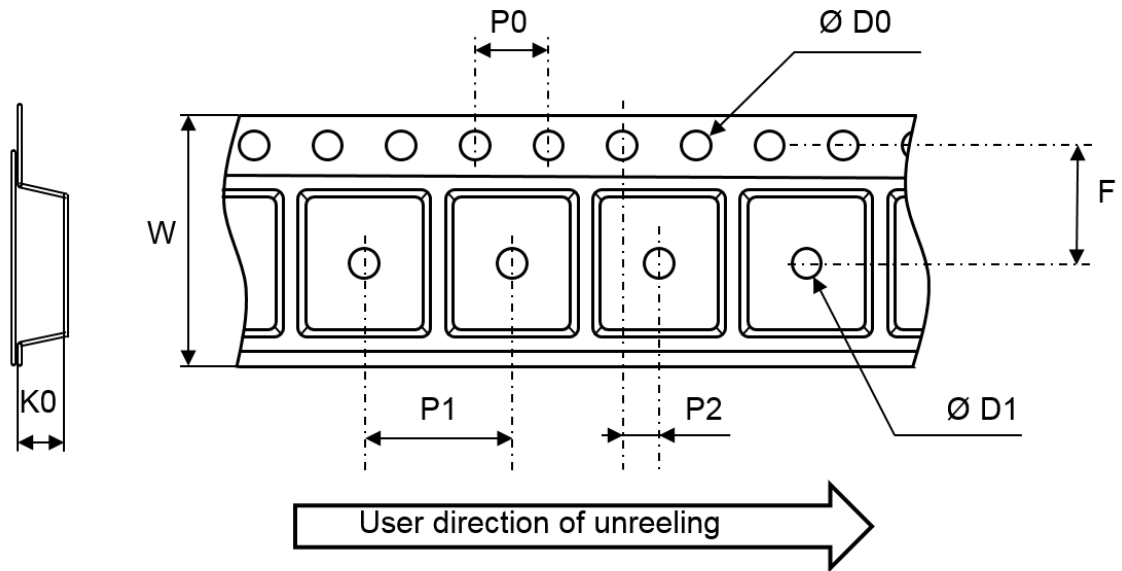

Figure 26. Tape and reel outline



Note: Pocket dimensions are not on scale
Pocket shape may vary depending on package

Table 6. Tape and reel mechanical data

Ref.	Dimensions		
	Millimeters		
	Min.	Typ.	Max.
D0	1.5	1.55	1.6
D1	1		
F	3.45	3.5	3.55
K0	0.64	0.69	0.73
P0	3.9	4	4.1
P1	3.9	4	4.1
P2	1.95	2	2.05
W	7.9	8	8.3

2.3 Reflow profile

Figure 27. ST ECOPACK® recommended soldering reflow profile for PCB mounting

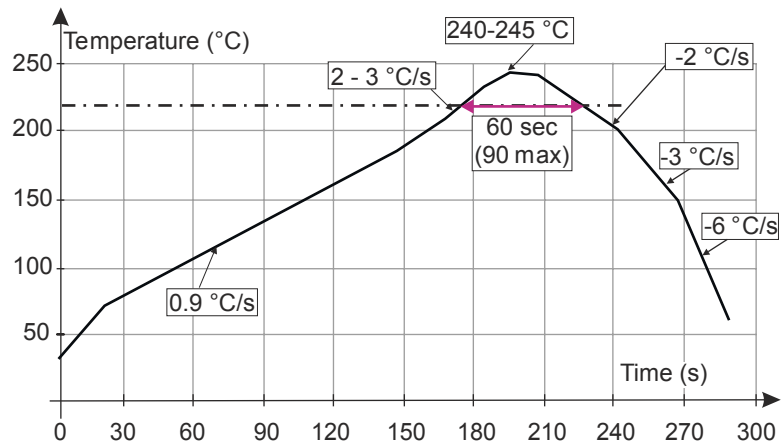

Note: Minimize air convection currents in the reflow oven to avoid component movement.

Note: Maximum soldering profile corresponds to the latest IPC/JEDEC J-STD-020.

3 Ordering information

Figure 28. Ordering information scheme

Table 7. Ordering information

Order code	Marking ⁽¹⁾	Package	Weight	Base qty.	Delivery mode
ESDALC6V1P5	A1	SOT-665	3.53 mg	3000	Tape and reel
ESDALC6V1P6	D	SOT-666IP	3.0 mg		

1. The marking can be rotated by multiples of 90° to differentiate assembly location

Revision history

Table 8. Document revision history

Date	Revision	Changes
16-Aug-2006	1	ESDALC6V1P3, ESDALC6V1P5, and ESDALC6V1P6 merged and reformatted to current standards.
23-Aug-2006	2	Table 1 on page 2: Temperature range upgraded to $T_j \text{ max} = 150 \text{ }^\circ\text{C}$
11-Oct-2006	3	Added values for V_{PP} in Table 1.
23-Apr-2008	4	Reformatted to current standards. Added I_{RM} typical value in Table 2. Update minimum dimension for L2 of SOT-663 in Table 3.
15-Jan-2010	5	Updated Figure 17: SOT-665 footprint (dimensions in mm).
03-Dec-2014	6	Updated SOT-666IP dimension definitions and reformatted to current standard.
17-Mar-2017	7	Removed SOT-663 package. Updated Table 1. Absolute maximum ratings ($T_{amb} = 25 \text{ }^\circ\text{C}$). Updated Table 3. SOT-665 package mechanical data and Table 4. SOT-666IP package mechanical data.
03-Aug-2017	8	Updated Section 2.1 SOT-665 package information.
26-Mar-2018	9	Updated Table 3. SOT-665 package mechanical data. Updated cover page.
13-May-2019	10	Updated Section Features, Section Applications, Table 1, Table 2 and Section 2 .

IMPORTANT NOTICE – PLEASE READ CAREFULLY

STMicroelectronics NV and its subsidiaries (“ST”) reserve the right to make changes, corrections, enhancements, modifications, and improvements to ST products and/or to this document at any time without notice. Purchasers should obtain the latest relevant information on ST products before placing orders. ST products are sold pursuant to ST’s terms and conditions of sale in place at the time of order acknowledgement.

Purchasers are solely responsible for the choice, selection, and use of ST products and ST assumes no liability for application assistance or the design of Purchasers’ products.

No license, express or implied, to any intellectual property right is granted by ST herein.

Resale of ST products with provisions different from the information set forth herein shall void any warranty granted by ST for such product.

ST and the ST logo are trademarks of ST. For additional information about ST trademarks, please refer to www.st.com/trademarks. All other product or service names are the property of their respective owners.

Information in this document supersedes and replaces information previously supplied in any prior versions of this document.

© 2019 STMicroelectronics – All rights reserved

Mouser Electronics

Authorized Distributor

Click to View Pricing, Inventory, Delivery & Lifecycle Information:

[STMicroelectronics:](#)

[ESDALC6V1P5](#) [ESDALC6V1P6](#)