

## RATING AND CHARACTERISTIC CURVES (CPDH5-5V0U-HF)

Fig. 1 - 8/20us Peak pulse current waveform acc. IEC 61000-4-5

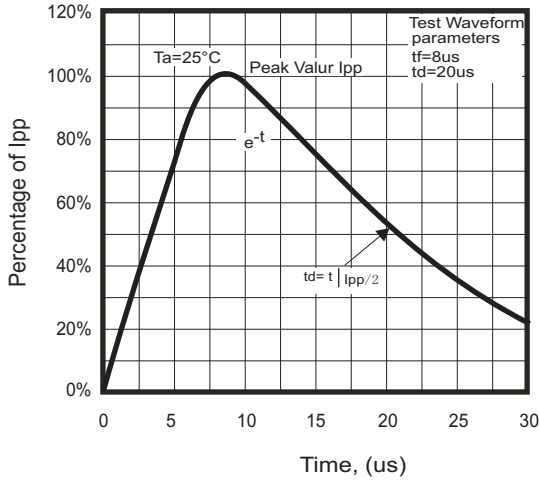

Fig.2 - Power rating derating curve

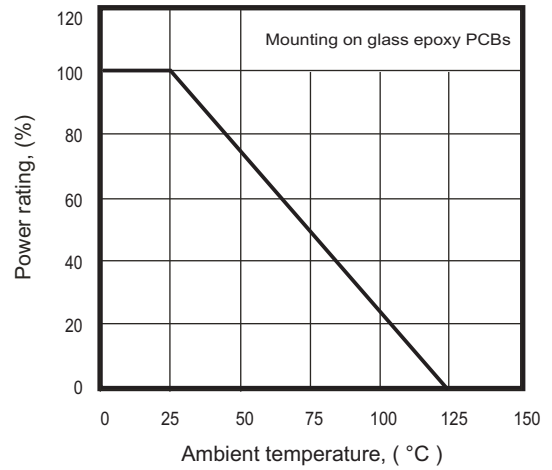

Fig.3 - Clamping voltage vs. peak pulse current

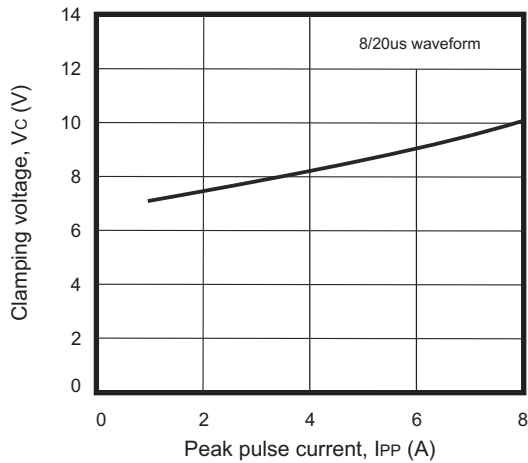
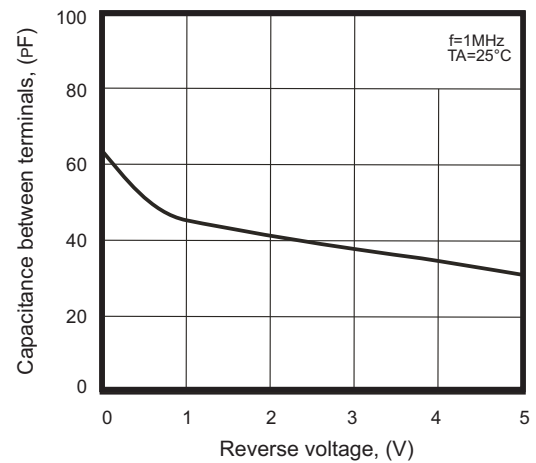
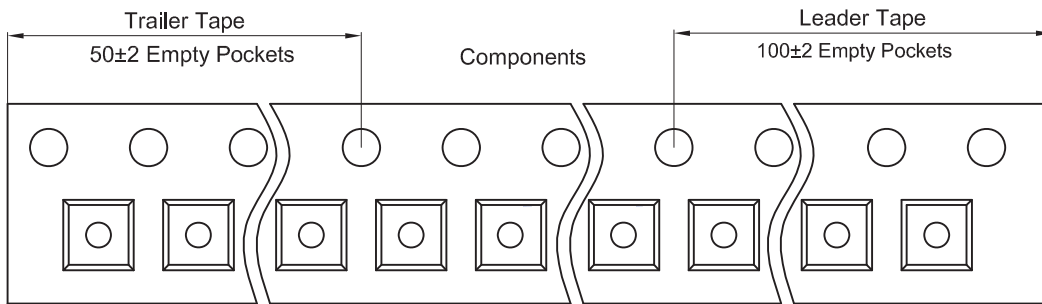
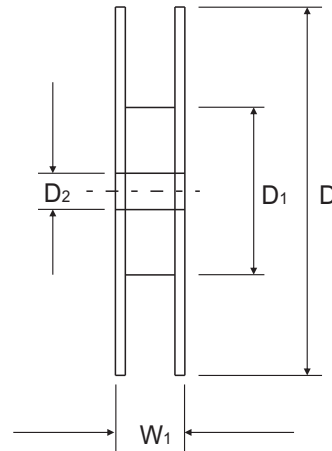
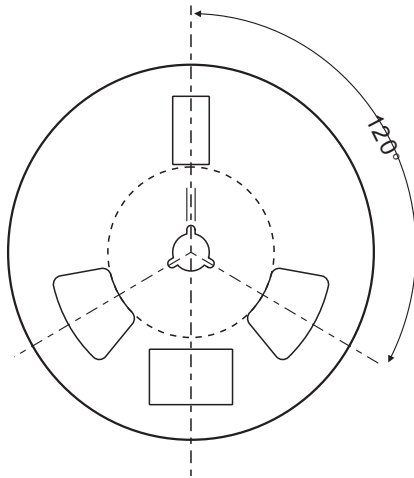
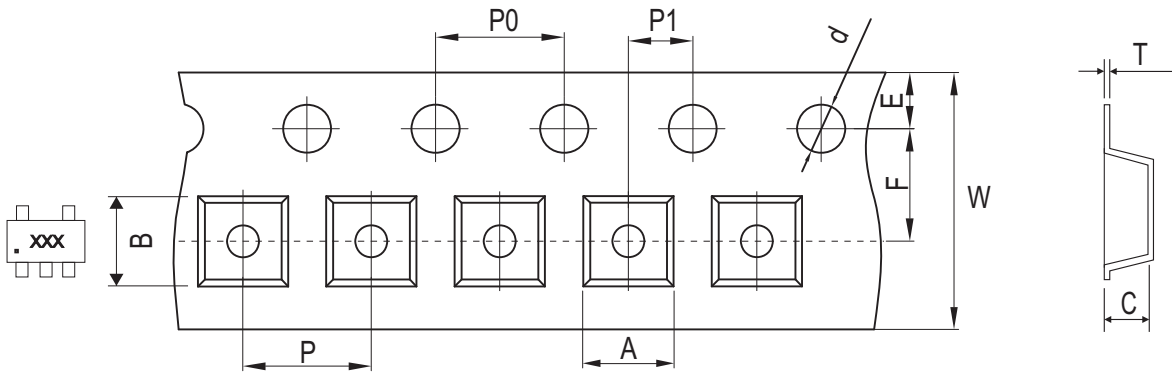

Fig.4 - Capacitance between terminals characteristics



## Reel Taping Specification



| SOT-553 | SYMBOL | A             | B             | C             | d             | D             | D1            | D2            |
|---------|--------|---------------|---------------|---------------|---------------|---------------|---------------|---------------|
|         | (mm)   | 1.78 ± 0.10   | 1.78 ± 0.10   | 0.69 ± 0.10   | 1.50 ± 0.10   | 178 ± 2.00    | 54.4 ± 1.00   | 13.0 ± 1.00   |
|         | (inch) | 0.070 ± 0.004 | 0.070 ± 0.004 | 0.027 ± 0.004 | 0.059 ± 0.004 | 7.008 ± 0.079 | 2.142 ± 0.040 | 0.512 ± 0.040 |

| SOT-553 | SYMBOL | E             | F             | P             | P0            | P1            | W             | W1            |
|---------|--------|---------------|---------------|---------------|---------------|---------------|---------------|---------------|
|         | (mm)   | 1.75 ± 0.10   | 3.50 ± 0.05   | 4.00 ± 0.10   | 4.00 ± 0.10   | 2.00 ± 0.10   | 8.00 ± 0.10   | 12.30 ± 1.00  |
|         | (inch) | 0.069 ± 0.004 | 0.138 ± 0.002 | 0.157 ± 0.004 | 0.157 ± 0.004 | 0.079 ± 0.002 | 0.315 ± 0.004 | 0.567 ± 0.040 |

## Marking Code

| Part Number   | Marking Code |
|---------------|--------------|
| CPDH5-5V0U-HF | E5U          |

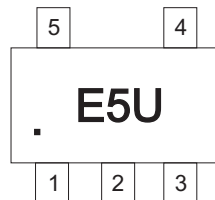

## Suggested PAD Layout

| SIZE | SOT-553 |        |
|------|---------|--------|
|      | (mm)    | (inch) |
| A    | 0.30    | 0.012  |
| B    | 0.30    | 0.012  |
| C    | 1.00    | 0.039  |
| D    | 1.40    | 0.055  |
| E    | 1.70    | 0.067  |
| F    | 0.50    | 0.020  |

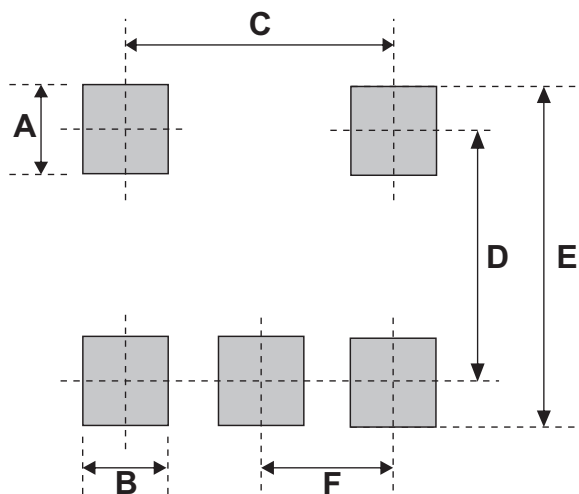

## Standard Packaging

| Case Type | REEL PACK    |                  |
|-----------|--------------|------------------|
|           | REEL ( pcs ) | Reel Size (inch) |
| SOT-553   | 3,000        | 7                |

# Mouser Electronics

Authorized Distributor

Click to View Pricing, Inventory, Delivery & Lifecycle Information:

[Comchip Technology:](#)

[CPDH5-5V0U-HF](#)