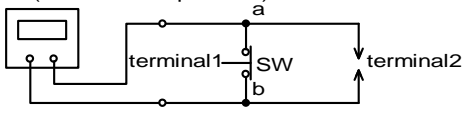
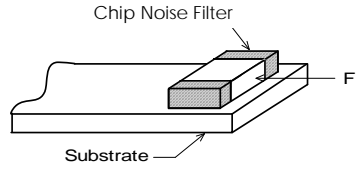
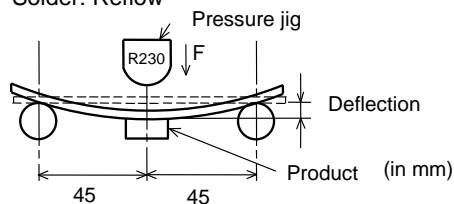

6. Electrical Performance

No.	Item	Specification	Test Method
6.1	Impedance	Impedance shall meet item 3.	Measuring Equipment: KEYSIGHT 4991A or equivalent (1mA) Measuring Frequency: 100MHz
6.2	DC Resistance	DC Resistance shall meet item 3.	Measuring Equipment: Digital multi meter Digital multi meter (TR6846 or equivalent)  <div style="border: 1px solid black; padding: 5px; width: fit-content;"> DC resistance shall be measured after putting chip noise filter between the terminal 2 under the condition of opening between a and b. Every measurement the terminal 1 shall be shorted between a and b when changing noise filter. </div>

7. Mechanical Performance

No.	Item	Specification	Test Method
7.1	Shear Test	Chip noise filter shall not be damaged after tested as follows.	Applied Direction  Force: 10N Hold Duration: 5s±1s Applied Direction: Parallel to PCB
7.2	Bending Test		Substrate: Glass-epoxy substrate (100mm × 40mm × 1.0mm) Solder: Reflow  Speed of Applying Force: 0.5mm / s Deflection: 2mm Hold Duration: 30 s
7.3	Vibration		Oscillation Frequency: 10Hz to 2000Hz to 10Hz for 20 min Total amplitude 3.0 mm or Acceleration amplitude 245m/s ² whichever is smaller. Testing Time: A period of 4h in each of 3 mutually perpendicular directions.
7.4	Drop		It shall be dropped on concrete or steel board. Method : free fall Height : 1m Total of 10 cycles

No.	Item	Specification	Test Method
7.5	Solderability	The wetting area of the electrode shall be at least 90% covered with new solder coating.	Flux: Ethanol solution of rosin 25(wt)% (Immersed for 5s to 10s) Solder: Sn-3.0Ag-0.5Cu Pre-Heating: 150°C±10°C / 60s to 90s Solder Temperature: 240°C±5°C Immersion Time: 3s±1s
7.6	Resistance to Soldering Heat	Appearance: No damage Impedance Change: within ±30%	Flux: Ethanol solution of rosin 25(wt)% (Immersed for 5s to 10s) Solder: Sn-3.0Ag-0.5Cu Pre-Heating: 150°C±10°C / 60s to 90s Solder Temperature: 270°C±5°C Immersion Time: 10s±1s Then measured after exposure in the room condition for 24h±2h.

8. Environmental Performance

It shall be soldered on the substrate.

No.	Item	Specification	Test Method
8.1	Heat Resistance	Appearance: No damage Impedance Change: within ±30%	Temperature: 85°C±2°C Time: 1000h (+48h,-0h) Then measured after exposure in the room condition for 24h±2h.
8.2	Cold Resistance		Temperature: -40°C±2°C Time: 1000h (+48h,-0h) Then measured after exposure in the room condition for 24h±2h.
8.3	Humidity		Temperature: 40°C±2°C Humidity: 90%(RH) to 95%(RH) Time: 1000h (+48h,-0h) Then measured after exposure in the room condition for 24h±2h.
8.4	Temperature Cycle		1 cycle: 1 step: -40°C±2°C / 30 min±3 min 2 step: Ordinary temp. / 10 min to 15 min 3 step: 85°C±2°C / 30 min to 3 min 4 step: Ordinary temp. / 10 min to 15 min Total of 100cycles Then measured after exposure in the room condition for 24h±2h.

9. Specification of Packaging

9.1 Appearance and Dimensions of plastic tape (8mm-wide)

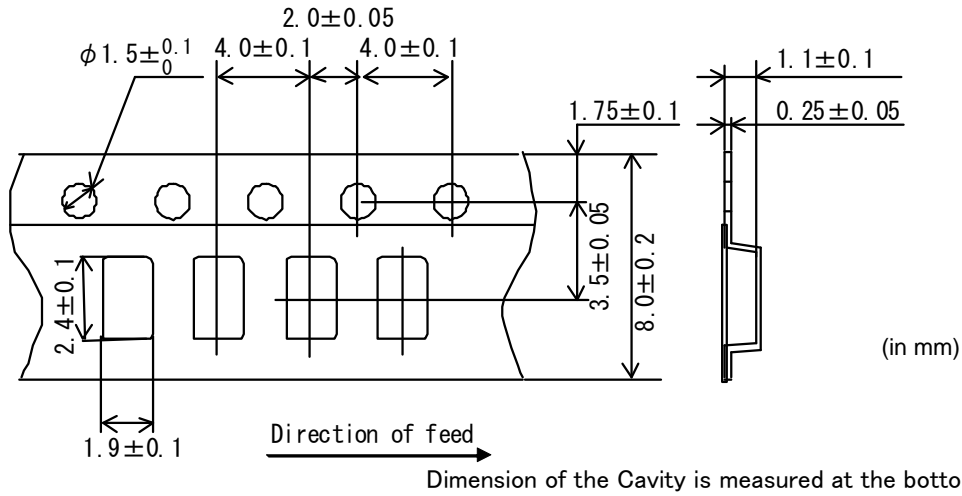

9.2 Specification of Taping

- (1) Packing quantity (standard quantity)
3,000 pcs / reel
- (2) Packing Method
Products shall be packed in the each embossed cavity of plastic tape and sealed by cover tape.
- (3) Sprocket hole
The sprocket holes are to the right as the tape is pulled toward the user.
- (4) Spliced point
Plastic tape and Cover tape has no spliced point.
- (5) Missing components number
Missing components number within 0.1% of the number per reel or 1 pc., whichever is greater, and are not continuous. The Specified quantity per reel is kept.

9.3 Pull Strength

Plastic tape	10N min.
Cover tape	5N min.

9.4 Peeling off force of cover tape

Speed of Peeling off	300mm / min
Peeling off force	Plastic tape: 0.1N to 0.7N (minimum value is typical)

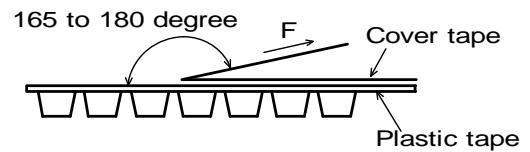

9.5 Dimensions of Leader-tape, Trailer and Reel

There shall be leader-tape (cover tape) and trailer-tape (empty tape) as follows.

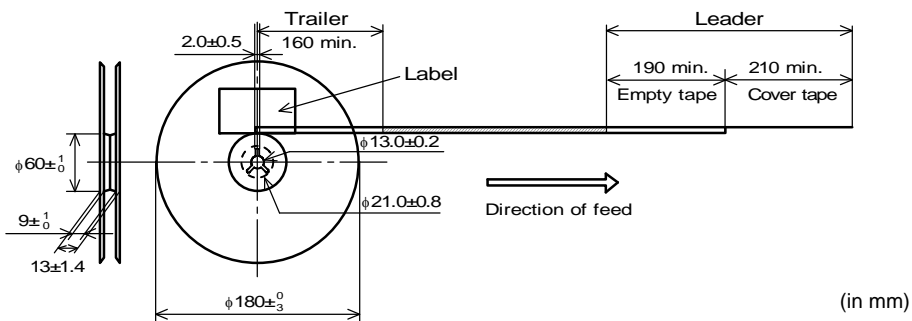

9.6 Marking for reel

Customer part number, MURATA part number, Inspection number (*1), RoHS marking (*2), Quantity etc ...

*1) <Expression of Inspection No.>

□□ 0000 ×××
 (1) (2) (3)

- (1) Factory Code
- (2) Date First digit : Year / Last digit of year
 Second digit : Month / Jan. to Sep. → 1 to 9, Oct. to Dec. → O, N, D
 Third, Fourth digit : Day
- (3) Serial No.

*2) <Expression of RoHS marking >

ROHS - Y (Δ)
 (1) (2)

- (1) RoHS regulation conformity parts.
- (2) MURATA classification number

9.7 Marking for Outside package (corrugated paper box)

Customer name, Purchasing order number, Customer part number, MURATA part number, RoHS marking (*2), Quantity, etc ...

9.8 Specification of Outer Case

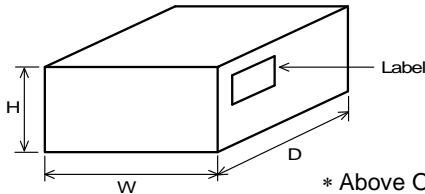

Outer Case Dimensions (mm)			Standard Reel Quantity in Outer Case (Reel)
W	D	H	
186	186	93	5

* Above Outer Case size is typical. It depends on a quantity of an order

10. ⚠ Caution

Limitation of Applications

Please contact us before using our products for the applications listed below which require especially high reliability for the prevention of defects which might directly cause damage to the third party's life, body or property.

- | | |
|-----------------------------------|--|
| (1) Aircraft equipment | (6) Transportation equipment (vehicles, trains, ships, etc.) |
| (2) Aerospace equipment | (7) Traffic signal equipment |
| (3) Undersea equipment | (8) Disaster prevention / crime prevention equipment |
| (4) Power plant control equipment | (9) Data-processing equipment |
| (5) Medical equipment | (10) Applications of similar complexity and /or reliability requirements to the applications listed in the above |

11. Notice

This product is designed for solder mounting.
 Please consult us in advance for applying other mounting method such as conductive adhesive.

11.1 Land pattern designing

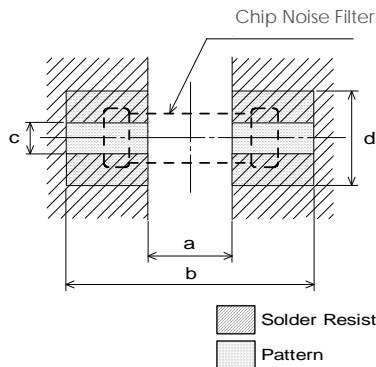

Operating Current (A)	a	b	c	Land pad thickness and dimension d		
				18μm	35μm	70μm
0 to 1.5	0.8	2.4	1.8	1.8	1.8	1.8
1.5 to 2.5				2.4	1.8	1.8
2.5 to 5.0				5.0	2.4	1.8

(in mm)

11.2 Flux, Solder

- Use rosin-based flux.
- Don't use highly acidic flux with halide content exceeding 0.2(wt) % (chlorine conversion value).
- Don't use water-soluble flux.
- Use Sn-3.0Ag-0.5Cu solder.
- Standard thickness of solder paste: 100 μm to 150 μm.

11.3 Reflow soldering conditions

- Pre-heating should be in such a way that the temperature difference between solder and product surface is limited to 150°C max. Cooling into solvent after soldering also should be in such a way that the temperature difference is limited to 100°C max. Insufficient pre-heating may cause cracks on the product, resulting in the deterioration of products quality.
- Standard soldering profile and the limit soldering profile is as follows. The excessive limit soldering conditions may cause leaching of the electrode and/or resulting in the deterioration of product quality.

Soldering Profile for Lead Free solder

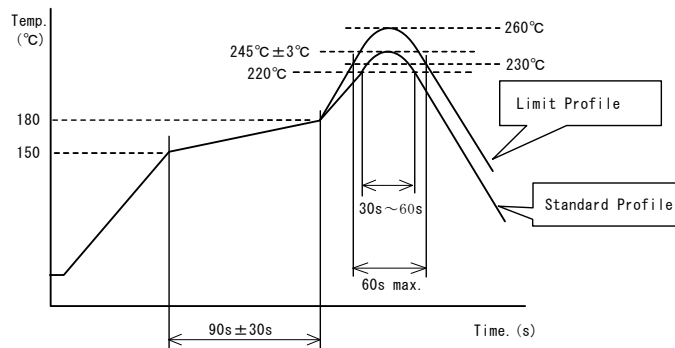

	Standard Profile	Limit Profile
Pre-heating	150°C~180°C, 90s±30s	
Heating	above 220°C, 30s~60s	above 230°C, 60s max.
Peak temperature	245°C±3°C	260°C, 10s
Cycle of reflow	2 times	

11.4 Reworking with soldering iron

Soldering iron

The following conditions must be strictly followed when using a soldering iron.

Pre-heating	150°C, 1 min
Tip temperature	350°C max.
Soldering iron output	80W max.
Tip diameter	φ3mm max.
Soldering time	3(+1, -0)s
Time	2 times

Note : Do not directly touch the products with the tip of the soldering iron in order to prevent the crack on the products due to the thermal shock.

11.5 Solder Volume

- Solder shall be used not to be exceeded the upper limits as shown below.
- Accordingly increasing the solder volume, the mechanical stress to Chip is also increased. Exceeding solder volume may cause the failure of mechanical or electrical performance.

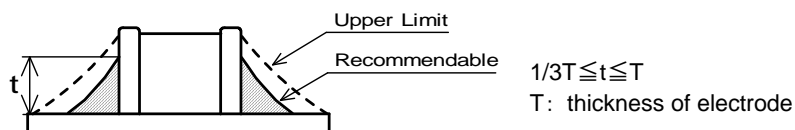

11.6 Product's location

The following shall be considered when designing and laying out P.C.B.'s.

- (1) P.C.B. shall be designed so that products are not subject to the mechanical stress due to warping the board.

[Products direction]

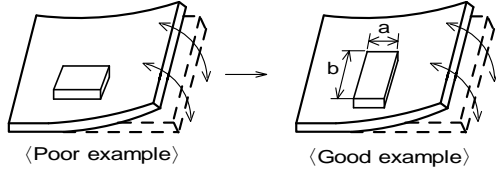

Products shall be located in the sideways direction (Length: a\b) to the mechanical stress.

- (2) Components location on P.C.B. separation.

It is effective to implement the following measures, to reduce stress in separating the board. It is best to implement all of the following three measures; however, implement as many measures as possible to reduce stress.

Contents of Measures	Stress Level
(1) Turn the mounting direction of the component parallel to the board separation surface.	A > D *1
(2) Add slits in the board separation part.	A > B
(3) Keep the mounting position of the component away from the board separation surface.	A > C

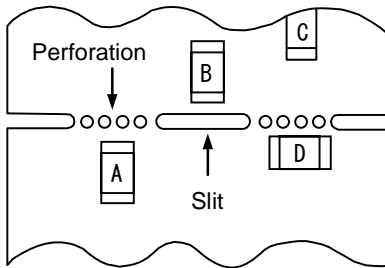

*1 A > D is valid when stress is added vertically to the perforation as with Hand Separation. If a Cutting Disc is used, stress will be diagonal to the PCB, therefore A > D is invalid.

- (3) Mounting Components Near Screw Holes

When a component is mounted near a screw hole, it may be affected by the board deflection that occurs during the tightening of the screw. Mount the component in a position as far away from the screw holes as possible.

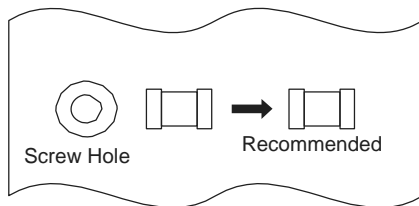

11.7 Cleaning Conditions

Products shall be cleaned on the following conditions.

- (1) Cleaning temperature shall be limited to 60°C max. (40°C max for IPA.)
- (2) Ultrasonic cleaning shall comply with the following conditions with avoiding the resonance phenomenon at the mounted products and P.C.B.
 - Power : 20 W / l max. Frequency : 28kHz to 40kHz Time : 5 min max.
- (3) Cleaner
 - 1. Alcohol type cleaner
Isopropyl alcohol (IPA)
 - 2. Aqueous agent
PINE ALPHA ST-100S

- (4) There shall be no residual flux and residual cleaner after cleaning. In the case of using aqueous agent, products shall be dried completely after rinse with de-ionized water in order to remove the cleaner.
- (5) Other cleaning Please contact us.

11.8 Resin coating

The impedance value may change and/or it may affect on the product's performance due to high cure-stress of resin to be used for coating/molding products. So please pay your careful attention when you select resin.

In prior to use, please make the reliability evaluation with the product mounted in your application set.

11.9 Caution for use

There is possibility that the impedance value change due to magnetism. Don't use a magnet or a pair of tweezers with magnetism when chip noise filters are handled. (The tip of the tweezers should be molded with resin or pottery.)

11.10 Handling of a substrate

After mounting products on a substrate, do not apply any stress to the product caused by bending or twisting to the substrate when cropping the substrate, inserting and removing a connector from the substrate or tightening screw to the substrate.

Excessive mechanical stress may cause cracking in the product.

Bending

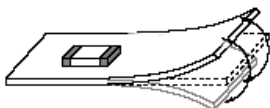

Twisting

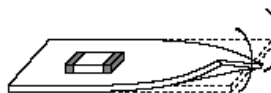

11.11 Storage and Handling Requirements

(1) Storage period

Use the products within 6 months after delivered.

Solderability should be checked if this period is exceeded.

(2) Storage conditions

• Products should be stored in the warehouse on the following conditions.

Temperature : -10°C to 40°C

Humidity : 15% to 85% relative humidity No rapid change on temperature and humidity

Don't keep products in corrosive gases such as sulfur, chlorine gas or acid, or it may cause oxidization of electrode, resulting in poor solderability.

• Products should be stored on the palette for the prevention of the influence from humidity, dust and so on.

• Products should be stored in the warehouse without heat shock, vibration, direct sunlight and so on.

• Products should be stored under the airtight packaged condition.

(3) Handling Condition

Care should be taken when transporting or handling product to avoid excessive vibration or mechanical shock.

12. Note

- (1) Please make sure that your product has been evaluated in view of your specifications with our product being mounted to your product.
- (2) You are requested not to use our product deviating from the reference specifications.
- (3) The contents of this reference specification are subject to change without advance notice.
Please approve our product specifications or transact the approval sheet for product specifications before ordering.

Mouser Electronics

Authorized Distributor

Click to View Pricing, Inventory, Delivery & Lifecycle Information:

[Murata:](#)

[NFZ2MSM601SN10L](#) [NFZ2MSM301SN10L](#) [NFZ2MSM101SN10L](#) [NFZ2MSM181SN10L](#) [NFZ2MSM101SN10D](#)
[NFZ2MSM301SN10D](#) [NFZ2MSM181SN10D](#) [NFZ2MSM601SN10D](#)