

**TABLE OF CONTENTS**

Features .....	1	Output Short-Circuit Performance.....	13
Applications.....	1	Unused Amplifiers .....	13
General Description .....	1	PCB Layout Considerations.....	13
Pin Configurations .....	1	Grounding .....	13
Revision History .....	2	Power Supply Considerations.....	13
Specifications.....	3	Signal Considerations .....	13
Electrical Characteristics .....	3	Phase Reversal .....	14
Wafer Test Limits.....	5	Saturation Recovery Time.....	14
Absolute Maximum Ratings.....	6	High Speed Instrumentation Amplifier .....	14
Thermal Resistance .....	6	2 MHz Biquad Band-Pass Filter .....	15
Dice Characteristics .....	6	Fast I-to-V Converter .....	16
ESD Caution.....	6	OP467 SPICE Marco-Model.....	17
Typical Performance Characteristics .....	7	Outline Dimensions .....	19
Applications Information .....	13	Ordering Guide .....	20

**REVISION HISTORY**

<b>4/10—Rev. H to Rev. I</b>		<b>3/04—Rev. D to Rev. E</b>	
Deleted Endnote 2 From Table 1 .....	3	Changes to TPC 1 .....	5
<b>8/09—Rev. G to Rev. H</b>		Changes to Ordering Guide .....	4
Changes to Table 4.....	6	Updated Outline Dimensions.....	16
<b>4/09—Rev. F to Rev. G</b>		<b>4/01—Rev. C to Rev. D</b>	
Changes to Power Supply Considerations Section.....	13	Footnote added to Power Supply.....	2
<b>5/07—Rev. E to Rev. F</b>		Footnote added to Max Ratings .....	4
Updated Format.....	Universal	Edits to Power Supply Considerations Section.....	11
Changes to General Description .....	1		
Changes to Table 1.....	3		
Changes to Table 2.....	4		
Changes to Table 3.....	5		
Updated Outline Dimensions .....	19		
Changes to Ordering Guide .....	20		

# SPECIFICATIONS

## ELECTRICAL CHARACTERISTICS

@  $V_S = \pm 15.0\text{ V}$ ,  $T_A = 25^\circ\text{C}$ , unless otherwise noted.

Table 1.

Parameter	Symbol	Conditions	Min	Typ	Max	Unit
<b>INPUT CHARACTERISTICS</b>						
Offset Voltage	$V_{OS}$	$-40^\circ\text{C} \leq T_A \leq +85^\circ\text{C}$		0.2	0.5	mV
					1	mV
Input Bias Current	$I_B$	$V_{CM} = 0\text{ V}$		150	600	nA
		$V_{CM} = 0\text{ V}, -40^\circ\text{C} \leq T_A \leq +85^\circ\text{C}$		150	700	nA
Input Offset Current	$I_{OS}$	$V_{CM} = 0\text{ V}$		10	100	nA
		$V_{CM} = 0\text{ V}, -40^\circ\text{C} \leq T_A \leq +85^\circ\text{C}$		10	150	nA
Common-Mode Rejection	CMR	$V_{CM} = \pm 12\text{ V}$	80	90		dB
	CMR	$V_{CM} = \pm 12\text{ V}, -40^\circ\text{C} \leq T_A \leq +85^\circ\text{C}$	80	88		dB
Large Signal Voltage Gain	$A_{VO}$	$R_L = 2\text{ k}\Omega$	83	86		dB
		$R_L = 2\text{ k}\Omega, -40^\circ\text{C} \leq T_A \leq +85^\circ\text{C}$	77.5			dB
Offset Voltage Drift	$\Delta V_{OS}/\Delta T$			3.5		$\mu\text{V}/^\circ\text{C}$
Bias Current Drift	$\Delta I_B/\Delta T$			0.2		$\text{pA}/^\circ\text{C}$
Long-Term Offset Voltage Drift <sup>1</sup>	$\Delta V_{OS}/\Delta T$				750	$\mu\text{V}$
<b>OUTPUT CHARACTERISTICS</b>						
Output Voltage Swing	$V_O$	$R_L = 2\text{ k}\Omega$	$\pm 13.0$	$\pm 13.5$		V
		$R_L = 2\text{ k}\Omega, -40^\circ\text{C} \leq T_A \leq +85^\circ\text{C}$	$\pm 12.9$	$\pm 13.12$		V
<b>POWER SUPPLY</b>						
Power Supply Rejection Ratio	PSRR	$\pm 4.5\text{ V} \leq V_S \leq \pm 18\text{ V}$	96	120		dB
		$-40^\circ\text{C} \leq T_A \leq +85^\circ\text{C}$	86	115		dB
Supply Current	$I_{SY}$	$V_O = 0\text{ V}$		8	10	mA
		$V_O = 0\text{ V}, -40^\circ\text{C} \leq T_A \leq +85^\circ\text{C}$			13	mA
Supply Voltage Range	$V_S$		$\pm 4.5$		$\pm 18$	V
<b>DYNAMIC PERFORMANCE</b>						
Gain Bandwidth Product	GBP	$A_V = +1, C_L = 30\text{ pF}$		28		MHz
Slew Rate	SR	$V_{IN} = 10\text{ V step}, R_L = 2\text{ k}\Omega, C_L = 30\text{ pF}$				
		$A_V = +1$	125	170		$\text{V}/\mu\text{s}$
		$A_V = -1$		350		$\text{V}/\mu\text{s}$
Full-Power Bandwidth	$BW_p$	$V_{IN} = 10\text{ V step}$		2.7		MHz
Settling Time	$t_S$	To 0.01%, $V_{IN} = 10\text{ V step}$		200		ns
Phase Margin	$\theta_0$			45		Degrees
Input Capacitance						
Common Mode				2.0		pF
Differential				1.0		pF
<b>NOISE PERFORMANCE</b>						
Voltage Noise	$e_N\text{ p-p}$	$f = 0.1\text{ Hz to }10\text{ Hz}$		0.15		$\mu\text{V p-p}$
Voltage Noise Density	$e_N$	$f = 1\text{ kHz}$		6		$\text{nV}/\sqrt{\text{Hz}}$
Current Noise Density	$i_N$	$f = 1\text{ kHz}$		0.8		$\text{pA}/\sqrt{\text{Hz}}$

<sup>1</sup> Long-term offset voltage drift is guaranteed by 1000 hrs. Life test performed on three independent wafer lots at  $125^\circ\text{C}$ , with an LTPD of 1.3.

# OP467

@  $V_s = \pm 5.0\text{ V}$ ,  $T_A = 25^\circ\text{C}$ , unless otherwise noted.

**Table 2.**

Parameter	Symbol	Conditions	Min	Typ	Max	Unit
<b>INPUT CHARACTERISTICS</b>						
Offset Voltage	$V_{OS}$	$-40^\circ\text{C} \leq T_A \leq +85^\circ\text{C}$		0.3	0.5	mV
					1	mV
Input Bias Current	$I_B$	$V_{CM} = 0\text{ V}$		125	600	nA
		$V_{CM} = 0\text{ V}, -40^\circ\text{C} \leq T_A \leq +85^\circ\text{C}$		150	700	nA
Input Offset Current	$I_{OS}$	$V_{CM} = 0\text{ V}$		20	100	nA
		$V_{CM} = 0\text{ V}, -40^\circ\text{C} \leq T_A \leq +85^\circ\text{C}$			150	nA
Common-Mode Rejection	CMR	$V_{CM} = \pm 2.0\text{ V}$	76	85		dB
	CMR	$V_{CM} = \pm 2.0\text{ V}, -40^\circ\text{C} \leq T_A \leq +85^\circ\text{C}$	76	80		dB
Large Signal Voltage Gain	$A_{VO}$	$R_L = 2\text{ k}\Omega$	80	83		dB
		$R_L = 2\text{ k}\Omega, -40^\circ\text{C} \leq T_A \leq +85^\circ\text{C}$	74			dB
Offset Voltage Drift	$\Delta V_{OS}/\Delta T$			3.5		$\mu\text{V}/^\circ\text{C}$
Bias Current Drift	$\Delta I_B/\Delta T$			0.2		$\text{pA}/^\circ\text{C}$
<b>OUTPUT CHARACTERISTICS</b>						
Output Voltage Swing	$V_O$	$R_L = 2\text{ k}\Omega$	$\pm 3.0$	$\pm 3.5$		V
		$R_L = 2\text{ k}\Omega, -40^\circ\text{C} \leq T_A \leq +85^\circ\text{C}$	$\pm 3.0$	$\pm 3.20$		V
<b>POWER SUPPLY</b>						
Power Supply Rejection Ratio	PSRR	$\pm 4.5\text{ V} \leq V_s \leq \pm 5.5\text{ V}$	92	107		dB
		$-40^\circ\text{C} \leq T_A \leq +85^\circ\text{C}$	83	105		dB
Supply Current	$I_{SY}$	$V_O = 0\text{ V}$		8	10	mA
		$V_O = 0\text{ V}, -40^\circ\text{C} \leq T_A \leq +85^\circ\text{C}$			12	mA
<b>DYNAMIC PERFORMANCE</b>						
Gain Bandwidth Product	GBP	$A_V = +1$		22		MHz
Slew Rate	SR	$V_{IN} = 5\text{ V step}, R_L = 2\text{ k}\Omega, C_L = 39\text{ pF}$				V/ $\mu\text{s}$
		$A_V = +1$		90		V/ $\mu\text{s}$
		$A_V = -1$		90		V/ $\mu\text{s}$
Full-Power Bandwidth	$BW_p$	$V_{IN} = 5\text{ V step}$		2.5		MHz
Settling Time	$t_s$	To 0.01%, $V_{IN} = 5\text{ V step}$		280		ns
Phase Margin	$\theta_0$			45		Degrees
<b>NOISE PERFORMANCE</b>						
Voltage Noise	$e_N\text{ p-p}$	$f = 0.1\text{ Hz to }10\text{ Hz}$		0.15		$\mu\text{V p-p}$
Voltage Noise Density	$e_N$	$f = 1\text{ kHz}$		7		$\text{nV}/\sqrt{\text{Hz}}$
Current Noise Density	$i_N$	$f = 1\text{ kHz}$		0.8		$\text{pA}/\sqrt{\text{Hz}}$

**WAFER TEST LIMITS<sup>1</sup>**

@  $V_S = \pm 15.0\text{ V}$ ,  $T_A = 25^\circ\text{C}$ , unless otherwise noted.

**Table 3.**

Parameter	Symbol	Conditions	Limit	Unit
Offset Voltage	$V_{OS}$		$\pm 0.5$	mV max
Input Bias Current	$I_B$	$V_{CM} = 0\text{ V}$	600	nA max
Input Offset Current	$I_{OS}$	$V_{CM} = 0\text{ V}$	100	nA max
Input Voltage Range <sup>2</sup>			$\pm 12$	V min/max
Common-Mode Rejection Ratio	CMRR	$V_{CM} = \pm 12\text{ V}$	80	dB min
Power Supply Rejection Ratio	PSRR	$V = \pm 4.5\text{ V to } \pm 18\text{ V}$	96	dB min
Large Signal Voltage Gain	$A_{VO}$	$R_L = 2\text{ k}\Omega$	83	dB min
Output Voltage Range	$V_O$	$R_L = 2\text{ k}\Omega$	$\pm 13.0$	V min
Supply Current	$I_{SY}$	$V_O = 0\text{ V}, R_L = \infty$	10	mA max

<sup>1</sup> Electrical tests and wafer probe to the limits shown. Due to variations in assembly methods and normal yield loss, yield after packaging is not guaranteed for standard product dice. Consult sales to negotiate specifications based on dice lot qualifications through sample lot assembly and testing.

<sup>2</sup> Guaranteed by CMR test.

## ABSOLUTE MAXIMUM RATINGS

Table 4.

Parameter <sup>1</sup>	Rating
Supply Voltage	±18 V
Input Voltage <sup>2</sup>	±18 V
Differential Input Voltage <sup>2</sup>	±26 V
Output Short-Circuit Duration	Limited
Storage Temperature Range	
14-Lead CERDIP and 20-Terminal LCC	−65°C to +175°C
14-Lead PDIP and 16-Lead SOIC	−65°C to +150°C
Operating Temperature Range	
OP467A	−55°C to +125°C
OP467G	−40°C to +85°C
Junction Temperature Range	
14-Lead CERDIP and 20-Terminal LCC	−65°C to +175°C
14-Lead PDIP and 16-Lead SOIC	−65°C to +150°C
Lead Temperature (Soldering, 60 sec)	300°C

<sup>1</sup> Absolute maximum ratings apply to both DICE and packaged parts, unless otherwise noted.

<sup>2</sup> For supply voltages less than ±18 V, the absolute maximum input voltage is equal to the supply voltage.

Stresses above those listed under Absolute Maximum Ratings may cause permanent damage to the device. This is a stress rating only; functional operation of the device at these or any other conditions above those indicated in the operational section of this specification is not implied. Exposure to absolute maximum rating conditions for extended periods may affect device reliability.

### THERMAL RESISTANCE

$\theta_{JA}$  is specified for the worst-case conditions, that is, a device soldered in a circuit board for surface-mount packages.

Table 5.

Package Type	$\theta_{JA}$ <sup>1</sup>	$\theta_{JC}$	Unit
14-Lead CERDIP (Y)	94	10	°C/W
14-Lead PDIP (P)	76	33	°C/W
16-Lead SOIC (S)	88	23	°C/W
20-Terminal LCC (RC)	78	33	°C/W

<sup>1</sup>  $\theta_{JA}$  is specified for the worst-case conditions, that is,  $\theta_{JA}$  is specified for device in socket for CERDIP, PDIP, and LCC packages, and  $\theta_{JA}$  is specified for device soldered in circuit board for the SOIC package.

### DICE CHARACTERISTICS

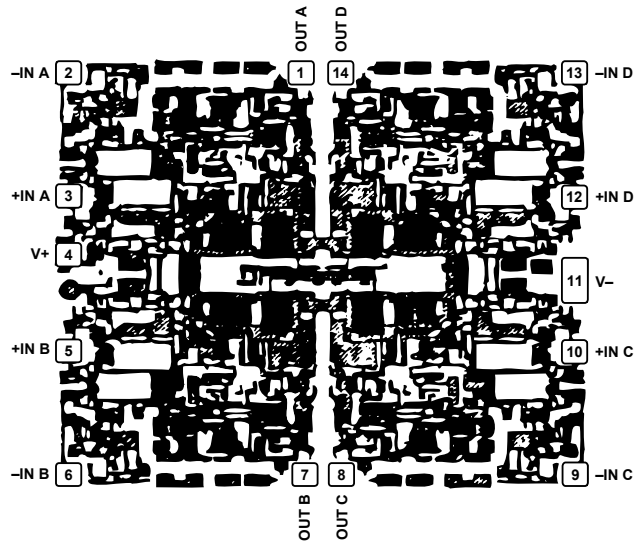

Figure 5. 0.111 Inch × 0.100 Inch DIE Size, 11,100 sq. mils, Substrate Connected to V+, 165 Transistors

### ESD CAUTION



**ESD (electrostatic discharge) sensitive device.** Charged devices and circuit boards can discharge without detection. Although this product features patented or proprietary protection circuitry, damage may occur on devices subjected to high energy ESD. Therefore, proper ESD precautions should be taken to avoid performance degradation or loss of functionality.

# TYPICAL PERFORMANCE CHARACTERISTICS

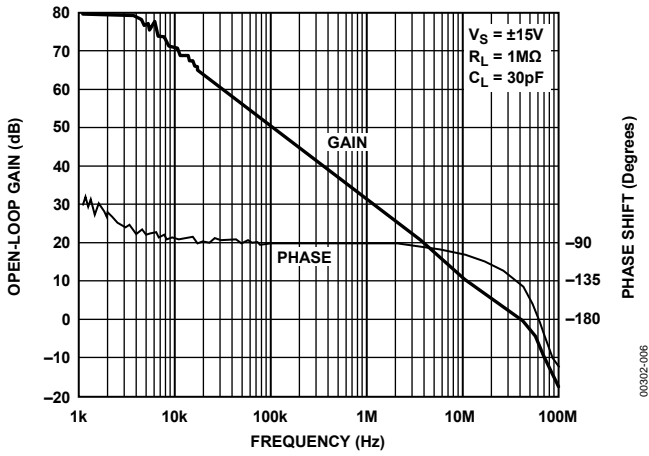

Figure 6. Open-Loop Gain, Phase vs. Frequency

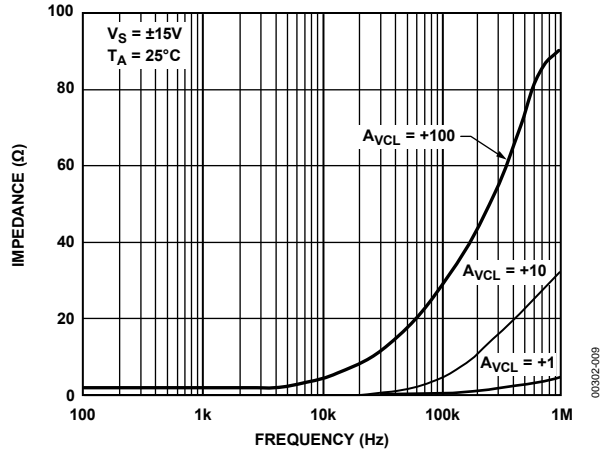

Figure 9. Closed-Loop Output Impedance vs. Frequency

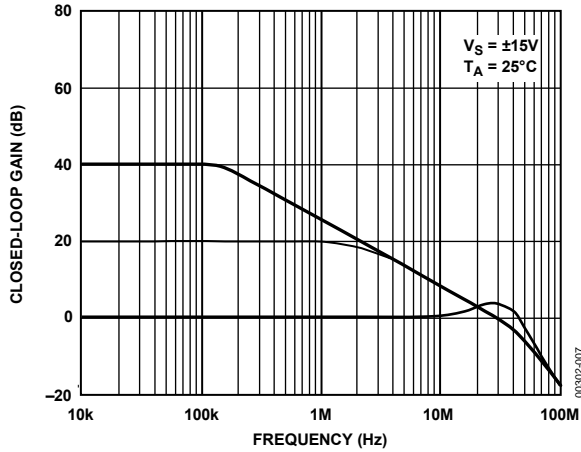

Figure 7. Closed-Loop Gain vs. Frequency

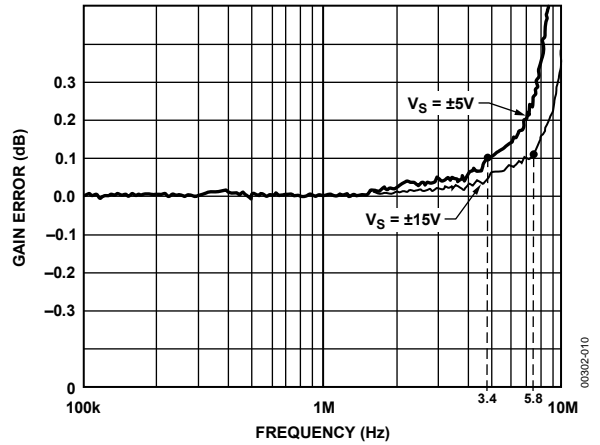

Figure 10. Gain Error vs. Frequency

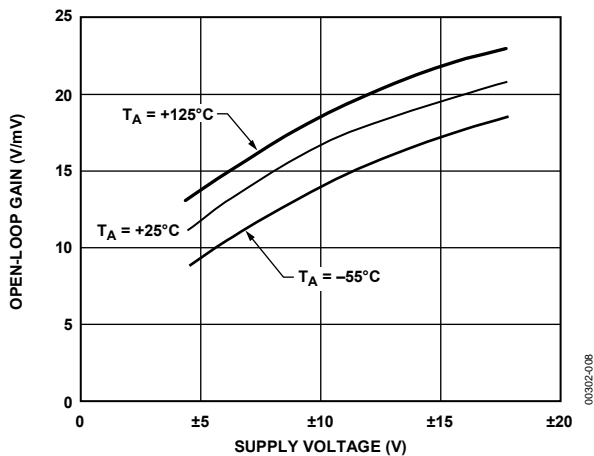

Figure 8. Open-Loop Gain vs. Supply Voltage

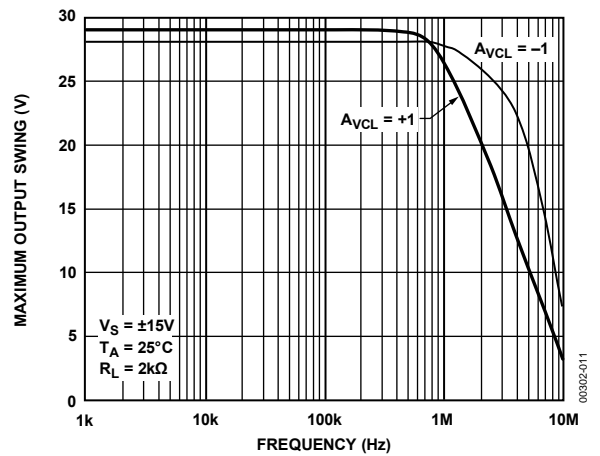

Figure 11. Maximum  $V_{OUT}$  Swing vs. Frequency

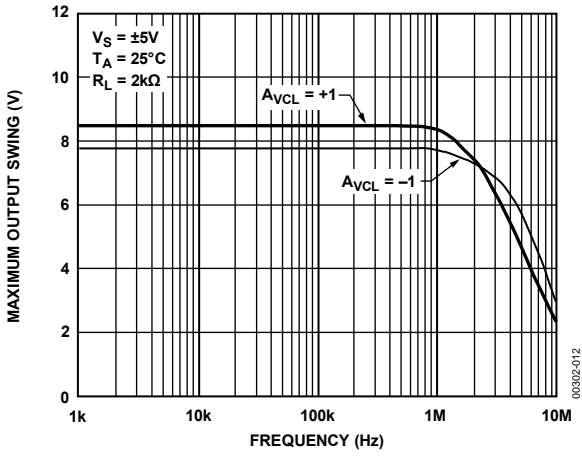

Figure 12. Maximum  $V_{OUT}$  Swing vs. Frequency

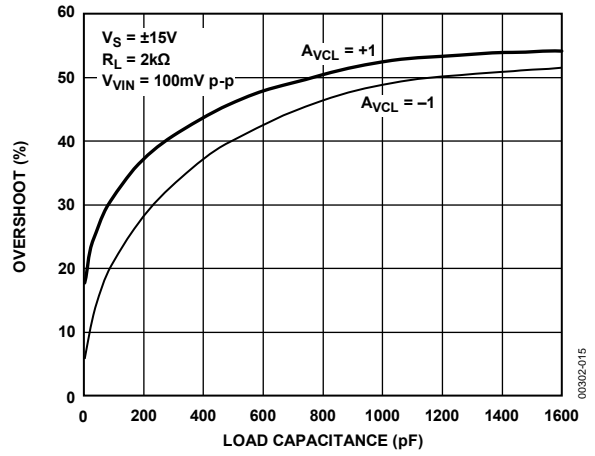

Figure 15. Small Signal Overshoot vs. Load Capacitance

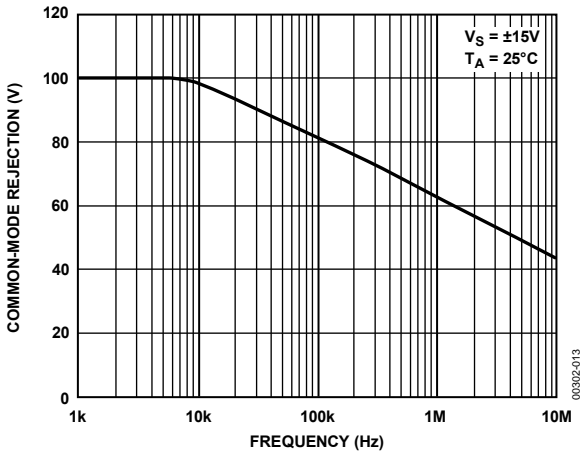

Figure 13. Common-Mode Rejection vs. Frequency

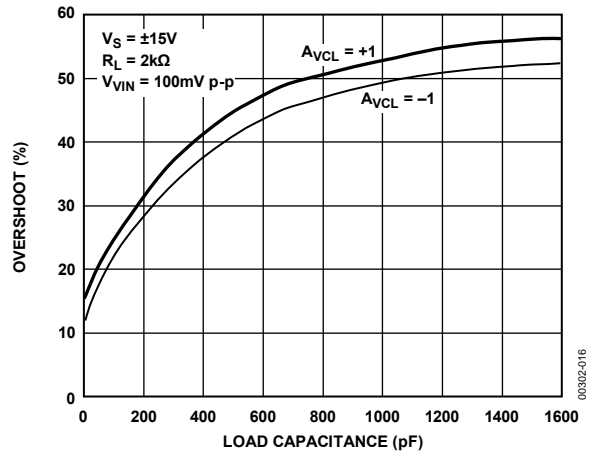

Figure 16. Small Signal Overshoot vs. Load Capacitance

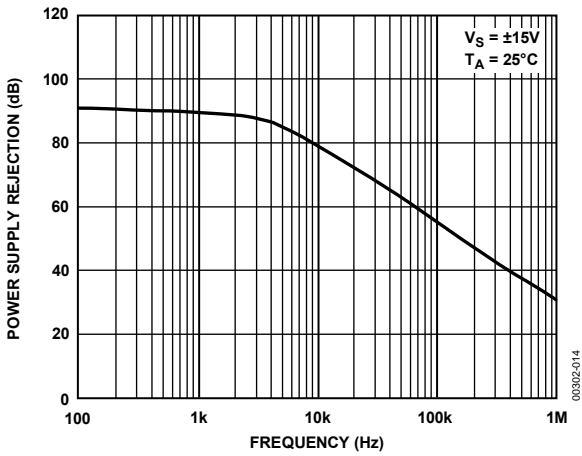

Figure 14. Power-Supply Rejection vs. Frequency

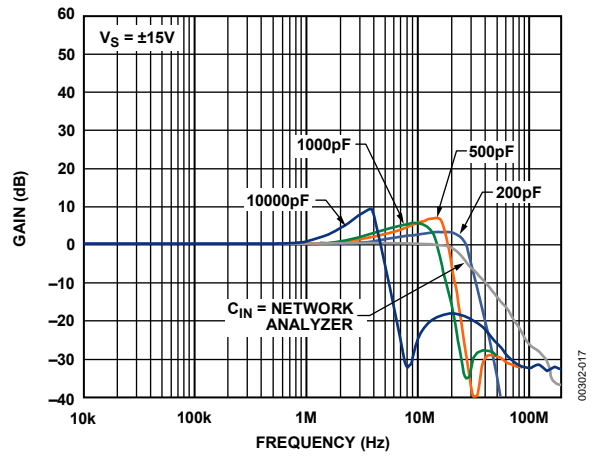

Figure 17. Noninverting Gain vs. Capacitive Loads

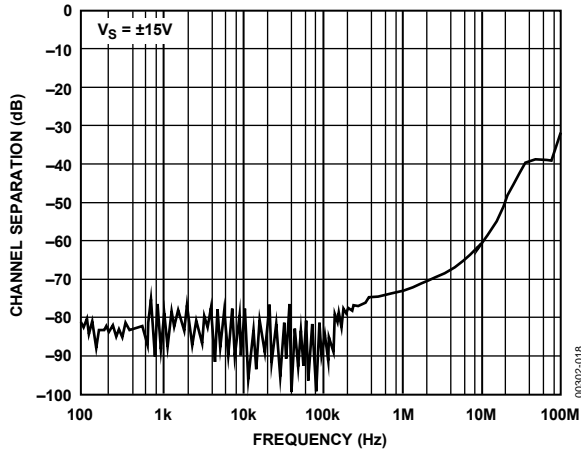

Figure 18. Channel Separation vs. Frequency

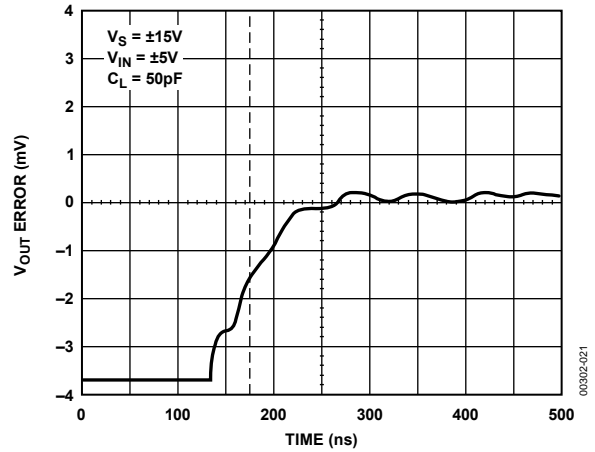

Figure 21. Settling Time, Negative Edge

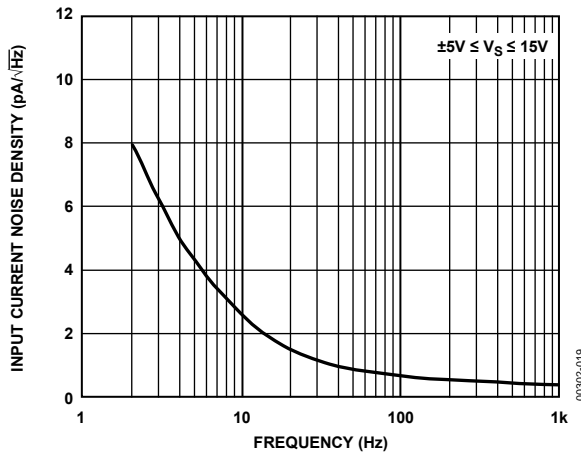

Figure 19. Input Current Noise Density vs. Frequency

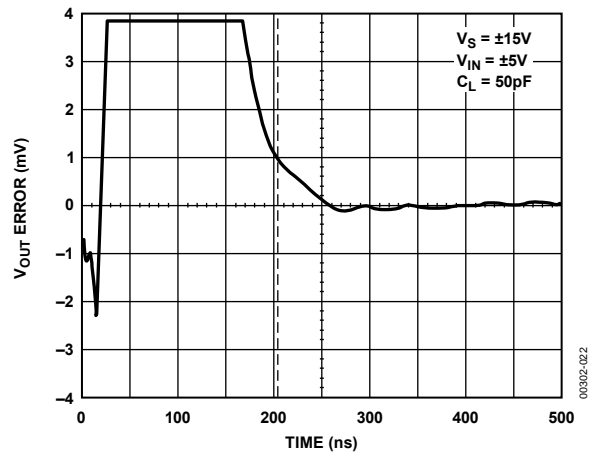

Figure 22. Settling Time, Positive Edge

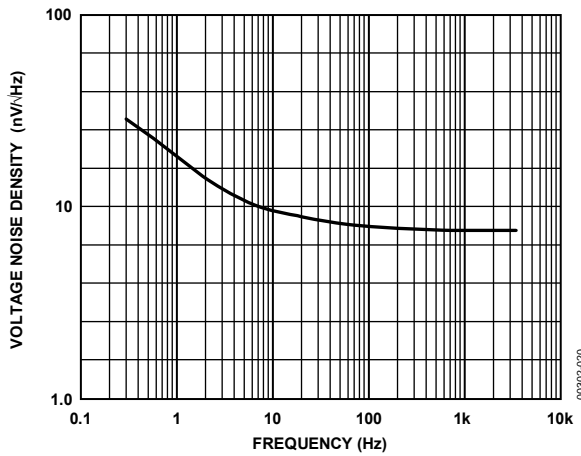

Figure 20. Voltage Noise Density vs. Frequency

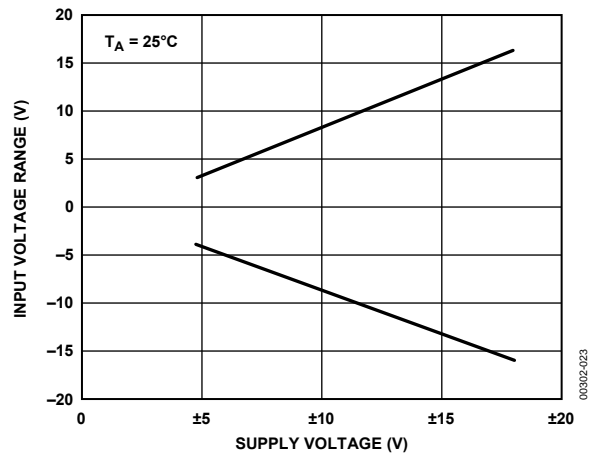

Figure 23. Input Voltage Range vs. Supply Voltage



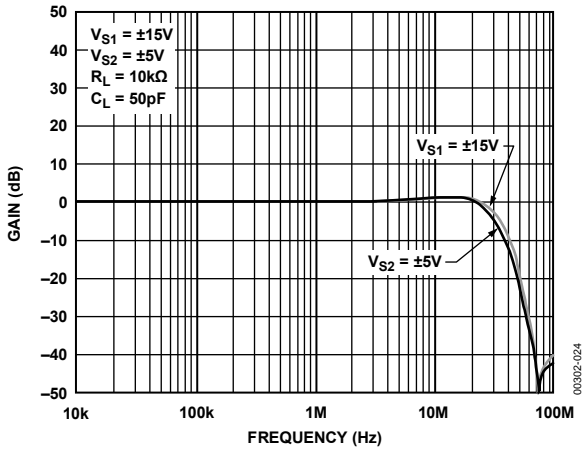

Figure 24. Noninverting Gain vs. Supply Voltage

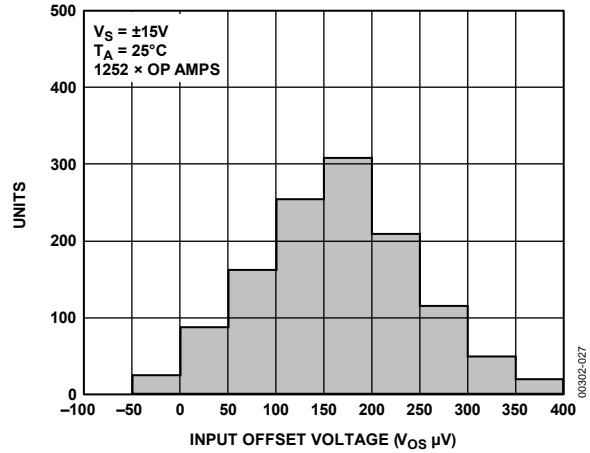

Figure 27. Input Offset Voltage Distribution

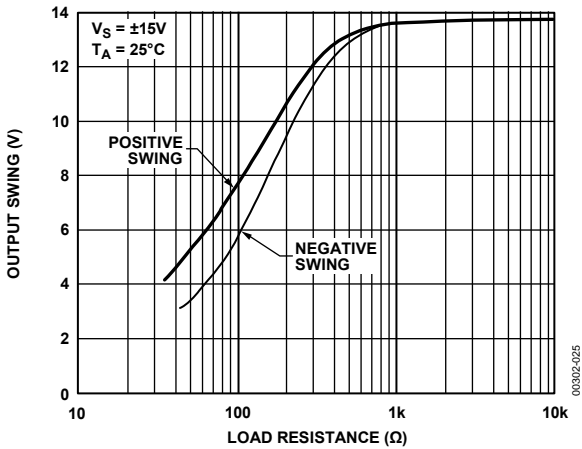

Figure 25. Output Swing vs. Load Resistance

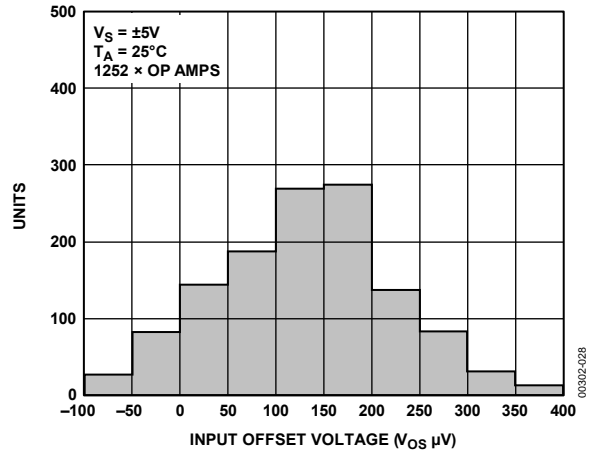

Figure 28. Input Offset Voltage Distribution

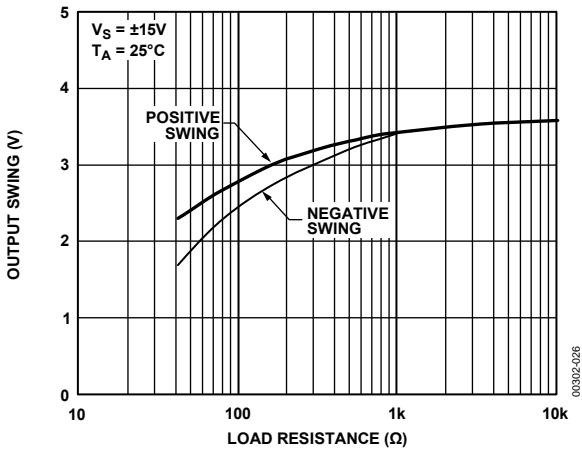

Figure 26. Output Swing vs. Load Resistance

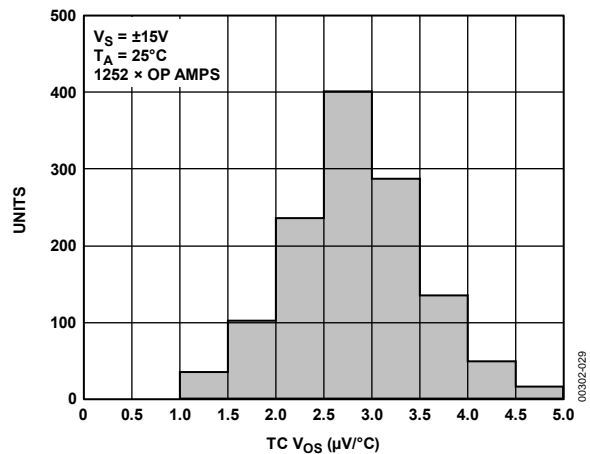

Figure 29. TC Vos Distribution

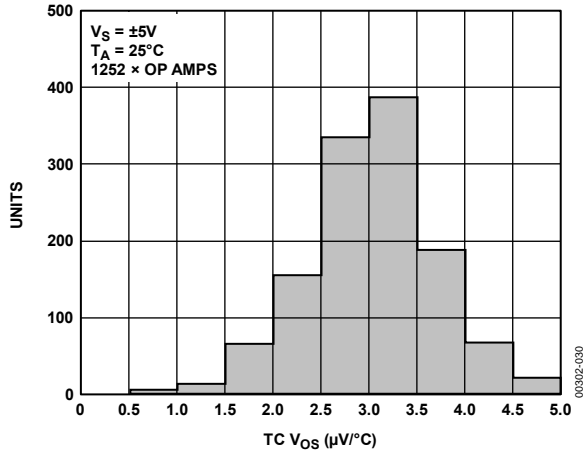

Figure 30. TC  $V_{OS}$  Distribution

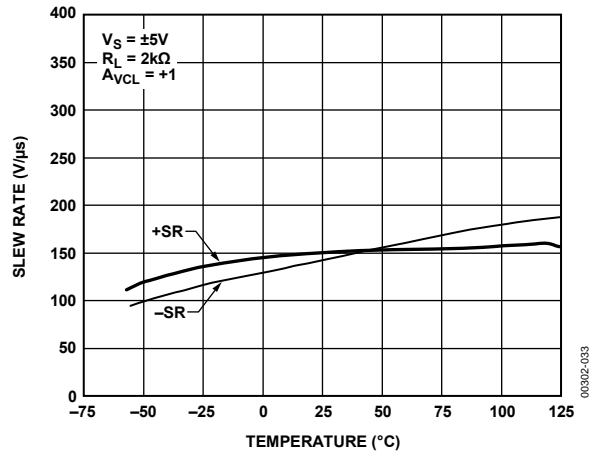

Figure 33. Slew Rate vs. Temperature

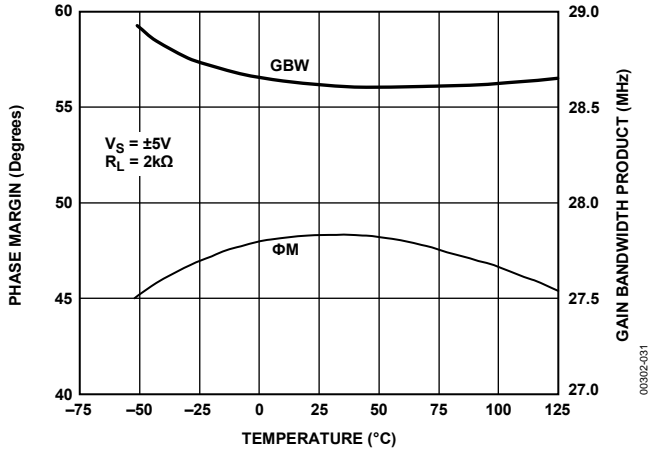

Figure 31. Phase Margin and Gain Bandwidth vs. Temperature

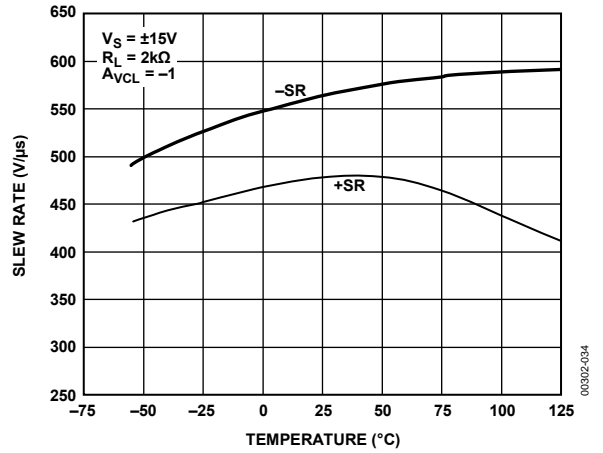

Figure 34. Slew Rate vs. Temperature

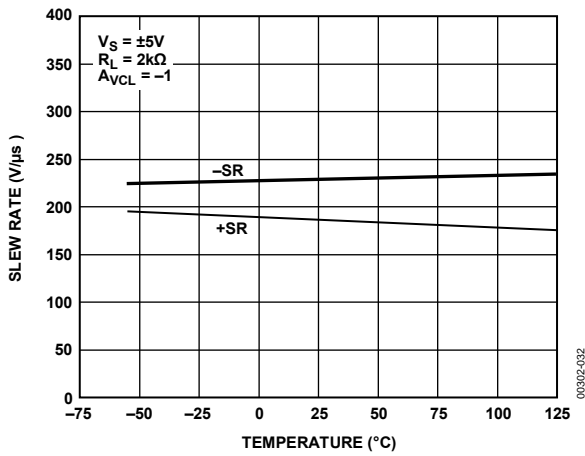

Figure 32. Slew Rate vs. Temperature

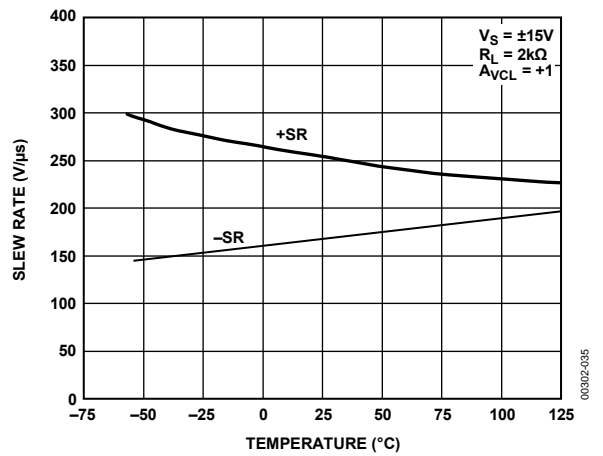

Figure 35. Slew Rate vs. Temperature

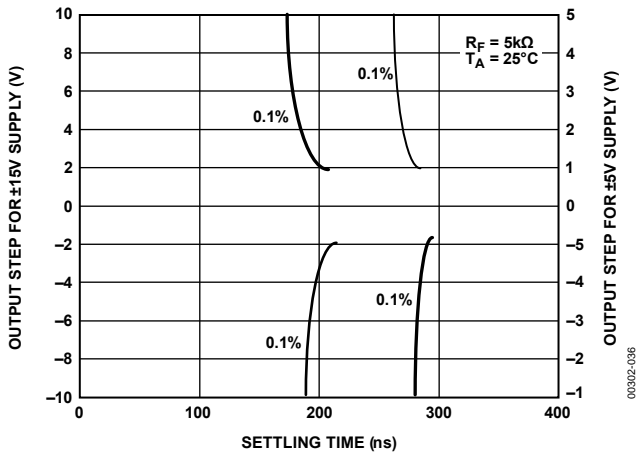

Figure 36. Output Step vs. Settling Time

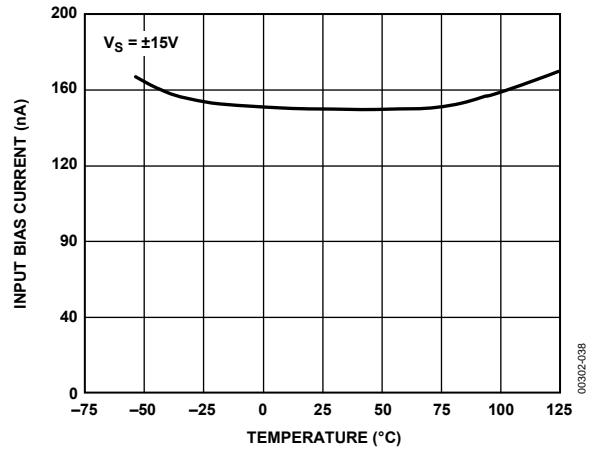

Figure 38. Input Bias Current vs. Temperature

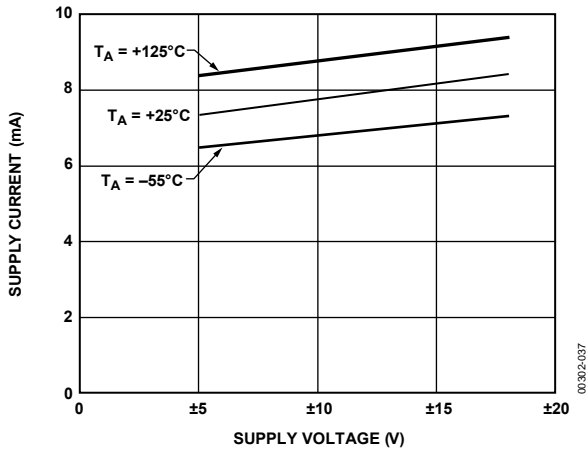

Figure 37. Supply Current vs. Supply Voltage

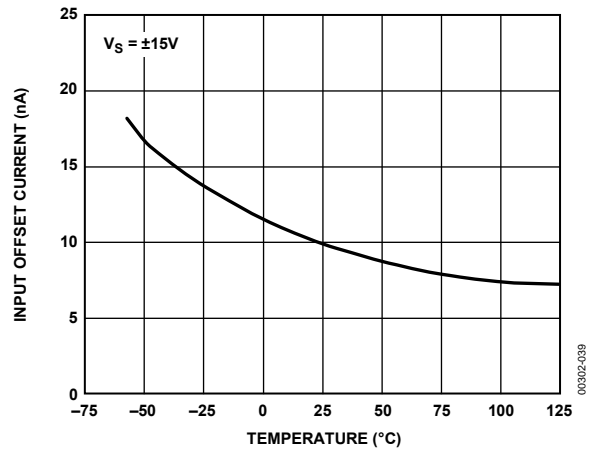

Figure 39. Input Offset Current vs. Temperature

## APPLICATIONS INFORMATION

### OUTPUT SHORT-CIRCUIT PERFORMANCE

To achieve a wide bandwidth and high slew rate, the OP467 output is not short-circuit protected. Shorting the output to ground or to the supplies may destroy the device.

For safe operation, the output load current should be limited so that the junction temperature does not exceed the absolute maximum junction temperature.

The maximum internal power dissipation can be calculated by

$$P_D = \frac{T_J \text{ max} - T_A}{\theta_{JA}}$$

where:

$T_J$  and  $T_A$  are junction and ambient temperatures, respectively.

$P_D$  is device internal power dissipation.

$\theta_{JA}$  is the packaged device thermal resistance given in the data sheet.

### UNUSED AMPLIFIERS

It is recommended that any unused amplifiers in the quad package be connected as a unity-gain follower with a 1 k $\Omega$  feedback resistor with noninverting input tied to the ground plain.

### PCB LAYOUT CONSIDERATIONS

Satisfactory performance of a high speed op amp largely depends on a good PCB layout. To achieve the best dynamic performance, follow the high frequency layout technique.

### GROUNDING

A good ground plain is essential to achieve the optimum performance in high speed applications. It can significantly reduce the undesirable effects of ground loops and IR drops by providing a low impedance reference point. Best results are obtained with a multilayer board design with one layer assigned to the ground plain. To maintain a continuous and low impedance ground, avoid running any traces on this layer.

### POWER SUPPLY CONSIDERATIONS

In high frequency circuits, device lead length introduces an inductance in series with the circuit. This inductance, combined with stray capacitance, forms a high frequency resonance circuit. Poles generated by these circuits cause gain peaking and additional phase shift, reducing the phase margin of the op amp and leading to an unstable operation.

A practical solution to this problem is to reduce the resonance frequency low enough to take advantage of the power supply rejection of the amplifier. This is easily done by placing capacitors across the supply line and the ground plane as close as possible to the device pin. Because capacitors also have internal parasitic components, such as stray inductance, selecting the right capacitor is important. To be effective, they should have low impedance over the frequency range of interest. Tantalum capacitors are an excellent choice for their high capacitance/size ratio, but their effective series resistance (ESR) increases with frequency making them less effective.

On the other hand, ceramic chip capacitors have excellent ESR and effective series inductance (ESL) performance at higher frequencies, and because of their small size, they can be placed very close to the device pin, further reducing the stray inductance. Best results are achieved by using a combination of these two capacitors. A 5  $\mu$ F to 10  $\mu$ F tantalum parallel capacitor with a 0.1  $\mu$ F ceramic chip capacitor is recommended. If additional isolation from high frequency resonances of the power supply is needed, a ferrite bead should be placed in series with the supply lines between the bypass capacitors and the power supply. Note that addition of the ferrite bead introduces a new pole and zero to the frequency response of the circuit and could cause unstable operation if it is not selected properly.

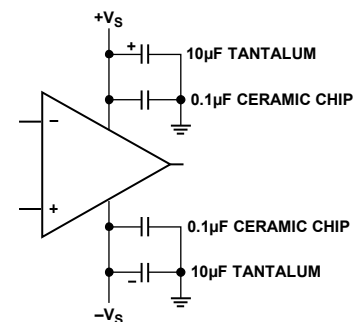

Figure 40. Recommended Power Supply Bypass

### SIGNAL CONSIDERATIONS

Input and output traces need special attention to assure a minimum stray capacitance. Input nodes are very sensitive to capacitive reactance, particularly when connected to a high impedance circuit. Stray capacitance can inject undesirable signals from a noisy line into a high impedance input. Protect high impedance input traces by providing guard traces around them, which also improves the channel separation significantly.

Additionally, any stray capacitance in parallel with the input capacitance of the op amp generates a pole in the frequency response of the circuit. The additional phase shift caused by this pole reduces the gain margin of the circuit. If this pole is within the gain range of the op amp, it causes unstable performance. To reduce these undesirable effects, use the lowest impedance where possible. Lowering the impedance at this node places the poles at a higher frequency, far above the gain range of the amplifier. Stray capacitance on the PCB can be reduced by making the traces narrow and as short as possible. Further reduction can be realized by choosing a smaller pad size, increasing the spacing between the traces, and using PCB material with a low dielectric constant insulator (dielectric constant of some common insulators: air = 1, Teflon® = 2.2, and FR4 = 4.7, with air being an ideal insulator).

Removing segments of the ground plane directly under the input and output pads is recommended.

# OP467

Outputs of high speed amplifiers are very sensitive to capacitive loads. A capacitive load introduces a pair of pole and zero to the frequency response of the circuit, reducing the phase margin, leading to unstable operation or oscillation.

Generally, it is good design practice to isolate the output of the amplifier from any capacitive load by placing a resistor between the output of the amplifier and the rest of the circuits. A series resistor of 10 Ω to 100 Ω is normally sufficient to isolate the output from a capacitive load.

The OP467 is internally compensated to provide stable operation and is capable of driving large capacitive loads without oscillation.

Sockets are not recommended because they increase the lead inductance/capacitance and reduce the power dissipation of the package by increasing the thermal resistance of the leads. If sockets must be used, use Teflon or pin sockets with the shortest possible leads.

## PHASE REVERSAL

The OP467 is immune to phase reversal; its inputs can exceed the supply rails by a diode drop without any phase reversal.

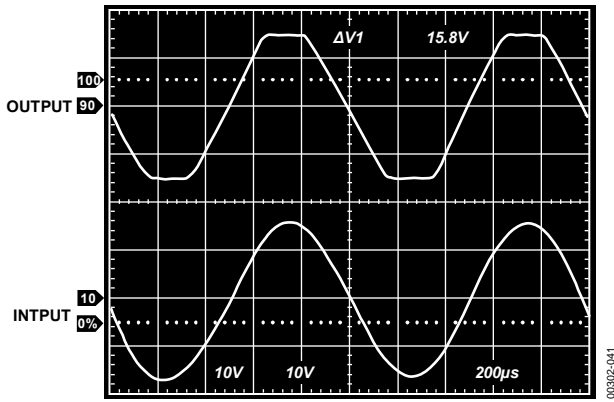

Figure 41. No Phase Reversal ( $A_v = +1$ )

## SATURATION RECOVERY TIME

The OP467 has a fast and symmetrical recovery time from either rail. This feature is very useful in applications such as high speed instrumentation and measurement circuits, where the amplifier is frequently exposed to large signals that overload the amplifier.

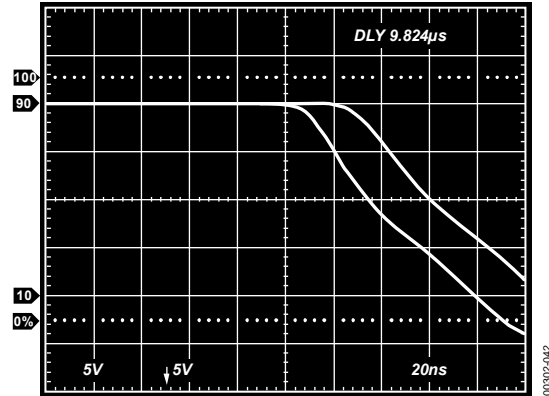

Figure 42. Saturation Recovery Time, Positive Rail

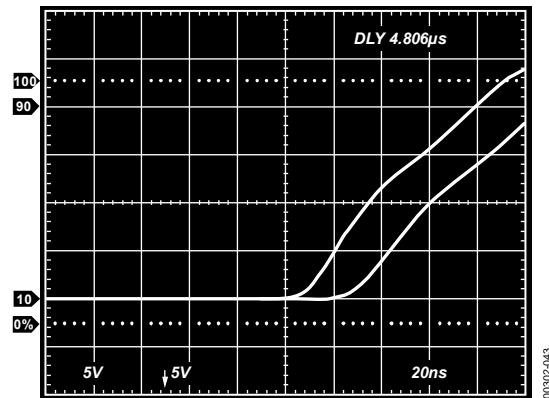

Figure 43. Saturation Recovery Time, Negative Rail

## HIGH SPEED INSTRUMENTATION AMPLIFIER

The OP467 performance lends itself to a variety of high speed applications, including high speed precision instrumentation amplifiers. Figure 44 represents a circuit commonly used for data acquisition, CCD imaging, and other high speed applications.

The circuit gain is set by  $R_G$ . A 2 kΩ resistor sets the circuit gain to 2; for unity gain, remove  $R_G$ . For any other gain settings, use the following formula

$$G = 2/R_G \text{ (Resistor Value is in k}\Omega\text{)}$$

$R_C$  is used for adjusting the dc common-mode rejection, and  $C_C$  is used for ac common-mode rejection adjustments.

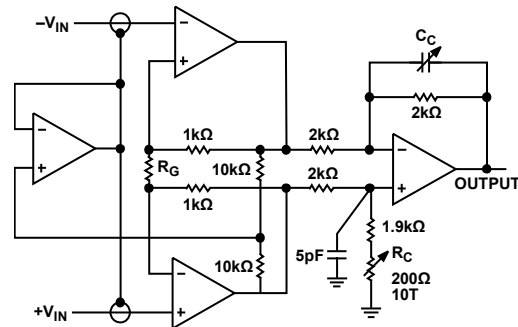

Figure 44. A High Speed Instrumentation Amplifier

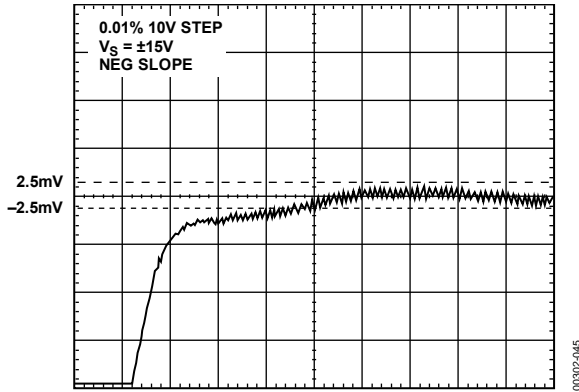

Figure 45. Instrumentation Amplifier Settling Time to 0.01% for a 10 V Step Input (Negative Slope)

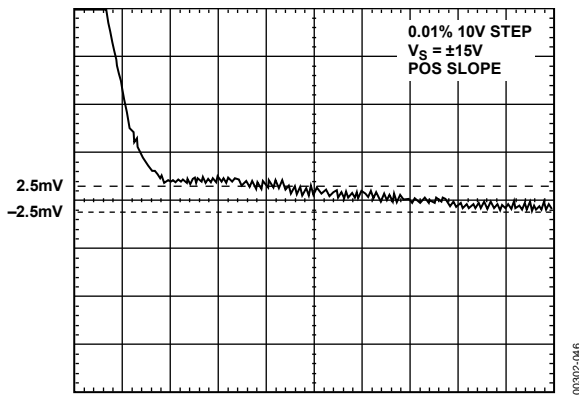

Figure 46. Instrumentation Amplifier Settling Time to 0.01% for a 10 V Step Input (Positive Slope)

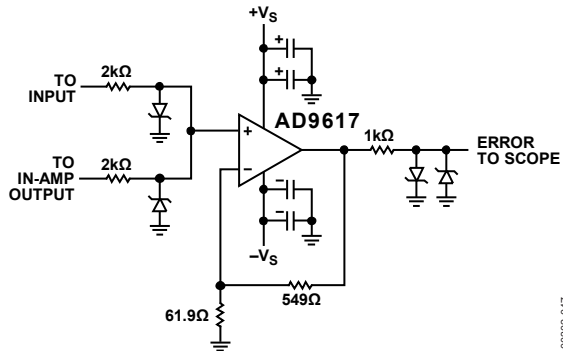

Figure 47. Settling Time Measurement Circuit

## 2 MHz BIQUAD BAND-PASS FILTER

The circuit in Figure 48 is commonly used in medical imaging ultrasound receivers. The 30 MHz bandwidth is sufficient to accurately produce the 2 MHz center frequency, as the measured response shows in Figure 49. When the bandwidth of the op amp is too close to the center frequency of the filter, the internal phase shift of the amplifier causes excess phase shift at 2 MHz, which alters the response of the filter. In fact, if the chosen op amp has a bandwidth close to 2 MHz, the combined phase shift of the three op amps causes the loop to oscillate.

Careful consideration must be given to the layout of this circuit as with any other high speed circuit.

If the phase shift introduced by the layout is large enough, it can alter the circuit performance, or worse, cause oscillation.

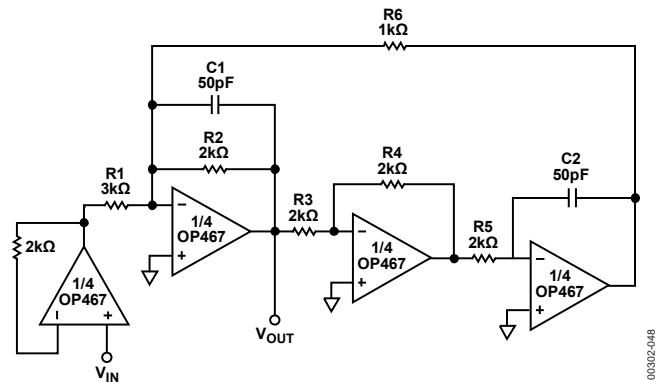

Figure 48. 2 MHz Biquad Filter

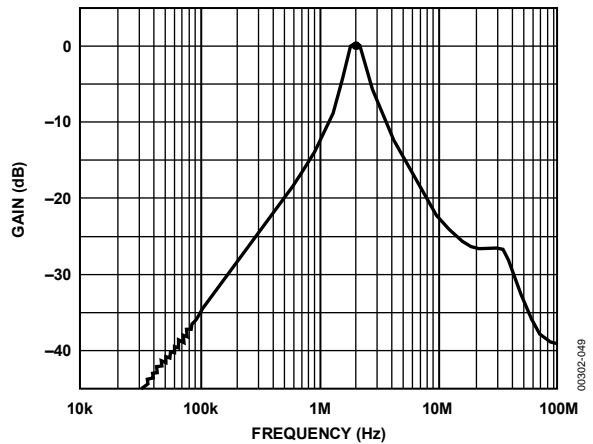

Figure 49. Biquad Filter Response

# OP467

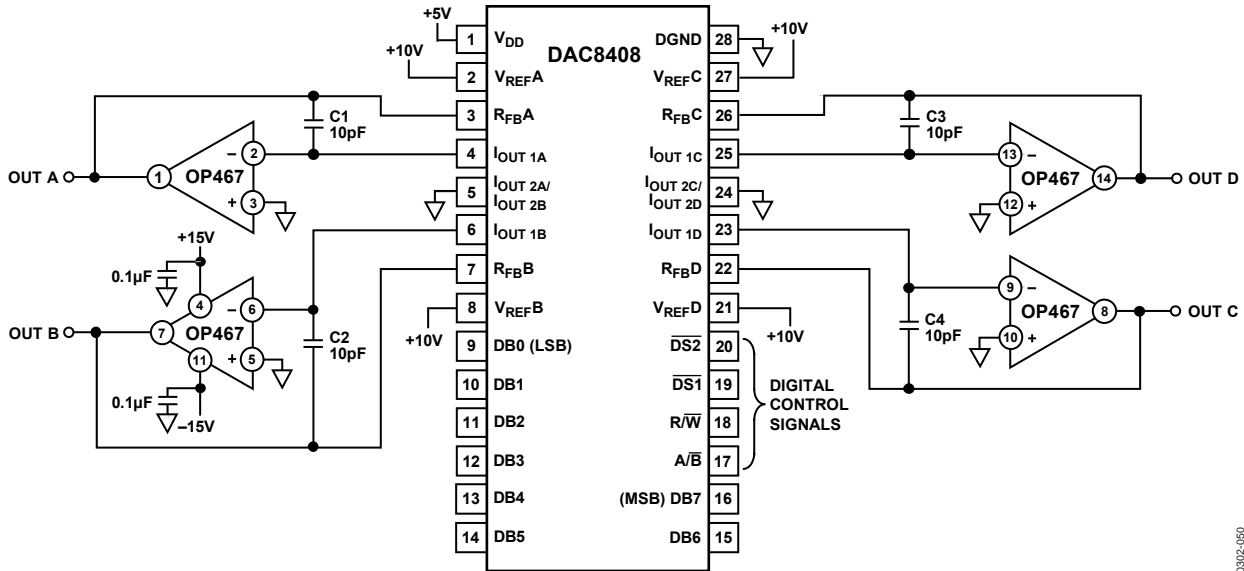

Figure 50. Quad DAC Unipolar Operation

## FAST I-TO-V CONVERTER

The fast slew rate and fast settling time of the OP467 are well suited to the fast buffers and I-to-V converters used in a variety of applications. The circuit in Figure 50 is a unipolar quad DAC consisting of only two ICs. The current output of the DAC8408 is converted to a voltage by the OP467 configured as an I-to-V converter. This circuit is capable of settling to 0.1% within 200 ns. Figure 51 and Figure 52 show the full-scale settling time of the outputs. To obtain reliable circuit performance, keep the traces from the  $I_{OUT}$  of the DAC to the inverting inputs of the OP467 short to minimize parasitic capacitance.

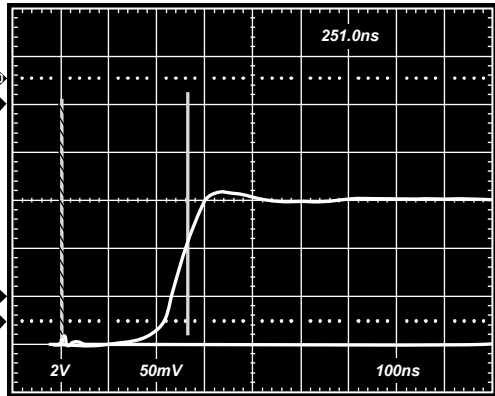

Figure 52. Rising Edge Output Settling Time

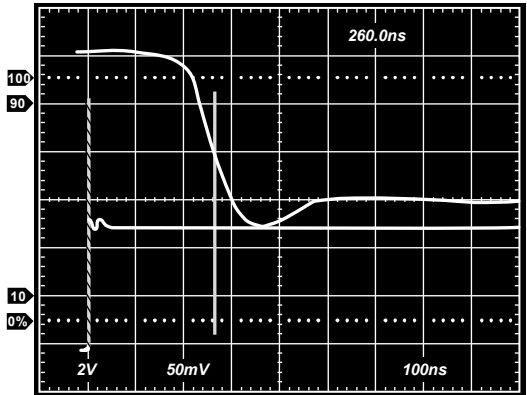

Figure 51. Falling Edge Output Settling Time

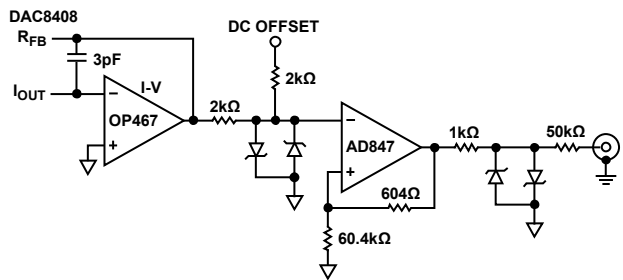
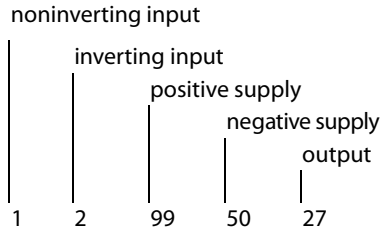

Figure 53. DAC  $V_{out}$  Settling Time Circuit

**OP467 SPICE MARCO-MODEL**

\* Node assignments



\*  
.SUBCKT OP467

\*  
\* INPUT STAGE

```

I1      4  5  10E-3
        0
CIN     1  2  1E-12
IOS     1  2  5E-9
Q1      5  2  8 QN
Q2      6  7  9 QN
R3      99 5  185.681
R4      99 6  185.681
R5      8  4  180.508
R6      9  4  180.508
EOS     7  1  POLY (1)      (14,20)  50E-6  1
EREF   98  0  (20,0) 1
    
```

\* GAIN STAGE AND DOMINANT POLE AT 1.5 kHz

```

R7      10 98  3.714E6
C2      10 98  28.571E-12
G1      98 10  (5,6) 5.386E-3
V1      99 11  1.6
V2      12 50  1.6
D1      10 11  DX
D2      12 10  DX
RC      10 28  1.4E3
CC      28 27  12E-12
    
```

\*  
\* COMMON-MODE STAGE WITH ZERO AT 1.26 kHz

```

ECM     13 98  POLY (2)  (1, 20)  (2,20) 0 0. 5 0. 5
R8      13 14  1E6
R9      14 98  25.119
C3      13 14  126.721E-12
    
```

\*POLE AT 400E6

```

R10     15 98  1E6
C4      15 98  0.398E-15
G2      98 15  (10,20) 1E-6
    
```

\* OUTPUT STAGE

```

ISY     99 50  -8.183E-3
RMP1    99 20  96.429E3
RMP2    20 50  96.429E3
RO1     99 26  200
RO2     26 50  200
L1      26 27  1E-7
GO1     26 99  (99,15) 5E-3
GO2     50 26  (15,50) 5E-3
G4      23 50  (15,26) 5E-3
G5      24 50  (26,15) 5E-3
V3      21 26  50
V4      26 22  50
D3      15 21  DX
D4      22 15  DX
D5      99 23  DX
D6      99 24  DX
D7      50 23  DY
D8      50 24  DY
    
```

\* MODELS USED

```

*
.MODEL QN NPN (BF=33.333E3)
.MODEL DX D
.MODEL DY D (BV=50)
.ENDS OP467
    
```



# OP467

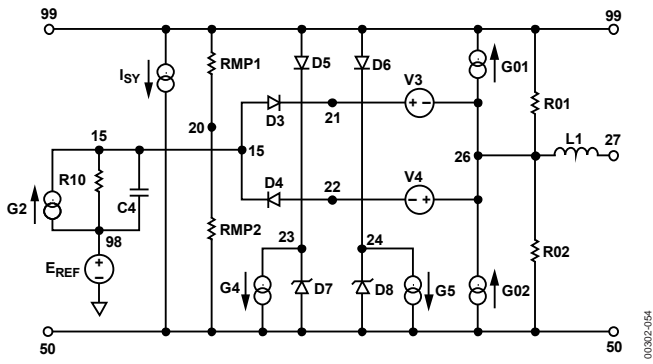

Figure 54. SPICE Macro-Model Output Stage

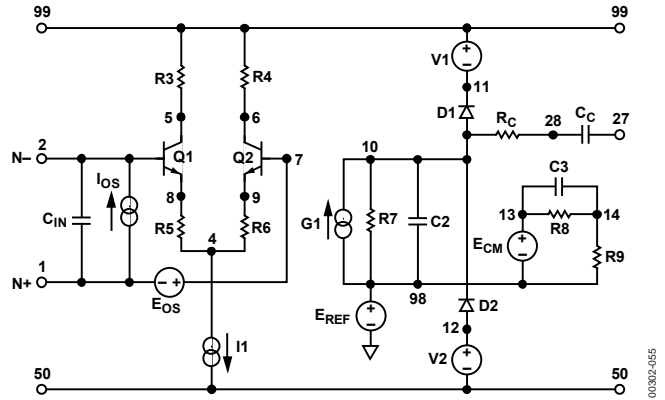
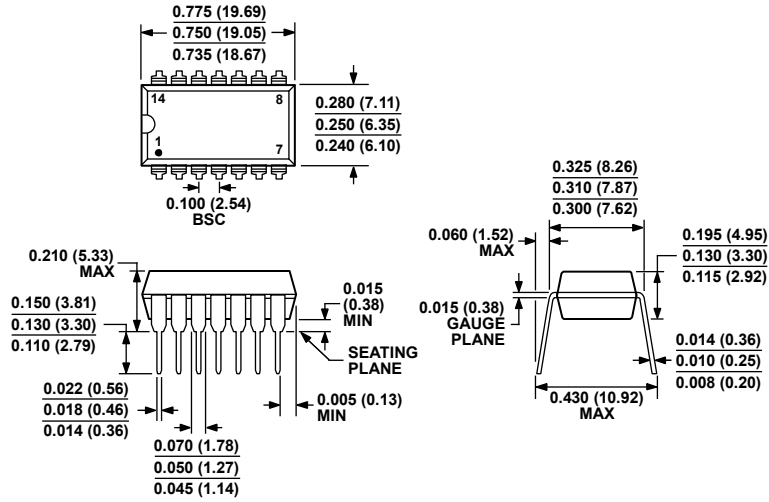

Figure 55. SPICE Macro-Model Input and Gain Stage

OUTLINE DIMENSIONS



COMPLIANT TO JEDEC STANDARDS MS-001  
 CONTROLLING DIMENSIONS ARE IN INCHES; MILLIMETER DIMENSIONS  
 (IN PARENTHESES) ARE ROUNDED-OFF INCH EQUIVALENTS FOR  
 REFERENCE ONLY AND ARE NOT APPROPRIATE FOR USE IN DESIGN.  
 CORNER LEADS MAY BE CONFIGURED AS WHOLE OR HALF LEADS.

Figure 56. 14-Lead Plastic Dual In-Line Package [PDIP]  
 (N-14)  
 P-Suffix  
 Dimensions shown in inches and (millimeters)

070606-A

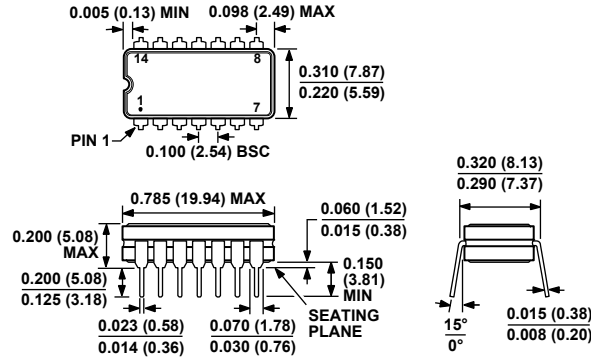

CONTROLLING DIMENSIONS ARE IN INCHES; MILLIMETER DIMENSIONS  
 (IN PARENTHESES) ARE ROUNDED-OFF INCH EQUIVALENTS FOR  
 REFERENCE ONLY AND ARE NOT APPROPRIATE FOR USE IN DESIGN.

Figure 57. 14-Lead Ceramic Dual In-Line Package [CERDIP]  
 (Q-14)  
 Y-Suffix  
 Dimensions shown in inches and (millimeters)

# OP467

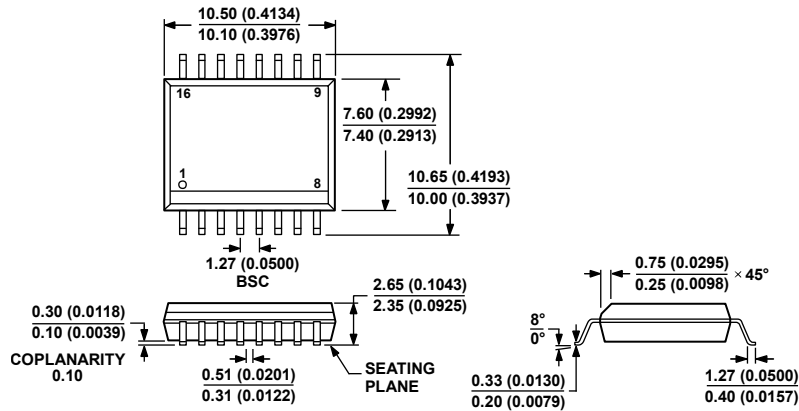

COMPLIANT TO JEDEC STANDARDS MS-013-AA  
CONTROLLING DIMENSIONS ARE IN MILLIMETERS; INCH DIMENSIONS  
(IN PARENTHESES) ARE ROUNDED-OFF MILLIMETER EQUIVALENTS FOR  
REFERENCE ONLY AND ARE NOT APPROPRIATE FOR USE IN DESIGN.

Figure 58. 16-Lead Standard Small Outline Package [SOIC\_W]  
Wide Body (RW-16)  
S-Suffix

Dimensions shown in millimeters and (inches)

032707-B

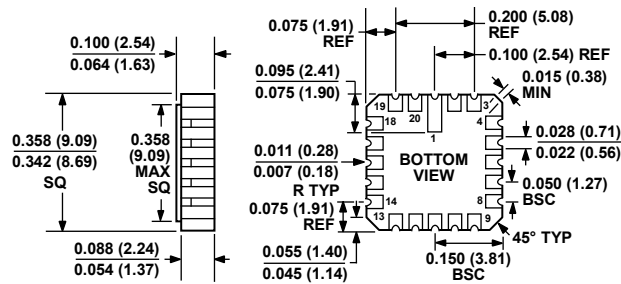

CONTROLLING DIMENSIONS ARE IN INCHES; MILLIMETER DIMENSIONS  
(IN PARENTHESES) ARE ROUNDED-OFF INCH EQUIVALENTS FOR  
REFERENCE ONLY AND ARE NOT APPROPRIATE FOR USE IN DESIGN.

Figure 59. 20-Terminal Ceramic Leadless Chip Carrier [LCC]  
(E-20-1) RC-Suffix

Dimensions shown in inches and (millimeters)

022106-A

## ORDERING GUIDE

Model <sup>1</sup>	Temperature Range	Package Description	Package Option
OP467GP	-40°C to +85°C	14-Lead PDIP	N-14
OP467GPZ	-40°C to +85°C	14-Lead PDIP	N-14
OP467GS	-40°C to +85°C	16-Lead SOIC_W	RW-16
OP467GS-REEL	-40°C to +85°C	16-Lead SOIC_W	RW-16
OP467GSZ	-40°C to +85°C	16-Lead SOIC_W	RW-16
OP467GSZ-REEL	-40°C to +85°C	16-Lead SOIC_W	RW-16
OP467ARC/883C	-55°C to +125°C	20-Terminal LCC	E-20-1
OP467AY/883C	-55°C to +125°C	14-Lead CERDIP	Q-14
OP467GBC		Die	

<sup>1</sup> Z = RoHS Compliant Part.

# Mouser Electronics

Authorized Distributor

Click to View Pricing, Inventory, Delivery & Lifecycle Information:

[Analog Devices Inc.:](#)

[5962-9325801M2A](#) [OP467AY/883C](#) [OP467GS](#) [OP467GP](#) [OP467GPZ](#) [OP467GSZ](#) [5962-9325801MCA](#)  
[OP467ARC/883C](#) [OP467GS-REEL](#) [OP467GSZ-REEL](#)