

CMLSH05-4DO
SURFACE MOUNT SILICON
DUAL, ISOLATED OPPOSING
LOW V_F SCHOTTKY DIODE

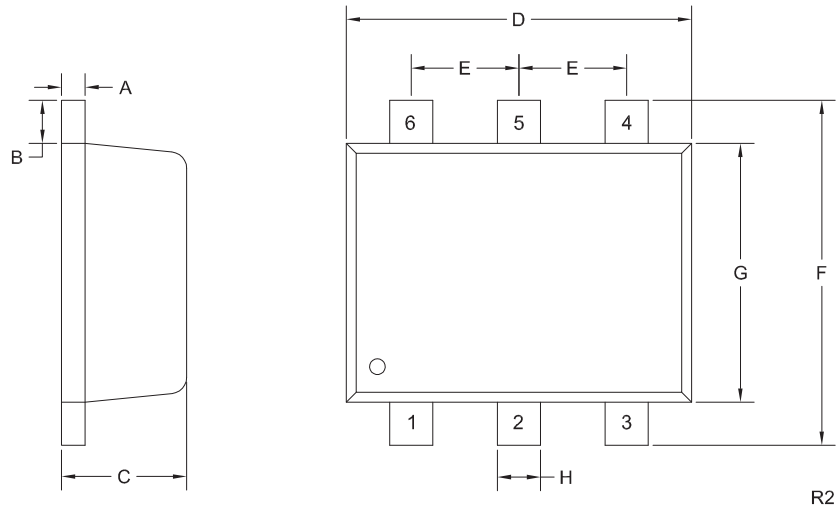

SOT-563 CASE - MECHANICAL OUTLINE



PIN CONFIGURATION

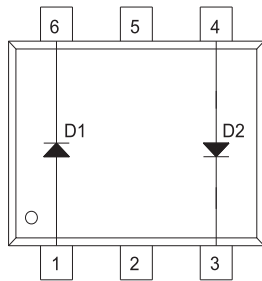

| SYMBOL | INCHES | | MILLIMETERS | |
|--------|--------|-------|-------------|------|
| | MIN | MAX | MIN | MAX |
| A | 0.0027 | 0.007 | 0.07 | 0.18 |
| B | 0.008 | | 0.20 | |
| C | 0.017 | 0.024 | 0.45 | 0.60 |
| D | 0.059 | 0.067 | 1.50 | 1.70 |
| E | 0.020 | | 0.50 | |
| F | 0.059 | 0.067 | 1.50 | 1.70 |
| G | 0.043 | 0.051 | 1.10 | 1.30 |
| H | 0.006 | 0.012 | 0.15 | 0.30 |

SOT-563 (REV: R2)

LEAD CODE:

- 1) Anode D1
- 2) NC
- 3) Cathode D2
- 4) Anode D2
- 5) NC
- 6) Cathode D1

MARKING CODE: CO4

R6 (8-January 2018)

CMLSH05-4DO

SURFACE MOUNT SILICON
DUAL, ISOLATED OPPOSING
LOW V_F SCHOTTKY DIODE



TYPICAL ELECTRICAL CHARACTERISTICS

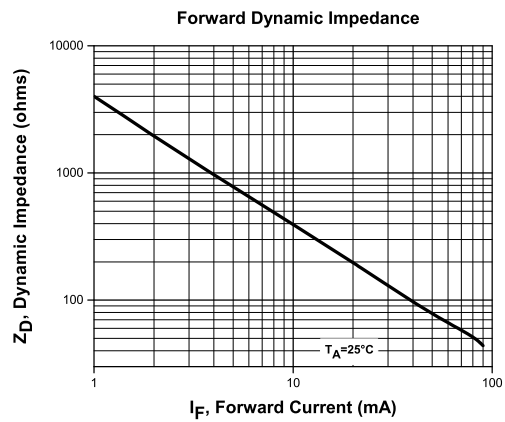
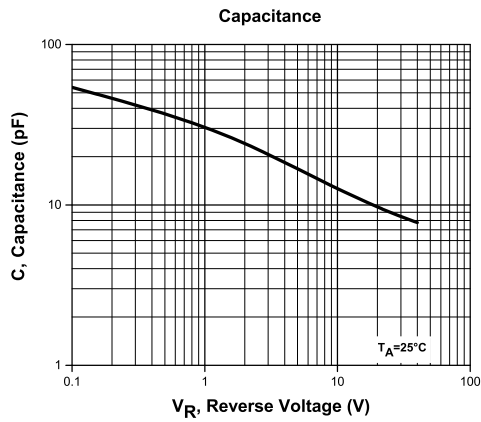
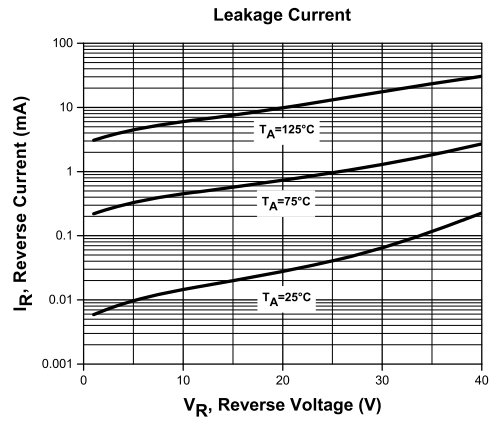
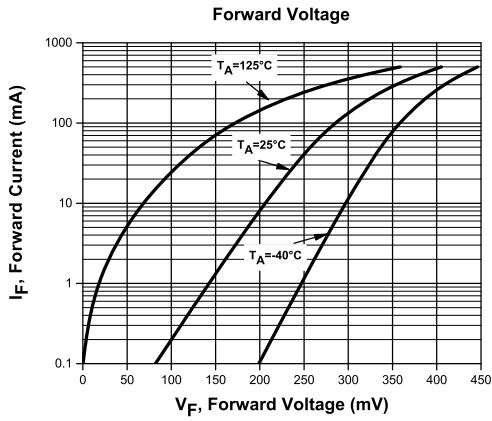

R6 (8-January 2018)

CMLSH05-4DO

SURFACE MOUNT SILICON
DUAL, ISOLATED OPPOSING
LOW V_F SCHOTTKY DIODE



TYPICAL ELECTRICAL CHARACTERISTICS

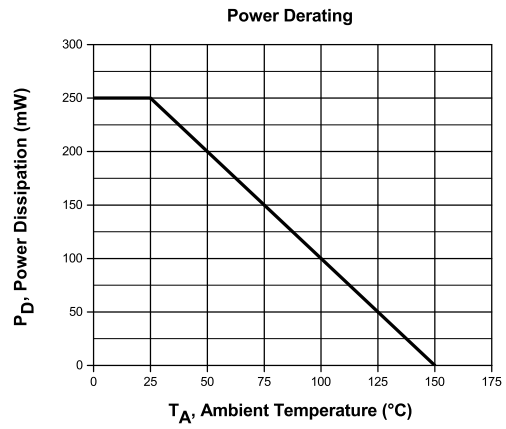
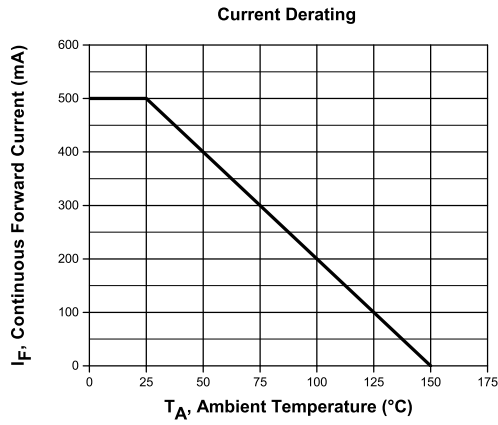

R6 (8-January 2018)

OUTSTANDING SUPPORT AND SUPERIOR SERVICES



PRODUCT SUPPORT

Central's operations team provides the highest level of support to insure product is delivered on-time.

- Supply management (Customer portals)
- Inventory bonding
- Consolidated shipping options
- Custom bar coding for shipments
- Custom product packing

DESIGNER SUPPORT/SERVICES

Central's applications engineering team is ready to discuss your design challenges. Just ask.

- Free quick ship samples (2nd day air)
- Online technical data and parametric search
- SPICE models
- Custom electrical curves
- Environmental regulation compliance
- Customer specific screening
- Up-screening capabilities
- Special wafer diffusions
- PbSn plating options
- Package details
- Application notes
- Application and design sample kits
- Custom product and package development

REQUESTING PRODUCT PLATING

1. If requesting Tin/Lead plated devices, add the suffix " TIN/LEAD" to the part number when ordering (example: 2N2222A TIN/LEAD).
2. If requesting Lead (Pb) Free plated devices, add the suffix " PBFREE" to the part number when ordering (example: 2N2222A PBFREE).

CONTACT US

Corporate Headquarters & Customer Support Team

Central Semiconductor Corp.
145 Adams Avenue
Hauppauge, NY 11788 USA
Main Tel: (631) 435-1110
Main Fax: (631) 435-1824
Support Team Fax: (631) 435-3388
www.centrasemi.com

Worldwide Field Representatives:
www.centrasemi.com/wwreps

Worldwide Distributors:
www.centrasemi.com/wwdistributors

For the latest version of Central Semiconductor's **LIMITATIONS AND DAMAGES DISCLAIMER**, which is part of Central's Standard Terms and Conditions of sale, visit: www.centrasemi.com/terms