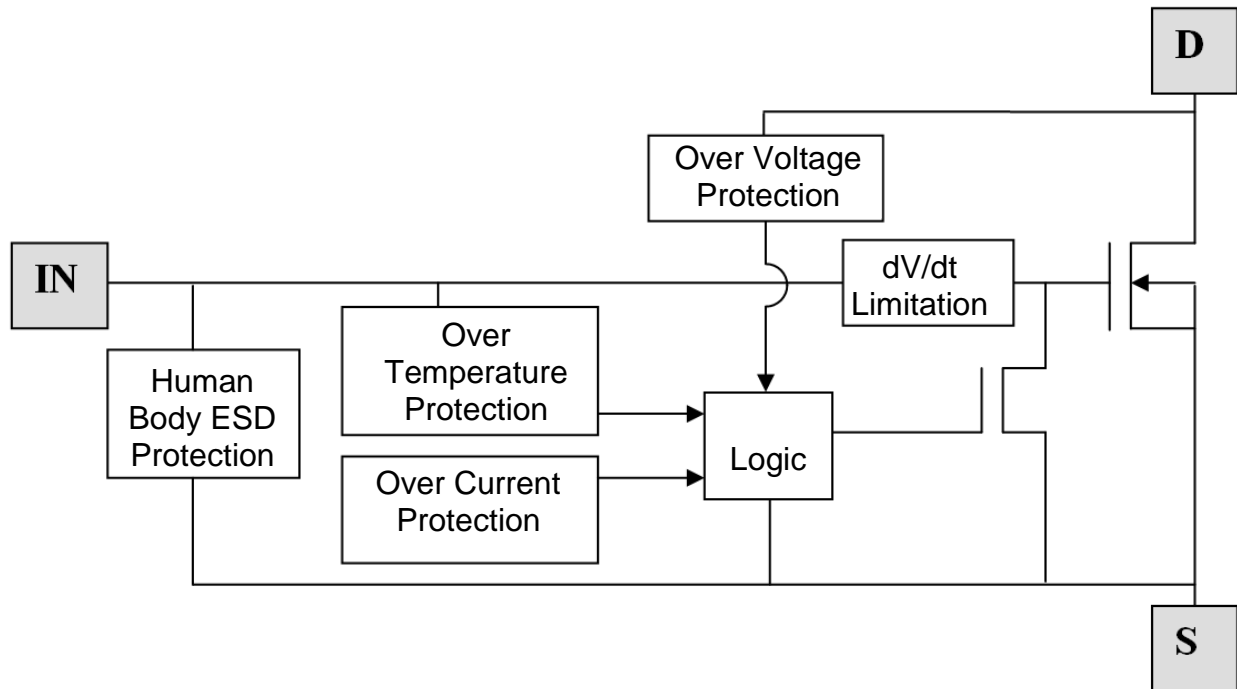

Functional Block Diagram

Absolute Maximum Ratings (@T_A = +25°C, unless otherwise stated.)

Characteristic	Symbol	Value	Unit
Continuous Drain-Source Voltage	V _{DS}	60	V
Drain-Source Voltage for Short Circuit Protection	V _{DS(SC)}	36	V
Continuous Input Voltage	V _{IN}	-0.5 to +6	V
Continuous Input Current @ -0.2V ≤ V _{IN} ≤ 6V	I _{IN}	No Limit	mA
Continuous Input Current @ V _{IN} < -0.2V or V _{IN} > 6V	I _{IN}	I _{IN} ≤ 2	mA
Pulsed Drain Current @ V _{IN} = 3.3V	I _{DM}	2	A
Pulsed Drain Current @ V _{IN} = 5V	I _{DM}	2.5	A
Continuous Source Current (Body Diode) (Note 5)	I _S	1	A
Pulsed Source Current (Body Diode)	I _{SM}	5	A
Unclamped Single Pulse Inductive Energy, T _J = +25°C, I _D = 0.5A, V _{DD} = 24V	E _{AS}	490	mJ
Electrostatic Discharge (Human Body Model)	V _{ESD}	4000	V
Charged Device Model	V _{CDM}	1000	V

Thermal Resistance

Characteristic	Symbol	Value	Unit
Power Dissipation at T _A = +25°C (Note 5)	P _D	1.3	W
Linear Derating Factor	P _D	10.4	mW/°C
Power Dissipation at T _A = +25°C (Note 6)	P _D	3.0	W
Linear Derating Factor	P _D	24	mW/°C
Thermal Resistance, Junction to Ambient (Note 5)	R _{θJA}	96	°C/W
Thermal Resistance, Junction to Ambient (Note 6)	R _{θJA}	42	°C/W
Thermal Resistance, Junction to Case (Note 7)	R _{θJC}	12	°C/W
Operating Temperature Range	T _J	-40 to +150	°C
Storage Temperature Range	T _{STG}	-55 to +150	°C

Notes: 5. For a device surface mounted on 15mm x 15mm single sided 1oz weight copper on 1.6mm FR-4 board, in still air conditions.
6. For a device surface mounted on 50mm x 50mm single sided 2oz weight copper on 1.6mm FR-4 board, in still air conditions.
7. Thermal resistance between junction and the mounting surfaces of drain and source pins.

Recommended Operating Conditions

The ZXMS6004DG is optimized for use with μC operating from 3.3V and 5V supplies.

Characteristic	Symbol	Min	Max	Unit
Input Voltage Range	V_{IN}	0	5.5	V
Ambient Temperature Range	T_A	-40	+125	$^{\circ}\text{C}$
High Level Input Voltage for MOSFET to be on	V_{IH}	3	5.5	V
Low Level Input Voltage for MOSFET to be off	V_{IL}	0	0.7	V
Peripheral Supply Voltage (Voltage to Which Load is Referred)	V_P	0	36	V

Thermal Characteristics

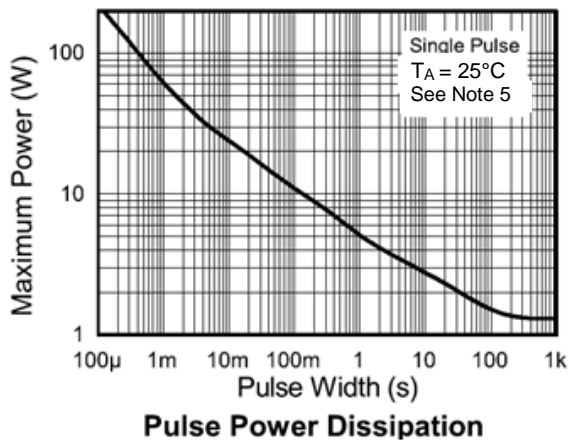
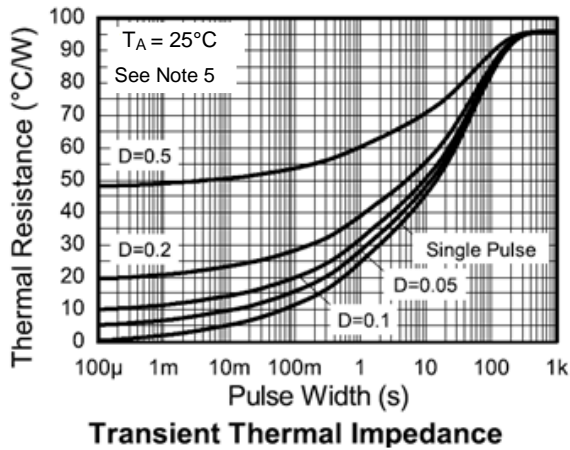
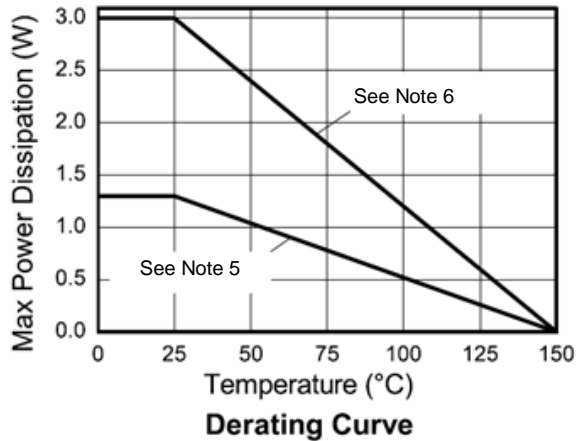
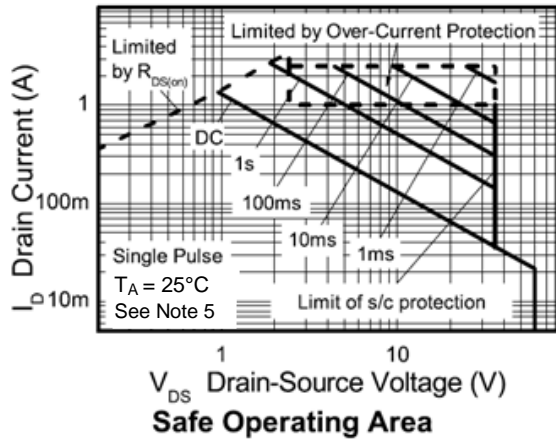

Electrical Characteristics (@T_A = +25°C, unless otherwise stated.)

Characteristic	Symbol	Min	Typ	Max	Unit	Test Condition
Static Characteristics						
Drain-Source Clamp Voltage	V _{DS(AZ)}	60	65	70	V	I _D = 10mA
Off State Drain Current	I _{DSS}	–	–	0.5	μA	V _{DS} = 12V, V _{IN} = 0V
		–	–	1		V _{DS} = 36V, V _{IN} = 0V
Input Threshold Voltage	V _{IN(TH)}	0.7	1.2	1.5	V	V _{DS} = V _{GS} , I _D = 1mA
Input Current	I _{IN}	–	60	100	μA	V _{IN} = 3V
		–	120	200		V _{IN} = 5V
Input Current While Over Temperature Active	–	–	–	400	μA	V _{IN} = 5V
Static Drain-Source On-State Resistance	R _{DS(ON)}	–	400	600	mΩ	V _{IN} = 3V, I _D = 0.5A
		–	350	500		V _{IN} = 5V, I _D = 0.5A
Continuous Drain Current (Note 5)	I _D	0.9	–	–	A	V _{IN} = 3V; T _A = +25°C
		1.0	–	–		V _{IN} = 5V; T _A = +25°C
1.2		–	–	V _{IN} = 3V; T _A = +25°C		
1.3		–	–	V _{IN} = 5V; T _A = +25°C		
Continuous Drain Current (Note 6)						
Current Limit (Note 8)	I _{D(LIM)}	0.7	1.7	–	A	V _{IN} = 3V
		1	2.2	–		V _{IN} = 5V
Dynamic Characteristics						
Turn On Delay Time	t _{D(ON)}	–	5	–	μs	V _{DD} = 12V, I _D = 0.5A, V _{GS} = 5V
Rise Time	t _R	–	10	–		
Turn Off Delay Time	t _{D(OFF)}	–	45	–		
Fall Time	t _F	–	15	–		
Over-Temperature Protection						
Thermal Overload Trip Temperature (Note 9)	T _{JT}	+150	+175	–	°C	–
Thermal Hysteresis (Note 9)	–	–	+10	–	°C	–

- Notes:
- The drain current is restricted only when the device is in saturation (see graph 'typical output characteristic'). This allows the device to be used in the fully on state without interference from the current limit. The device is fully protected at all drain currents, as the low power dissipation generated outside saturation makes current limit unnecessary.
 - Over-temperature protection is designed to prevent device destruction under fault conditions. Fault conditions are considered as "outside" normal operating range, so this part is not designed to withstand over-temperature for extended periods.

Typical Characteristics

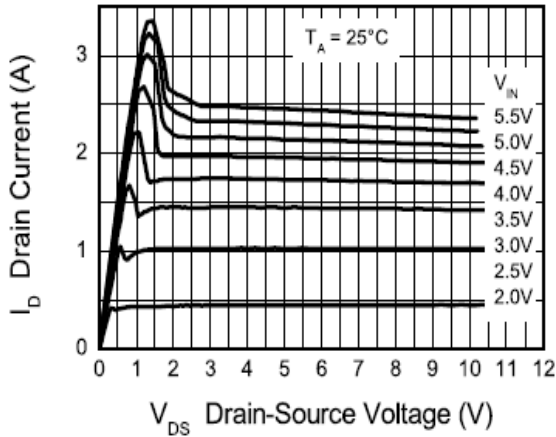

Typical Output Characteristic

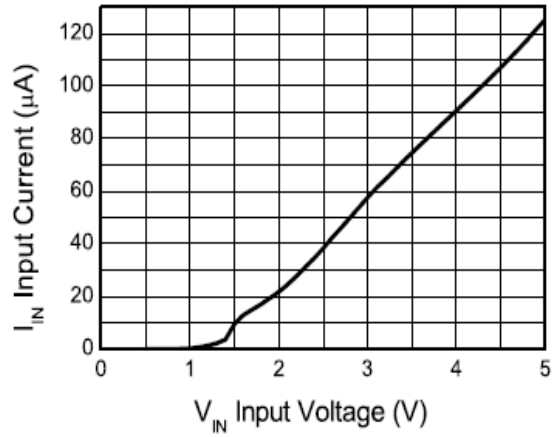

Input Current vs Input Voltage

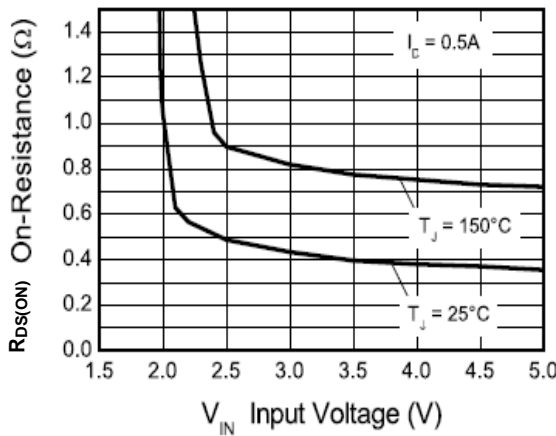

On-Resistance vs Input Voltage

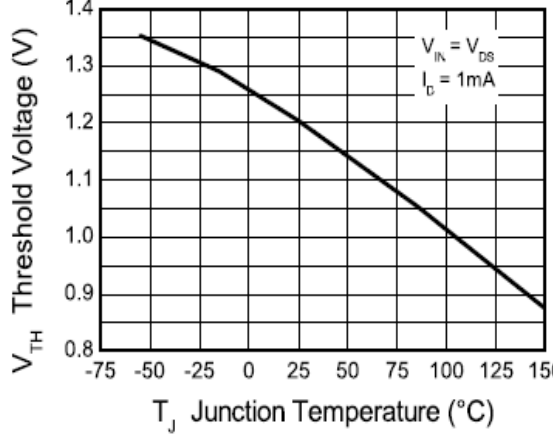

Threshold Voltage vs Temperature

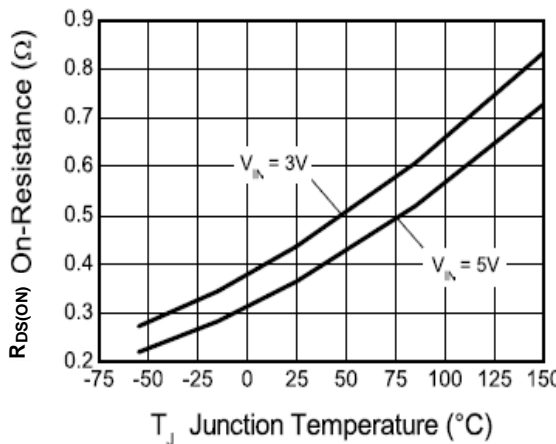

On-Resistance vs Temperature

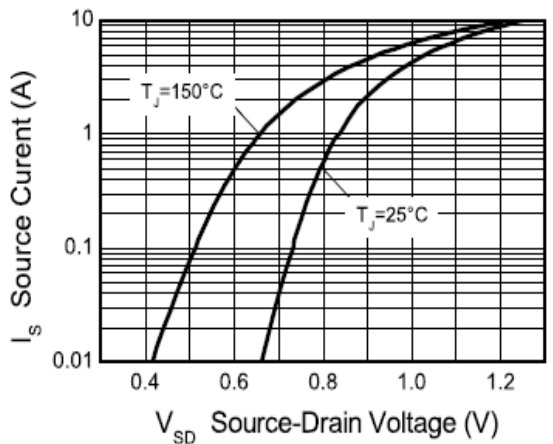

Reverse Diode Characteristic

Typical Characteristics (Cont.)

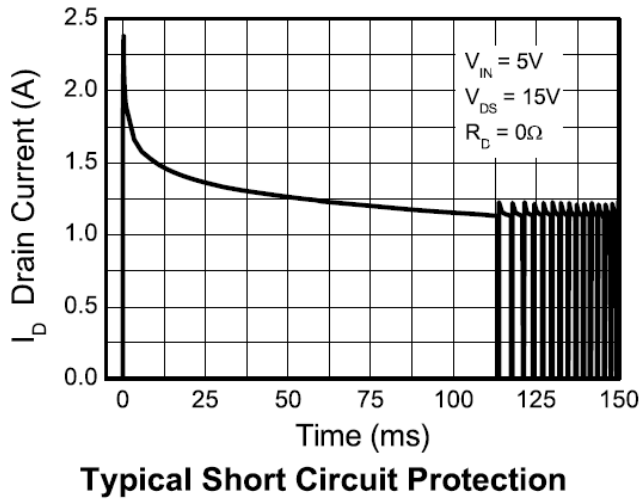
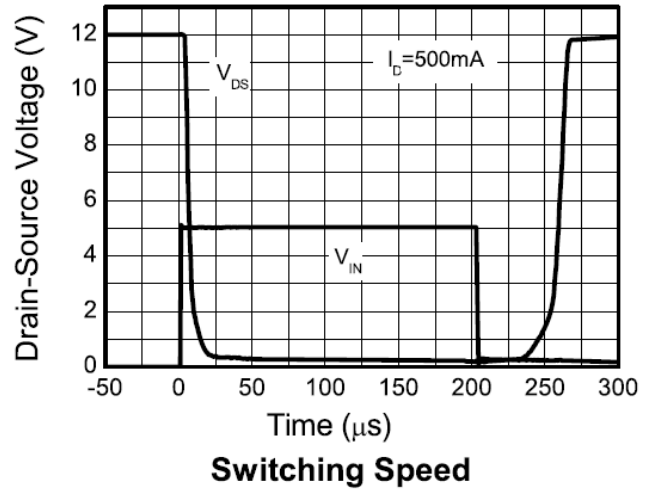
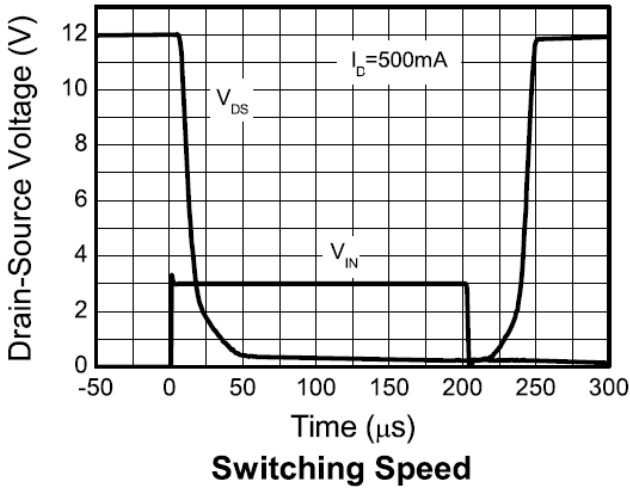

Package Outline Dimensions

Please see <http://www.diodes.com/package-outlines.html> for the latest version.

SOT223 (Type DN)

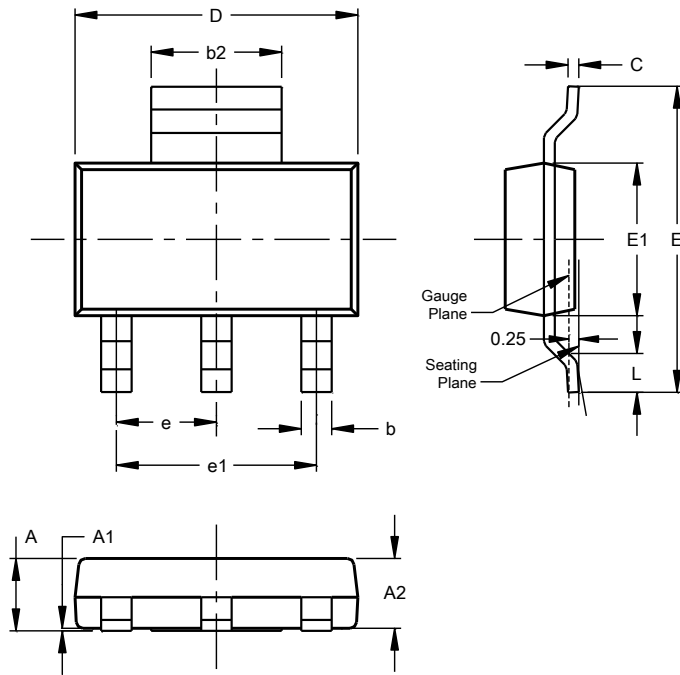

SOT223 (Type DN)			
Dim	Min	Max	Typ
A	--	1.70	--
A1	0.01	0.15	--
A2	1.50	1.68	1.60
b	0.60	0.80	0.70
b2	2.90	3.10	--
c	0.20	0.32	--
D	6.30	6.70	--
E	6.70	7.30	--
E1	3.30	3.70	--
e	--	--	2.30
e1	--	--	4.60
L	0.85	--	--
All Dimensions in mm			

Suggested Pad Layout

Please see <http://www.diodes.com/package-outlines.html> for the latest version.

SOT223 (Type DN)

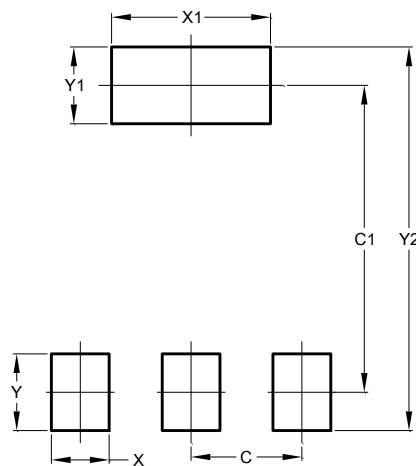

Dimensions	Value (in mm)
C	2.30
C1	6.40
X	1.20
X1	3.30
Y	1.60
Y1	1.60
Y2	8.00

IMPORTANT NOTICE

DIODES INCORPORATED MAKES NO WARRANTY OF ANY KIND, EXPRESS OR IMPLIED, WITH REGARDS TO THIS DOCUMENT, INCLUDING, BUT NOT LIMITED TO, THE IMPLIED WARRANTIES OF MERCHANTABILITY AND FITNESS FOR A PARTICULAR PURPOSE (AND THEIR EQUIVALENTS UNDER THE LAWS OF ANY JURISDICTION).

Diodes Incorporated and its subsidiaries reserve the right to make modifications, enhancements, improvements, corrections or other changes without further notice to this document and any product described herein. Diodes Incorporated does not assume any liability arising out of the application or use of this document or any product described herein; neither does Diodes Incorporated convey any license under its patent or trademark rights, nor the rights of others. Any Customer or user of this document or products described herein in such applications shall assume all risks of such use and will agree to hold Diodes Incorporated and all the companies whose products are represented on Diodes Incorporated website, harmless against all damages.

Diodes Incorporated does not warrant or accept any liability whatsoever in respect of any products purchased through unauthorized sales channel. Should Customers purchase or use Diodes Incorporated products for any unintended or unauthorized application, Customers shall indemnify and hold Diodes Incorporated and its representatives harmless against all claims, damages, expenses, and attorney fees arising out of, directly or indirectly, any claim of personal injury or death associated with such unintended or unauthorized application.

Products described herein may be covered by one or more United States, international or foreign patents pending. Product names and markings noted herein may also be covered by one or more United States, international or foreign trademarks.

This document is written in English but may be translated into multiple languages for reference. Only the English version of this document is the final and determinative format released by Diodes Incorporated.

LIFE SUPPORT

Diodes Incorporated products are specifically not authorized for use as critical components in life support devices or systems without the express written approval of the Chief Executive Officer of Diodes Incorporated. As used herein:

A. Life support devices or systems are devices or systems which:

1. are intended to implant into the body, or
2. support or sustain life and whose failure to perform when properly used in accordance with instructions for use provided in the labeling can be reasonably expected to result in significant injury to the user.

B. A critical component is any component in a life support device or system whose failure to perform can be reasonably expected to cause the failure of the life support device or to affect its safety or effectiveness.

Customers represent that they have all necessary expertise in the safety and regulatory ramifications of their life support devices or systems, and acknowledge and agree that they are solely responsible for all legal, regulatory and safety-related requirements concerning their products and any use of Diodes Incorporated products in such safety-critical, life support devices or systems, notwithstanding any devices- or systems-related information or support that may be provided by Diodes Incorporated. Further, Customers must fully indemnify Diodes Incorporated and its representatives against any damages arising out of the use of Diodes Incorporated products in such safety-critical, life support devices or systems.

Copyright © 2018, Diodes Incorporated

www.diodes.com