

**TABLE OF CONTENTS**

Features .....	1	Thermal Resistance .....	5
Enhanced Product Features .....	1	ESD Caution.....	5
Applications.....	1	Pin Configuration and Function Descriptions.....	6
Functional Block Diagram .....	1	Typical Performance Characteristics .....	7
General Description .....	1	Outline Dimensions .....	9
Revision History .....	2	Ordering Guide .....	9
Specifications.....	3		
Absolute Maximum Ratings.....	5		

**REVISION HISTORY**

**4/2018—Revision 0: Initial Release**

## SPECIFICATIONS

$T_A = 25^\circ\text{C}$ , supply voltage ( $V_{\text{SUPPLY}}$ ) = 3.3 V, x-axis acceleration and y-axis acceleration = 0 g, z-axis acceleration = 1 g, and full-scale range =  $\pm 10$  g, unless otherwise noted.

Table 1.

Parameter	Test Conditions/Comments	Min	Typ	Max	Unit
<b>SENSOR INPUT</b>					
Output Full-Scale Range (FSR)	Each axis Supports two ranges		$\pm 10/\pm 40$		g
Resonant Frequency <sup>1</sup>			5.5		kHz
Nonlinearity	$\pm 10$ g		0.1		%
Cross Axis Sensitivity			1		%
<b>SENSITIVITY</b>					
Sensitivity at $X_{\text{OUT}}$ , $Y_{\text{OUT}}$ , and $Z_{\text{OUT}}$	Ratiometric to $V_{1\text{P8ANA}}$ $\pm 10$ g $\pm 40$ g	73.6 18.4	80 20	86.4 21.6	mV/g mV/g
Sensitivity Change Due to Temperature	$T_A = -55^\circ\text{C}$ to $+125^\circ\text{C}$		$\pm 0.01$		%/ $^\circ\text{C}$
<b>0 g OFFSET</b>					
0 g Output for $X_{\text{OUT}}$ , $Y_{\text{OUT}}$ , and $Z_{\text{OUT}}$	Each axis, $\pm 10$ g Referred to $V_{1\text{P8ANA}}/2$	-375	$\pm 125$	+375	mg
0 g Offset vs. Temperature (X-Axis, Y-Axis, and Z-Axis) <sup>2</sup>	$T_A = -55^\circ\text{C}$ to $+125^\circ\text{C}$	-0.75	$\pm 0.5$	+0.75	mg/ $^\circ\text{C}$
Vibration Rectification Error (VRE) <sup>3</sup>	Offset due to 7.5 g rms vibration, $\pm 10$ g range, in a 1 g orientation		<0.1		g
<b>NOISE DENSITY</b>					
X-Axis, Y-Axis, and Z-Axis	$\pm 10$ g		80		$\mu\text{g}/\sqrt{\text{Hz}}$
Velocity Random Walk	X-axis and y-axis Z-axis		45 65		$\mu\text{m}/\text{sec}/\sqrt{\text{Hr}}$ $\mu\text{m}/\text{sec}/\sqrt{\text{Hr}}$
<b>BANDWIDTH</b>					
Internal Low-Pass Filter Frequency	Fixed frequency, 50% response attenuation		1500		Hz
<b>SELF TEST</b>					
Output Change Z-Axis	$\pm 10$ g range		1.25		g
<b>POWER SUPPLY</b>					
Voltage Range					
$V_{\text{SUPPLY}}$ <sup>4</sup>		2.25	2.5	3.6	V
Digital Interface Supply Voltage ( $V_{\text{DDIO}}$ )		$V_{1\text{P8DIG}}$	2.5	3.6	V
Analog Supply ( $V_{1\text{P8ANA}}$ ), Digital Supply ( $V_{1\text{P8DIG}}$ ) with Internal Low Dropout (LDO) Regulator Bypassed	$V_{\text{SUPPLY}} = 0$ V	1.62	1.8	1.98	V
<b>Current</b>					
<b>Measurement Mode</b>					
$V_{\text{SUPPLY}}$ (LDO Enabled)			150		$\mu\text{A}$
$V_{1\text{P8ANA}}$ (LDO Disabled)			138		$\mu\text{A}$
$V_{1\text{P8DIG}}$ (LDO Disabled)			12		$\mu\text{A}$
<b>Standby Mode</b>					
$V_{\text{SUPPLY}}$ (LDO Enabled)			21		$\mu\text{A}$
$V_{1\text{P8ANA}}$ (LDO Disabled)			7		$\mu\text{A}$
$V_{1\text{P8DIG}}$ (LDO Disabled)			10		$\mu\text{A}$
Turn On Time <sup>5</sup>	10 g range Power-off to standby		<10 <10		ms ms
<b>OUTPUT AMPLIFIER</b>					
Swing	No load	0.03		$V_{1\text{P8ANA}} - 0.03$	V
Output Series Resistance			32		k $\Omega$

Parameter	Test Conditions/Comments	Min	Typ	Max	Unit
TEMPERATURE SENSOR					
Output at 25°C			963.3		mV
Scale Factor			3.0		mV/°C
TEMPERATURE					
Operating Temperature Range		-55		+125	°C

<sup>1</sup> The resonant frequency is a sensor characteristic. An integrated analog 1.5 kHz (-6 dB) sinc low-pass filter that cannot be bypassed limits the actual output response.

<sup>2</sup> The temperature change is -55°C to +25°C or +25°C to +125°C.

<sup>3</sup> The VRE measurement is the shift in dc offset while the device is subject to 12.5 g rms of random vibration from 50 Hz to 2 kHz. The device under test (DUT) is configured for the ±10 g range and an output data rate of 4 kHz. The VRE scales with the range setting.

<sup>4</sup> When V<sub>1PBANA</sub> and V<sub>1PBDIG</sub> are generated internally, V<sub>SUPPLY</sub> is valid. To disable the LDO and drive V<sub>1PBANA</sub> and V<sub>1PBDIG</sub> externally, connect V<sub>SUPPLY</sub> to V<sub>SS</sub>.

<sup>5</sup> Standby to measurement mode; valid when the output is within 5 mg of the final value.

## ABSOLUTE MAXIMUM RATINGS

Table 2.

Parameter	Rating
Acceleration (Any Axis, 0.1 ms)	5000 <i>g</i>
V <sub>SUPPLY</sub> , V <sub>DDIO</sub>	5.4 V
V <sub>1P8ANA</sub> , V <sub>1P8DIG</sub> Configured as Inputs	1.98 V
Digital Inputs (RANGE, ST1, ST2, STBY)	−0.3 V to V <sub>DDIO</sub> + 0.3 V
Analog Outputs (X <sub>OUT</sub> , Y <sub>OUT</sub> , Z <sub>OUT</sub> , TEMP)	−0.3 V to V <sub>1P8ANA</sub> + 0.3 V
Operating Temperature Range	−55°C to +125°C
Storage Temperature Range	−65°C to +150°C

Stresses at or above those listed under Absolute Maximum Ratings may cause permanent damage to the product. This is a stress rating only; functional operation of the product at these or any other conditions above those indicated in the operational section of this specification is not implied. Operation beyond the maximum operating conditions for extended periods may affect product reliability.

## THERMAL RESISTANCE

Thermal performance is directly linked to printed circuit board (PCB) design and operating environment. Careful attention to PCB thermal design is required.

$\theta_{JA}$  is the natural convection junction to ambient thermal resistance measured in a one cubic foot sealed enclosure.

Table 3. Thermal Resistance

Package Type	$\theta_{JA}$	Unit
E-14-1 <sup>1</sup>	42	°C/W

<sup>1</sup> Thermal impedance simulated values are based on a JEDEC 252P thermal test board with four thermal vias. See JEDEC JESD51.

## ESD CAUTION



**ESD (electrostatic discharge) sensitive device.** Charged devices and circuit boards can discharge without detection. Although this product features patented or proprietary protection circuitry, damage may occur on devices subjected to high energy ESD. Therefore, proper ESD precautions should be taken to avoid performance degradation or loss of functionality.

## PIN CONFIGURATION AND FUNCTION DESCRIPTIONS

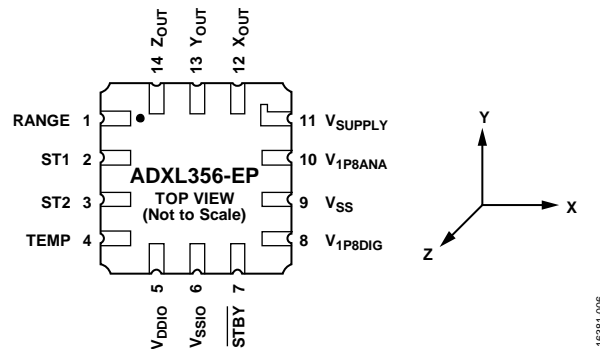

Figure 2. Pin Configuration

Table 4. Pin Function Descriptions

Pin No.	Mnemonic	Description
1	RANGE	Range Selection Pin. Set this pin to ground to select the $\pm 10\text{ g}$ range, or set RANGE to $V_{DDIO}$ to select the $\pm 40\text{ g}$ range.
2	ST1	Self Test Pin 1. This pin enables self test mode.
3	ST2	Self Test Pin 2. This pin activates the electromechanical self test actuation.
4	TEMP	Temperature Sensor Output.
5	$V_{DDIO}$	Digital Interface Supply Voltage.
6	$V_{SSIO}$	Digital Ground.
7	$\overline{STBY}$	Standby or Measurement Mode Selection Pin. Set $\overline{STBY}$ to ground to enter standby mode, or set $\overline{STBY}$ to $V_{DDIO}$ to enter measurement mode.
8	$V_{1P8DIG}$	Digital Supply. This pin requires a decoupling capacitor. If $V_{SUPPLY}$ connects to $V_{SS}$ , supply the voltage to this pin externally.
9	$V_{SS}$	Analog Ground.
10	$V_{1P8ANA}$	Analog Supply. This pin requires a decoupling capacitor. If $V_{SUPPLY}$ connects to $V_{SS}$ , supply the voltage to this pin externally.
11	$V_{SUPPLY}$	Supply Voltage. When $V_{SUPPLY}$ equals 2.25 V to 3.6 V, $V_{SUPPLY}$ enables the internal LDO regulators to generate $V_{1P8DIG}$ and $V_{1P8ANA}$ . For $V_{SUPPLY} = V_{SS}$ , $V_{1P8DIG}$ and $V_{1P8ANA}$ are externally supplied.
12	$X_{OUT}$	X-Axis Output.
13	$Y_{OUT}$	Y-Axis Output.
14	$Z_{OUT}$	Z-Axis Output.

# TYPICAL PERFORMANCE CHARACTERISTICS

All figures include data for multiple devices and multiple lots, and they were taken in the  $\pm 10$  g range, unless otherwise noted.

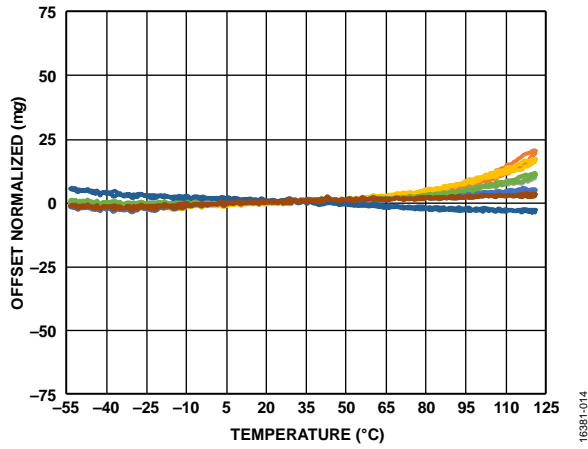

Figure 3. X-Axis Zero g Offset Normalized Relative to 25°C vs. Temperature for Multiple Devices

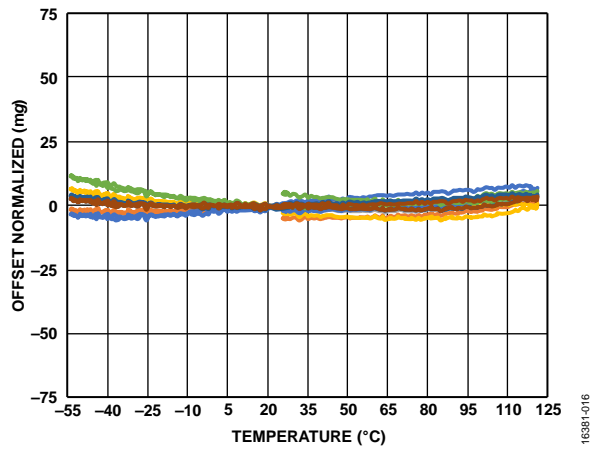

Figure 5. Z-Axis Zero g Offset Normalized Relative to 25°C vs. Temperature for Multiple Devices

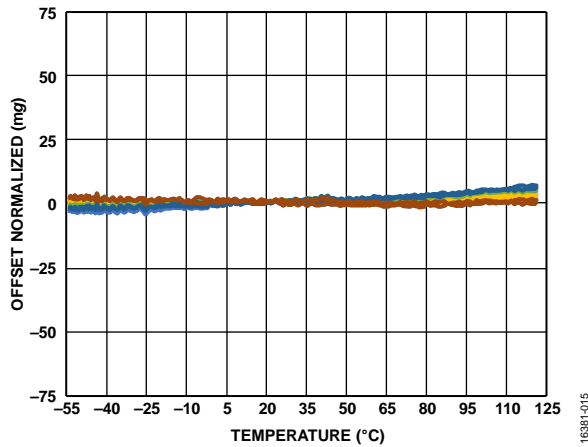

Figure 4. Y-Axis Zero g Offset Normalized Relative to 25°C vs. Temperature for Multiple Devices

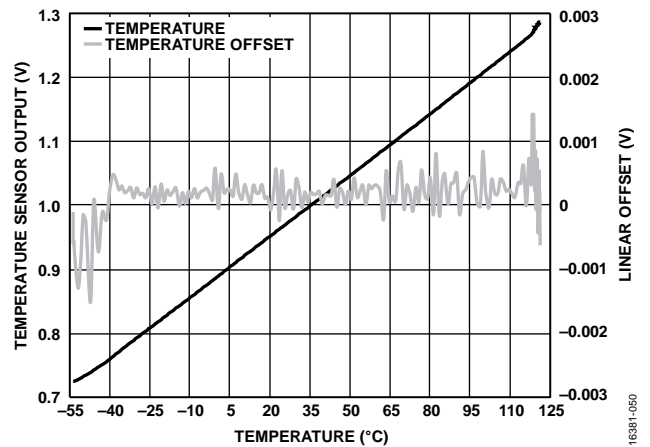
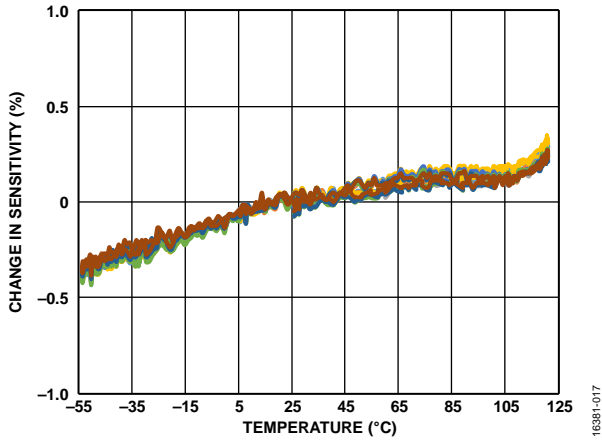
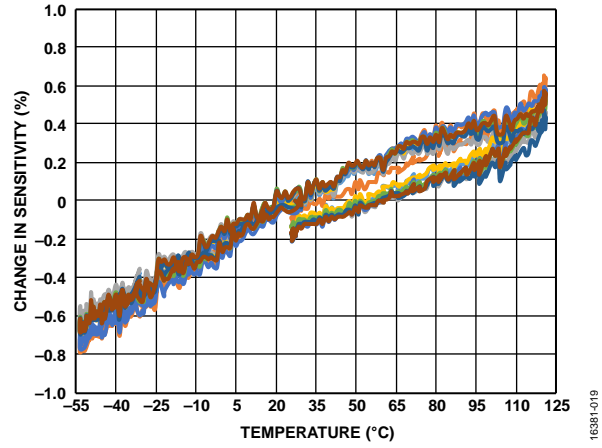

Figure 6. Temperature Sensor Output and Linear Offset vs. Temperature for Multiple Devices



16381-017

Figure 7. X-Axis Change in Sensitivity Relative to 25°C vs. Temperature for Multiple Devices



16381-019

Figure 9. Z-Axis Change in Sensitivity Relative to 25°C vs. Temperature for Multiple Devices

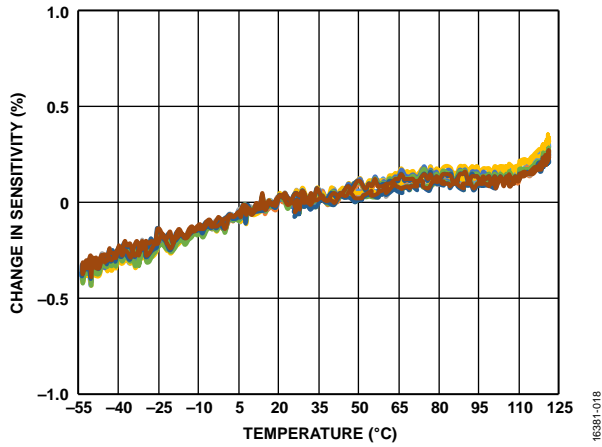

16381-018

Figure 8. Y-Axis Change in Sensitivity Relative to 25°C vs. Temperature for Multiple Devices

# OUTLINE DIMENSIONS

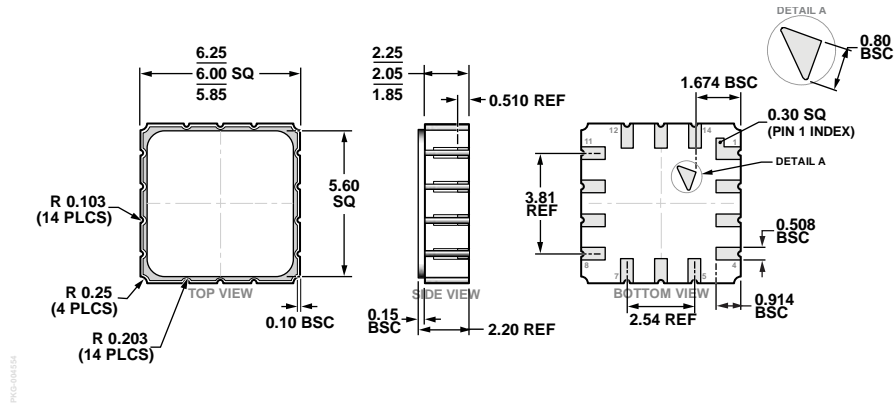

Figure 10. 14-Terminal Ceramic Leadless Chip Carrier [LCC] (E-14-1)  
Dimensions shown in millimeters

## ORDERING GUIDE

Model <sup>1</sup>	Output Mode	Measurement Range (g)	Specified Voltage (V)	Temperature Range	Package Description	Package Option
ADXL356TEZ-EP	Analog	±10, ±40	3.3	-55°C to +125°C	14-Terminal LCC	E-14-1
ADXL356TEZ-EP-RL	Analog	±10, ±40	3.3	-55°C to +125°C	14-Terminal LCC, 13" Reel	E-14-1
ADXL356TEZ-EP-RL7	Analog	±10, ±40	3.3	-55°C to +125°C	14-Terminal LCC, 7" Reel	E-14-1

<sup>1</sup> Z = RoHS Compliant Part.



# Mouser Electronics

Authorized Distributor

Click to View Pricing, Inventory, Delivery & Lifecycle Information:

[Analog Devices Inc.:](#)

[ADXL356BEZ](#) [ADXL356CEZ](#) [ADXL356BEZ-RL7](#) [ADXL356CEZ-RL7](#) [ADXL356BEZ-RL](#) [ADXL356CEZ-RL](#)  
[ADXL356TEZ-EP-RL](#) [ADXL356TEZ-EP-RL7](#) [ADXL356TEZ-EP](#) [EVAL-ADXL356CZ](#) [EVAL-ADXL356BZ](#)