

Two-PLL Clock Generator with Direct Rambus™ (Lite) Support

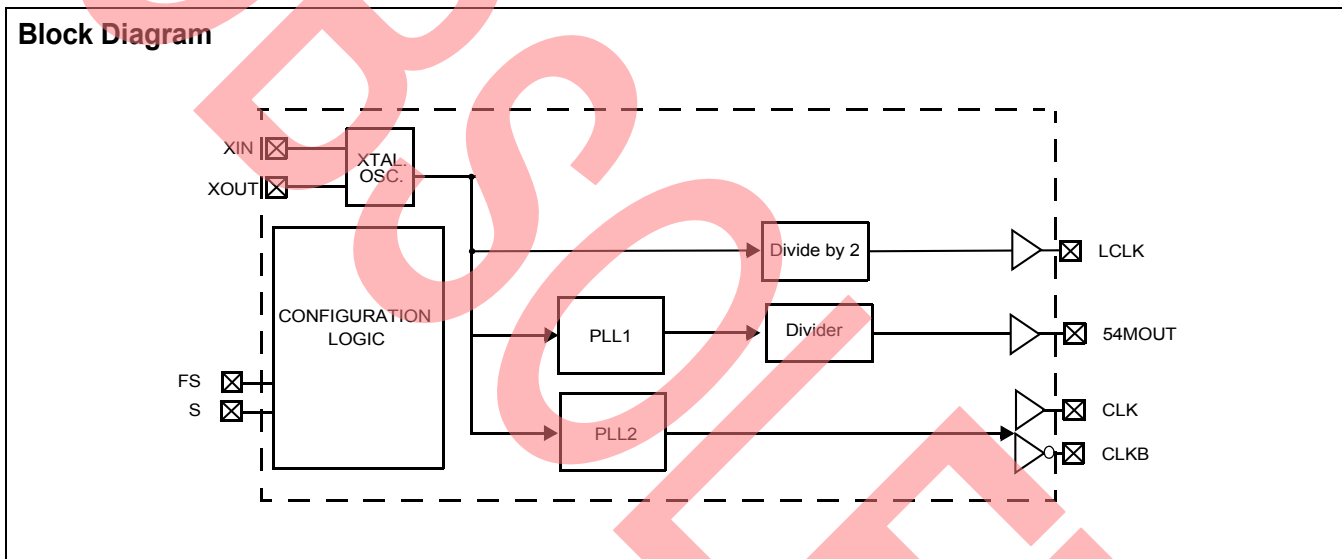
Features

- Two integrated phase-locked loops (PLLs)
- Ultra-accurate PLLs
- Direct Rambus™ clock support
- Two input selects
- 3.45V core; 3.45V, 2.5V, 1.8V, and 1.675V outputs
- 24-pin TSSOP package

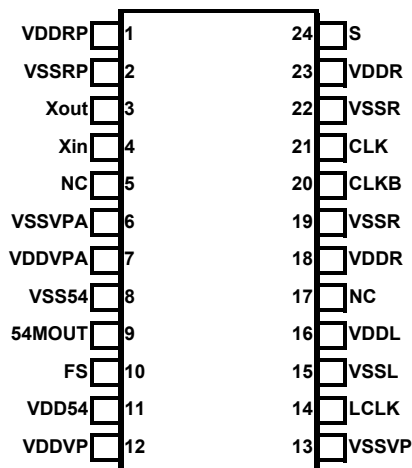
Benefits

- High-performance PLL tailored for multimedia applications
- Frequency tolerance within 1 PPM on all frequencies
- One pair of differential output drivers, identical specification to CY2212
- Selectable 54.0-/53.946-MHz output and 294.912-/393.216-MHz Rambus® output
- Supports output voltage requirements
- Industry-standard packaging saves on board space

Block Diagram



Pin Configuration



Frequency Select Tables

FS	54MOUT	Unit	PPM
0	54	MHz	0
1	53.94605395	MHz	-1

S	CLK, CLKB	Unit	PPM
0	294.912	MHz	0
1	393.216	MHz	0

LCLK	Unit	PPM
9.216	MHz	0

Pin Definitions

Name	Pin Numbers	Pin Description
V _{DDRP}	1	Power for DRCG PLL
V _{SSRP}	2	Ground for DRCG PLL
X _{out}	3	Crystal Output
X _{in}	4	Crystal Input
NC	5	Do Not Connect, Leave Floating
V _{SSVPA}	6	Analog Ground For Video PLL
V _{DDVPA}	7	Analog Power for Video PLL
V _{SS54}	8	Ground for 54MOUT
54MOUT	9	54-MHz/53.94605395-MHz Output
FS	10	Frequency Select Pin for 54MOUT (internal pull-down resistor)
V _{DD54}	11	Power for 54MOUT
V _{DDVP}	12	Power for Video PLL
V _{SSVP}	13	Ground for Video PLL
LCLK	14	LCLK Output
V _{SSL}	15	Ground for LCLK
V _{DDL}	16	Power for LCLK
NC	17	Do Not Connect, Leave Floating
V _{DDR}	18	Power for DRCG CLK/CLKB
V _{SSR}	19	Ground for DRCG CLK/CLKB
CLKB	20	Output Clock to Rambus (complement)
CLK	21	Output Clock to Rambus
V _{SSR}	22	Ground for DRCG CLK/CLKB
V _{DDR}	23	Power for DRCG CLK/CLKB
S	24	Frequency Select Pin for DRCG CLK/CLKB (internal pull-up resistor)

Absolute Maximum Conditions

(Above which the useful life may be impaired. For user guidelines; not tested.)

Supply Voltage -0.5V to +4.0V

DC Input Voltage -0.5V to + (V_{DD} + 0.5V)

Storage Temperature -65°C to +125°C

Static Discharge Voltage
(per MIL-STD-883, Method 3015) 2000V

Latch-up (per JEDEC 17) ≥ ±200 mA

Recommended Operating Conditions^[1]

Parameter	Description	Min.	Typ	Max.	Unit
V _{DDRP} , V _{DDVPA} , V _{DDVP} , V _{DDR}	Supply Voltage for PLL's, Crystal Oscillator, and 3.45V Outputs	3.15	3.45	3.6	V
V _{DD54} (2.5V)	Supply Voltage for 2.5V Outputs	2.25	2.5	2.75	V
V _{DD54} (1.675V)	Supply Voltage for 1.675V Outputs	1.6	1.675	1.75	V
V _{DDL}	Supply Voltage for 1.8V Outputs	1.6	1.8	2.0	V
t _{PU}	Power-up time for all V _{DDS} to reach minimum specified voltage (power ramps must be monotonic)	0.05		500	ms
T _A	Operating Temperature, Ambient	0		+85	°C
C _{LOAD_54MOUT}	Max. Load Capacitance, CMOS Output			15	pF
f _{REF}	External Reference Crystal		18.432		MHz

Electrical Specifications

Parameter	Description	Conditions	Min.	Typ.	Max.	Unit
I _{OH} ^[2]	Output High Current, 2.5V outputs ^[3]	V _{OH} = V _{DD} - 0.5, V _{DD} = 2.5V	8	16		mA
	Output High Current, 1.8V outputs ^[3]	V _{OH} = V _{DD} - 0.5, V _{DD} = 1.8V	6	12		mA
	Output High Current, 1.675V outputs ^[3]	V _{OH} = V _{DD} - 0.5, V _{DD} = 1.675V	5	10		mA
I _{OL} ^[2]	Output Low Current, 2.5V outputs ^[3]	V _{OL} = 0.5V, V _{DD} = 2.5V	8	16		mA
	Output Low Current, 1.8V outputs ^[3]	V _{OL} = 0.5V, V _{DD} = 1.8V	6	12		mA
	Output Low Current, 1.675V outputs ^[3]	V _{OL} = 0.5V, V _{DD} = 1.675V	5	10		mA
C _{XTAL}	Crystal Load Capacitance ^[3]	Total effective load of internal load caps		11 ^[4]		pF
C _{LOAD_IN}	Input Pin Capacitance ^[3]	Except crystal pins		7		pF
V _{IH}	HIGH-Level Input Voltage	CMOS levels, % of V _{DDRP} /V _{DDVPA} /V _{DDVP}	70%			V _{DD}
V _{IL}	LOW-Level Input Voltage	CMOS levels, % of V _{DDRP} /V _{DDVPA} /V _{DDVP}			30%	V _{DD}
R _{I_FS}	FS Input Resistor	Pull-down resistor on FS	60	150	225	kΩ
R _{I_S}	S Input Resistor	Pull-up resistor on S	10		100	kΩ
I _{DD}	Total Power Supply Current	Sum of all supply currents			125	mA

Direct Rambus Electrical Specifications^[3]

Parameter	Description	Min.	Typ.	Max.	Unit
V _{CM}	Differential output common-mode voltage	1.35		1.75	V
V _X	Differential output crossing-point voltage ^[5]	1.25		1.85	V
V _{COS}	Output Voltage swing (p-p single-ended) ^[6]	0.4		0.7	V
V _{COH}	Output high voltage			2.1	V
V _{COL}	Output low voltage	1.0			V
r _{OUT}	Output dynamic resistance (at pins) ^[7]	12		50	Ω

Notes:

1. Unless otherwise noted, Electrical and Switching Characteristics are guaranteed across these operating conditions.
2. LCLK and 54MOUT outputs only.
3. Guaranteed by design, not 100% tested.
4. Identical Crystal Load Capacitance as CY2212ZC-2. Use the same crystal and X_{IN} / X_{OUT} board layout as implemented with the original crystal-driven CY2212ZC-2.
5. Differential output crossing point voltages shown in Figure 1.
6. V_{COS} = V_{OH} - V_{OL}.
7. r_{OUT} = ΔV_O / ΔI_O. This is defined at the output pins, not at the measurement point of Figure 9.

Switching Characteristics^[3]

Parameter	Description	Conditions	Min.	Typ.	Max.	Unit
F _{PPM}	Frequency Error	Part to Part, does not include PCB variation ^[8]		±5	±10	PPM
		Over commercial temperature range ^[9]		±2	±5	PPM
DC	Output Duty Cycle	Duty cycle for all outputs, measured at V _{DD} /2	45	50	55	%
t _{3_54, 2.5}	54MOUT Rising Edge Slew Rate	20% to 80% of V _{DD54} , V _{DD54} = 2.5V	0.75	1.2	4.0	V/ns
t _{3_54, 1.675}	54MOUT Rising Edge Slew Rate	20% to 80% of V _{DD54} , V _{DD54} = 1.675V	0.35	0.5	2.5	V/ns
t _{4_54, 2.5}	54MOUT Falling Edge Slew Rate	80% to 20% of V _{DD54} , V _{DD54} = 2.5V	0.75	1.2	4.0	V/ns
t _{4_54, 1.675}	54MOUT Falling Edge Slew Rate	80% to 20% of V _{DD54} , V _{DD54} = 1.675V	0.35	0.5	2.5	V/ns
t _{CR, t_{CF}}	CLK/CLKB Rise and Fall Times	20% to 80% of output voltage	160		400	ps
t _{CR-CF}	CLK/CLKB Rise and Fall Difference ^[10]	20% to 80% of output voltage			100	ps
t ₅	Lock Time ^[11]	PLL lock time from power-up		1.0	3.0	ms

Phase Noise Specifications

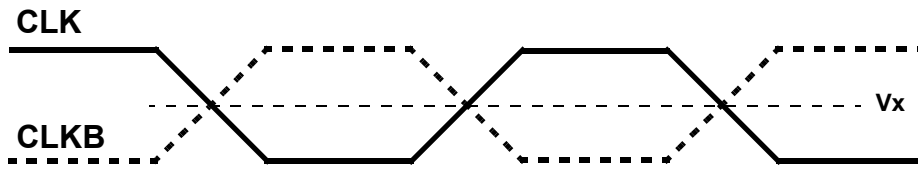
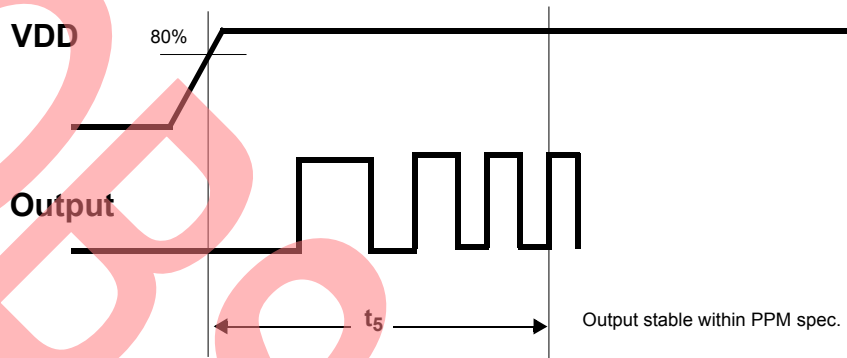
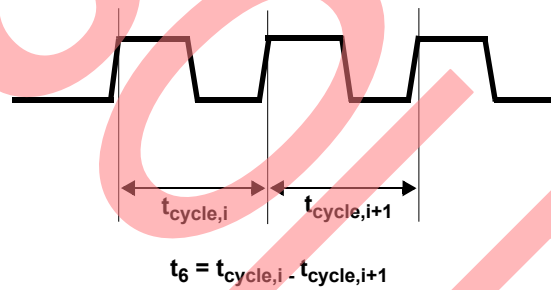
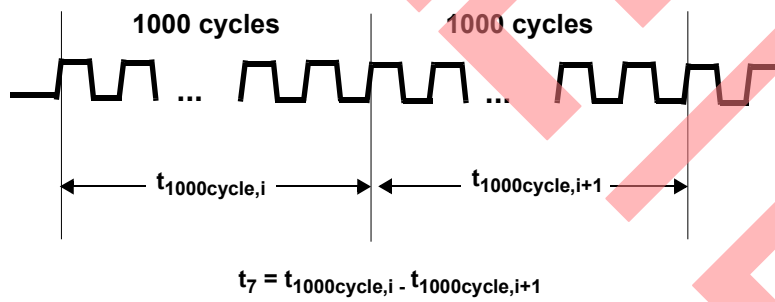
Parameter	Description	Conditions	Min.	Typ.	Max.	Unit
	Phase Noise	54 MHz at 10-kHz offset		-95		dBc
	Phase Noise	53.946 MHz at 10-kHz offset		-92		dBc

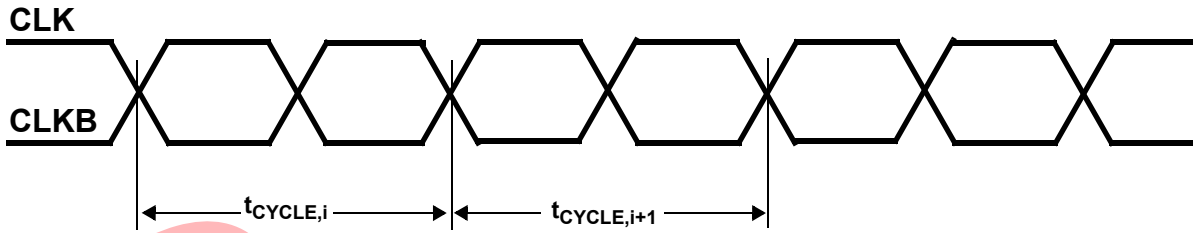
Jitter Specifications^[3]

Parameter	Description	Conditions	Typ.	Max.	Unit
t _{6_LCLK}	LCLK Jitter ^[12]	Cycle-Cycle Jitter – 9.216 MHz		250	ps
t _{6_54, 2.5}	54MOUT Jitter ^[12]	Cycle-Cycle Jitter – 54 MHz, V _{DD} = 2.5V		150	ps
		Cycle-Cycle Jitter – 53.946 MHz, V _{DD} = 2.5V		150	ps
t _{6_54, 1.675}		Cycle-Cycle Jitter – 54 MHz, V _{DD} = 1.675V		250	ps
		Cycle-Cycle Jitter – 53.946 MHz, V _{DD} = 1.675V		250	ps
t _{7_LCLK}	LCLK 1000 Cycle Jitter ^[13]	1000 Cycle Jitter – 9.216 MHz		250	ps
t _{7_54}	54MOUT 1000 Cycle Jitter ^[13]	1000 Cycle Jitter – 54 MHz,		400	ps
		1000 Cycle Jitter – 53.946 MHz,		400	ps
t ₈	CLK/CLKB 1–6 Cycle Jitter ^[14]	Cycle-Cycle Jitter, 1–6 Cycles, 400 MHz		50	ps
		Cycle-Cycle Jitter, 1–6 Cycles, 300 MHz		70	ps
t ₉	CLK/CLKB Long-term Jitter ^[15]	Long-term Jitter, 400 MHz		300	ps
		Long-term Jitter, 300 MHz		400	ps
t ₁₀	CLK/CLKB Duty Cycle Error ^[16]	Cycle-Cycle Duty Cycle Error, 400 MHz		50	ps
		Cycle-Cycle Duty Cycle Error, 300 MHz		70	ps

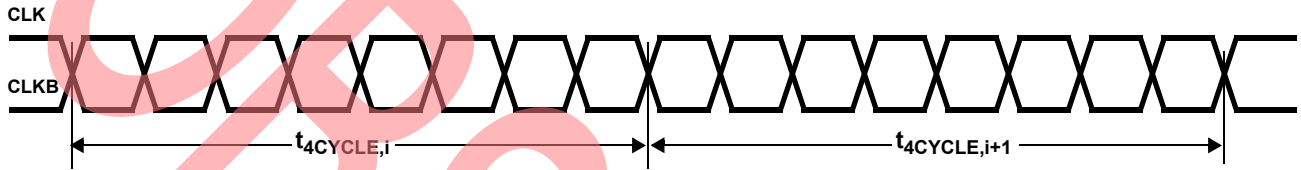
Notes:

8. Tested across three lots on same board, PCB boards can vary more than ± 5 PPM.
9. Crystal should not be heated for this test, only IC.
10. Measured on same pin of a single device.
11. Lock Time shown in *Figure 2*.
12. LCLK and 54MOUT Cycle-Cycle Jitter shown in *Figure 3*.
13. LCLK and 54MOUT 1000 Cycle Jitter shown in *Figure 4*.
14. CLK/CLKB 1-6 Cycle Jitter specification is absolute value of worst case deviation, and is shown in *Figure 5* and *Figure 6*.
15. CLK/CLKB Long Term Jitter shown in *Figure 7*.
16. CLK/CLKB Duty Cycle Error shown in *Figure 8*.

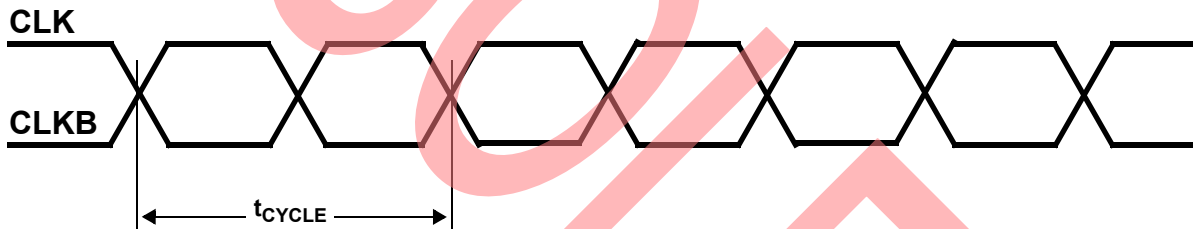

Figure 1. Direct Rambus Crossing Point Voltage

Figure 2. PLL Lock Time

Figure 3. 54MOUT, LCLK Cycle-to-Cycle Jitter

Figure 4. 54MOUT, LCLK 1000 Cycle Jitter



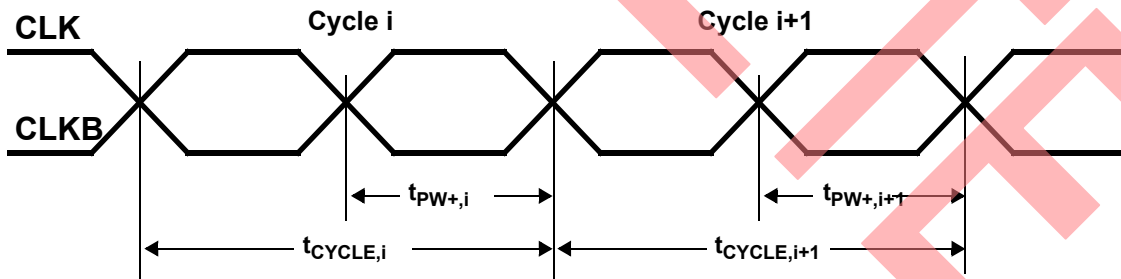
$$t_8 = t_{CYLCE,i} - t_{CYCLE,i+1} \text{ over 10000 consecutive cycles}$$

Figure 5. CLK, CLKB Cycle-to-Cycle Jitter


$$t_8 = t_{4CYCLE,i} - t_{4CYCLE,i+1} \text{ over 10000 consecutive cycles}$$

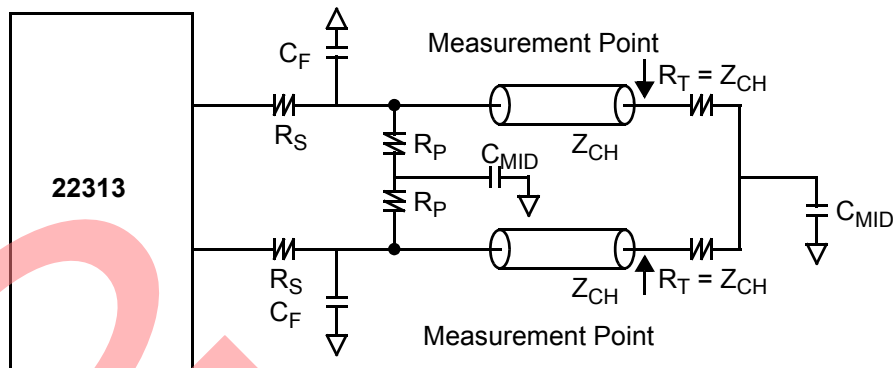
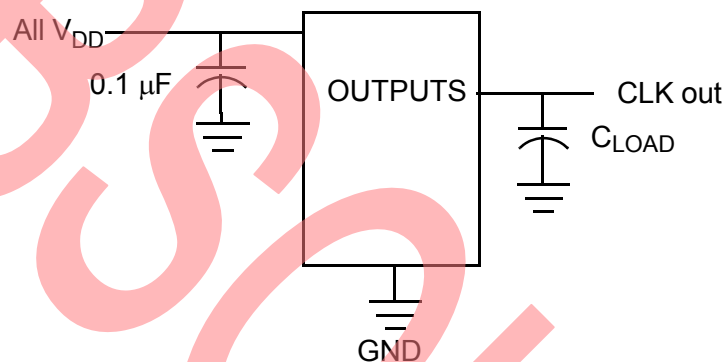
Figure 6. CLK, CLKB 4-Cycle-to-Cycle Jitter


$$t_9 = t_{CYCLE,max} - t_{CYCLE,min} \text{ over 10000 cycles}$$

Figure 7. CLK, CLKB Long-term Jitter


$$t_{10} = t_{PW+,i} - t_{PW+,i+1}$$

Figure 8. CLK, CLKB Duty Cycle Error


Figure 9. Direct Rambus Test Circuit

Figure 10. LCLK, 54MOUT Output Test Circuits
Table 1. Direct Rambus Test Circuit Component Values

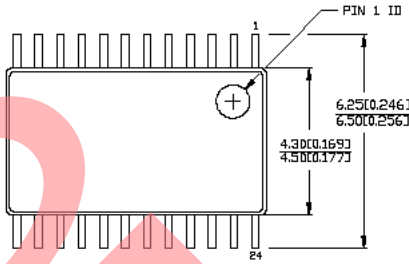
Parameter	Description	Value	Tolerance	Unit
R_S	Series Resistor	68	±5%	Ω
R_P	Parallel Resistor	39	±5%	Ω
C_F	Edge-Rate Filter Capacitor ^[17]	15	±10%	pF
C_{MID}	AC Ground Capacitor	0.01	±20%	μF

Ordering Information

Ordering Code	Package Name	Package Type	Operating Range	Operating Voltages
Lead Free				
CY22313ZXC	Z24	24-lead TSSOP	Commercial ($T_A = 0^\circ C$ to $85^\circ C$)	3.45
CY22313ZXCT	Z24	24-lead TSSOP – Tape and Reel	Commercial ($T_A = 0^\circ C$ to $85^\circ C$)	3.45

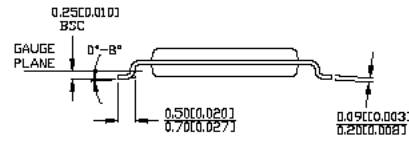
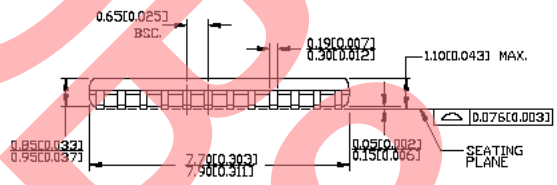
Notes:

 17. C_F is OPTIONAL filter capacitor for adjusting edge rates and EMI. No filter capacitors are used for characterization and test data.

Package Drawing and Dimensions
24-Lead Thin Shrunken Small Outline Package (4.40-mm Body) Z24


DIMENSIONS IN MILLIMETERS MIN. MAX.
 REFERENCE JEDEC MO-153

PART #	
Z24.173	STANDARD PKG.
ZZ24.173	LEAD FREE PKG.



51-85119 *B

Rambus is a registered trademark, and Direct Rambus is a trademark, of Rambus Inc. All product and company names mentioned in this document are the trademarks of their respective holders.

Document History Page

Document Title: CY22313 Two-PLL Clock Generator with Direct Rambus™ (Lite) Support				
Document Number: 38-07434				
REV.	ECN NO.	Issue Date	Orig. of Change	Description of Change
**	117092	07/02/02	CKN	New Data Sheet
*A	121365	11/15/02	CKN	Reordered Pin Description table Changed all 3.3V references to 3.45V Changed RI_FS min. spec to 60 KOhms Changed note 4 Inserted max. spec for Edge Rates Reduced min. spec for Edge Rates on 1.8V and 1.675V outputs Inserted phase noise specifications Created separate specs for Jitter, depending on output voltage Correctly specified CF in <i>Table 1</i>
*B	121773	02/17/03	CKN	Added t _{PJ} row to the Recommended Operating Conditions table
*C	125454	05/19/03	CKN	Updated Switching Characteristics table Added CY22313LF ordering information and corresponding note
*D	127393	06/12/03	RGL	Removed "PRELIMINARY" Rephrased Note 18 to provide clarity on marking
*E	239051	See ECN	RGL	Corrected the Lead Free Coding in the Ordering Information table
*F	2897294	03/22/10	KVM	Removed part numbers CY22313ZC and CY22313ZCT from ordering information table. Updated package diagram. Updated copyright section.
*G	3041845	09/29/2010	KVM	Obsolete spec.

Sales, Solutions, and Legal Information

Worldwide Sales and Design Support

Cypress maintains a worldwide network of offices, solution centers, manufacturer's representatives, and distributors. To find the office closest to you, visit us at [Cypress Locations](#).

Products

Automotive	cypress.com/go/automotive
Clocks & Buffers	cypress.com/go/clocks
Interface	cypress.com/go/interface
Lighting & Power Control	cypress.com/go/powerpsoc
	cypress.com/go/plc
Memory	cypress.com/go/memory
Optical & Image Sensing	cypress.com/go/image
PSoC	cypress.com/go/psoc
Touch Sensing	cypress.com/go/touch
USB Controllers	cypress.com/go/USB
Wireless/RF	cypress.com/go/wireless

PSoC Solutions

psoc.cypress.com/solutions
[PSoC 1](#) | [PSoC 3](#) | [PSoC 5](#)

Mouser Electronics

Authorized Distributor

Click to View Pricing, Inventory, Delivery & Lifecycle Information:

[Cypress Semiconductor:](#)

[CY22313ZXC](#) [CY22313ZXCT](#)