

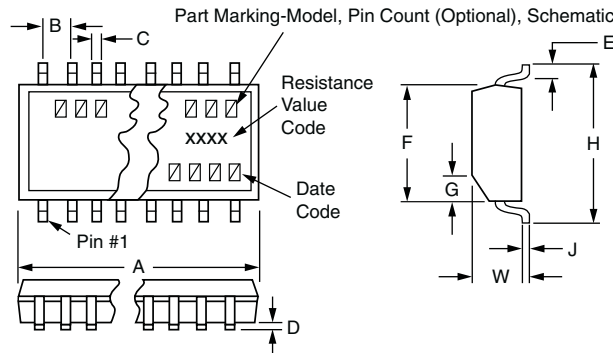

STANDARD ELECTRICAL SPECIFICATIONS		
TEST	SPECIFICATIONS	CONDITIONS
Material	Tantalum nitride	-
Pin/Lead Number	16, 20, 24	-
Resistance Range	10 Ω to 47 kΩ	Per E-24 table
TCR: Absolute	± 100 ppm/°C	-55 °C to +125 °C
TCR: Tracking	n/a	-
Tolerance: Absolute	± 5 % standard (± 2 % available) ± 1 % standard (check factory)	Per E-24 table Per E-96 table
Tolerance: Ratio	NA	-
Power Rating: Resistor	100 mW max.	At +70 °C
Power Rating: Package	16 = 1.0 W, 20 = 1.2 W, 24 = 1.4 W	0 °C to +70 °C
Stability: Absolute	-	-
Stability: Ratio	-	-
Voltage Coefficient	5 ppm/V (typical)	-
Working Voltage	50 V <sub>DC</sub>	-
Operating Temperature Range	-55 °C to +125 °C	-
Storage Temperature Range	-55 °C to +150 °C	-
Noise	< -35 dB	-
Thermal EMF	-	-
Shelf Life Stability: Absolute	-	-
Shelf Life Stability: Ratio	-	-

**DIMENSIONS AND IMPRINTING** in inches (millimeters)



DIMENSION	VTSR-xxxx	VSSR-xxxx	VSOR-xxxx
A - 16 PIN	0.206 ± 0.003 (5.23 ± 0.08)	0.193 ± 0.004 (4.90 ± 0.010)	0.390 ± 0.010 (9.91 ± 0.25)
A - 20 PIN	0.256 ± 0.003 (6.50 ± 0.08)	0.341 ± 0.003 (8.66 ± 0.08)	NA
A - 24 PIN	0.306 ± 0.003 (7.77 ± 0.08)	0.341 ± 0.003 (8.66 ± 0.08)	NA
B (Ref.)	0.0256 (0.65)	0.025 (0.64)	0.050 (1.27)
C (Ref.)	0.0087 (0.22)	0.010 (0.25)	0.016 (0.41)
D	0.004 (0.10)	0.006 (0.15)	0.008 (0.20)
E (Typ.)	0.024 (0.61)	0.025 (0.64)	0.030 (0.76)
F	0.173 ± 0.003 (4.39 ± 0.08)	0.154 ± 0.003 (3.91 ± 0.08)	0.152 ± 0.003 (3.86 ± 0.08)
G	0.015 × 45° (0.38)	0.015 × 45° (0.38)	0.015 × 45° (0.38)
H	0.252 ± 0.005 (6.40 ± 0.13)	0.236 ± 0.008 (5.99 ± 0.20)	0.236 ± 0.005 (5.99 ± 0.13)
J (Ref.)	0.005 (0.13)	0.010 (0.25)	0.008 (0.20)
W	0.043 ± 0.005 (1.09 ± 0.13)	0.064 ± 0.005 (1.63 ± 0.13)	0.064 ± 0.005 (1.63 ± 0.13)

**MARKING**

MODEL	PIN COUNT (Optional)	SCHEMATIC	RESISTANCE	RESISTANCE	DATE CODE
VXXX	XX	XX	XXXX	XXX	XXXX
VSOR	16	01, 03,	1 % RESISTANCE	OR 1 %, 2 %, 5 % RESISTANCE e.g.: 103 = 10K The first 2 digits are significant figures, the last digit specifies the number of zeros to follow.	
VSSR	20	05 or 47	e.g.: 43R2		
VTSR	24		4 digits are used to express ohmic values only less than 100 Ω. R is used to designate the decimal position		



MECHANICAL SPECIFICATIONS	
Resistive Element	Tantalum nitride
Substrate Material	Silicon
Body	Molded epoxy
Terminals	Copper alloy
Plating	100 % matte tin
Lead Coplanarity	0.0005"
Marking Resistance to Solvents	Permanency testing per MIL-STD-202, method 215

PACKAGING INFORMATION			
MODEL	LEADS	TAPE AND REEL	TUBES
VTSR (TSSOP)	16	2500	94
	20	2500	74
	24	2500	62
VSSR (QSOP)	16	2500	98
	20	2500	55
	24	2500	55
VSOR (SOIC)	16	2500	48

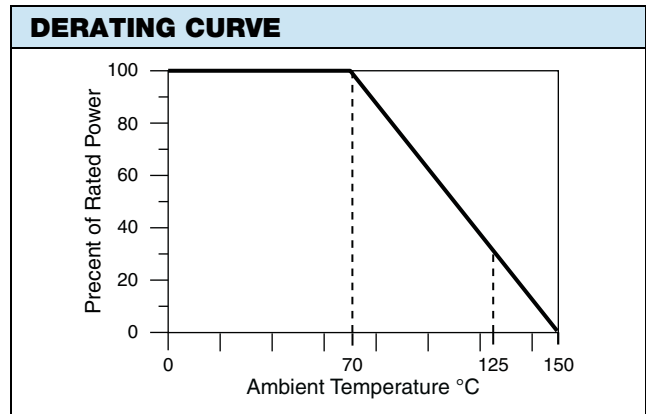

### GLOBAL PART NUMBER INFORMATION

New Global Part Numbering: **VTSR1601103JTF**

V	T	S	R	1	6	0	1	1	0	3	J	T	F			
V	S	O	R	1	6	0	5	3	3	1	4	7	1	G	T	F

GLOBAL MODEL	PIN COUNT	SCHEMATIC	RESISTANCE (3, 4 or 6 digits)	TOLERANCE	PACKAGING
<b>VTSR</b> <b>VSSR</b> <b>VSOR</b> Lead (Pb)-free (e3) date code > 2705	<b>20</b> (not VSOR) <b>24</b> (not VSOR)	<b>01</b> (bussed) <b>03</b> (isolated)	XXX: ≥ 100R and all 1 %, 2 % and 5 % First 2 digits are significant figures. Last digit specifies number of zeros to follow. XXXX: < 100R 1 % First 3 digits are significant figures. Last digit specifies number of zeros to follow.	<b>F</b> = 1.0 % <b>G</b> = 2.0 % <b>J</b> = 5.0 %	<b>TAPE AND REEL</b> <b>TF</b> = Full reel 2500 <b>UF</b> = Tubed
	<b>16</b> (not VTSR) <b>20</b> (not VSOR)	<b>05</b> (terminator) <b>47</b> (terminator)	xxx xxx First 2 digits are significant figures. Last digit specifies number of zeros.	<b>G</b> = 2.0 % <b>J</b> = 5.0 %	

Historical Part Number example: **VSSR2001102GT/R** (for reference purposes only)

VSSR	20	01	102	G	T/R
MODEL	PIN COUNT	SCHEMATIC	RESISTANCE	TOLERANCE	PACKAGING



### Vishay Dale Thin Film Land Patterns

#### 1. Scope

This technical note provides sample land patterns for Vishay Dale Thin Film SMT resistive products. The following drawings are based on IPC-SM-782 Surface Mount Design and Land Pattern Standard. These drawings are for reference only Vishay Thin Film recommends that the user contacts their PC board supplier for actual land patterns required. The pads are intended for lead (Pb)-free and tin / lead solder types.

#### 2. Product Series

Thin Film Surface Mount Chip Resistors (FC, L, P, PTN, PLT, PLTT, PLTU, PAT, PATT, PNM, M/D55342 QPL Series)

**0402 Land Pattern**

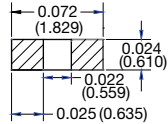

**0502 Land Pattern**

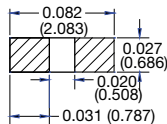

**0505 Land Pattern**

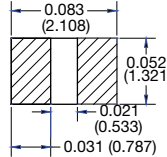

**0603 Land Pattern**

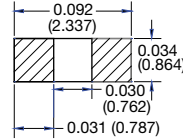

**0705 Land Pattern**

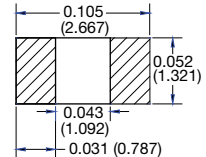

**1005 Land Pattern**

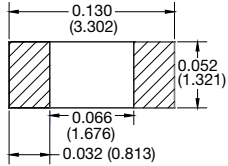

**1010 Land Pattern**

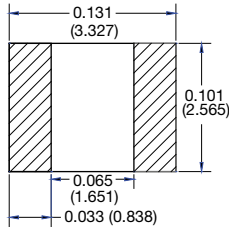

**1206 Land Pattern**

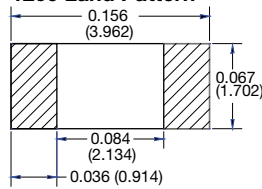

**1505 Land Pattern**

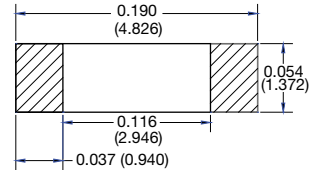

**2010 Land Pattern**

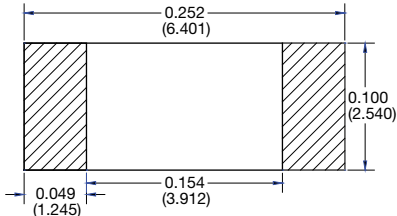

**2208 Land Pattern**

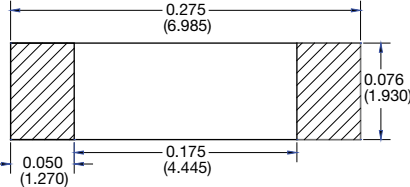

**2512 Land Pattern**

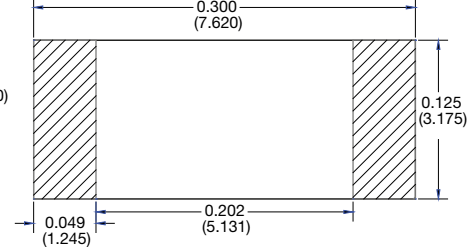



### Thin Film Surface Mount Chip Resistors (PHP, PCAN Series)

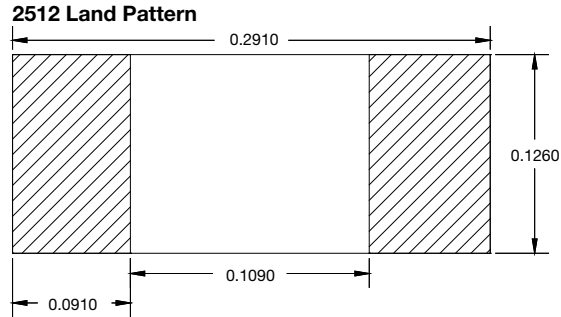
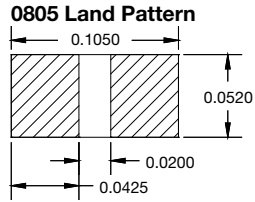
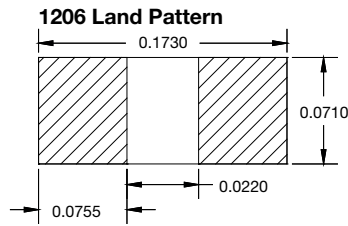
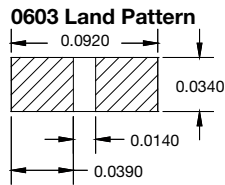

### Thin Film Surface Mount Chip Resistors Long Axis Termination (L Series)

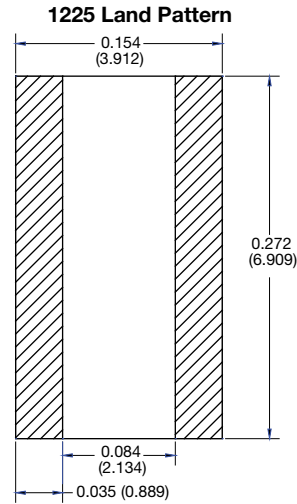
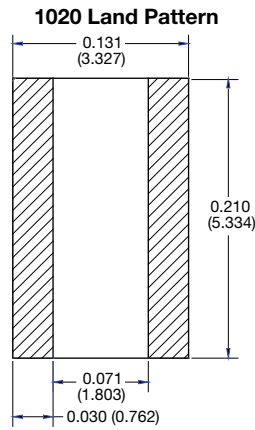
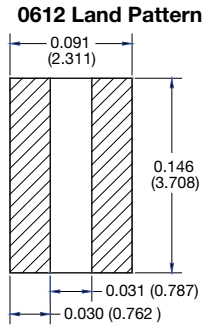
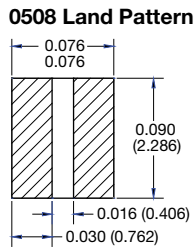



### Surface Mount Networks (MPM, MP3, MP4 Series)

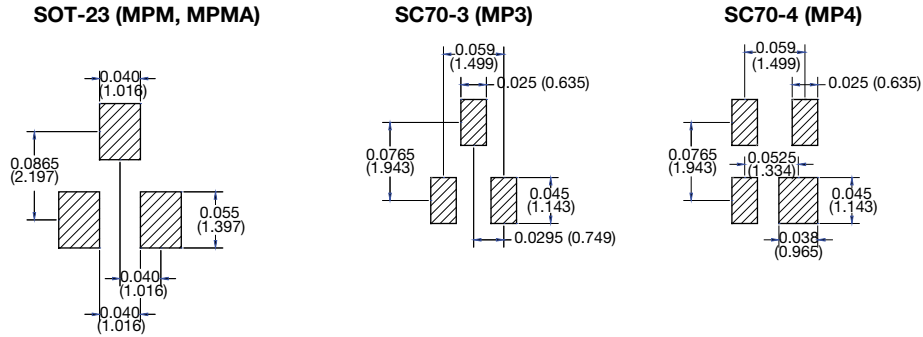

### Surface Mount Networks SOIC Narrow Body 150 mils (ORN, CSO, MOMC, HTRN, AORN, MORN Series)

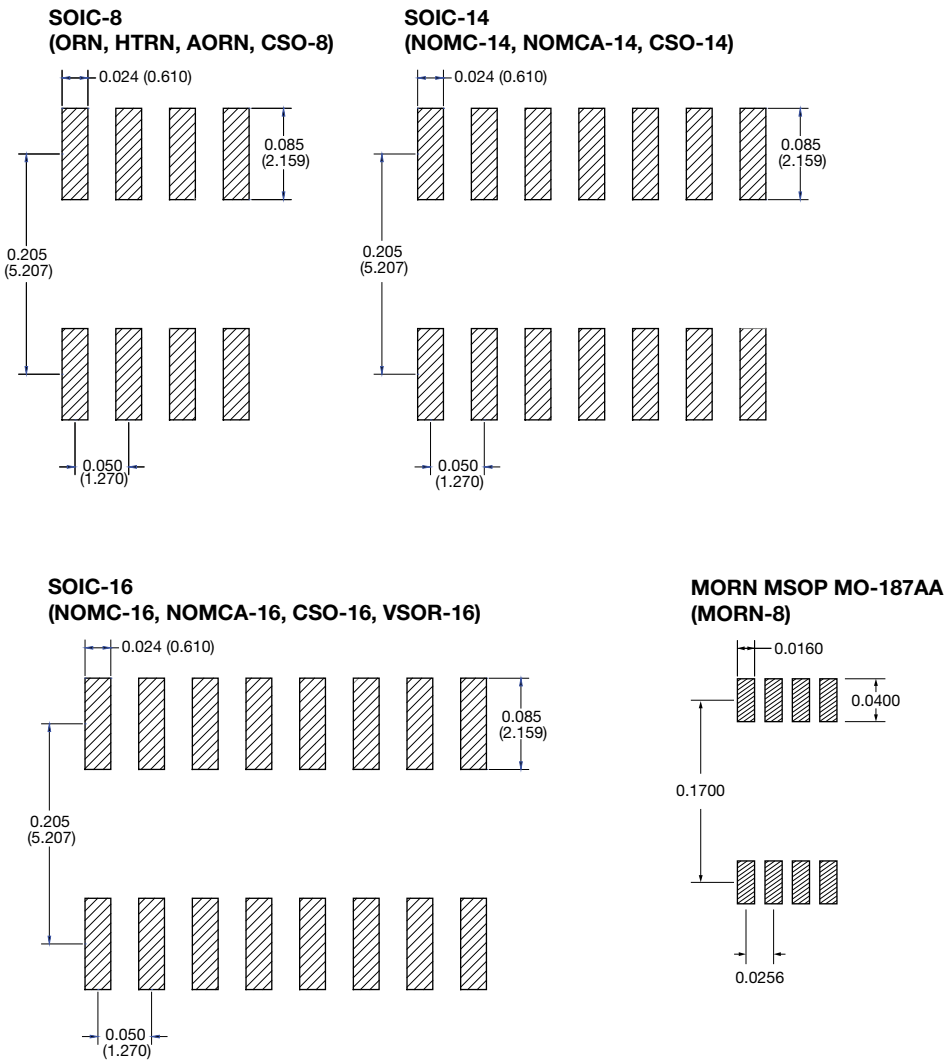



### Surface Mount Networks SOIC Medium Body 220 mils (TOMC Series)

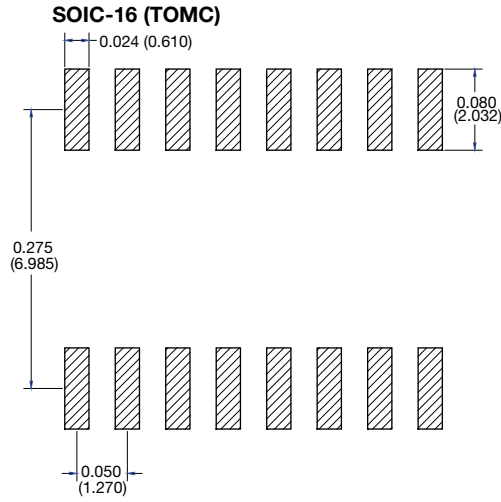

### Surface Mount Networks SOIC Wide Body 300 mils (WOMC Series)

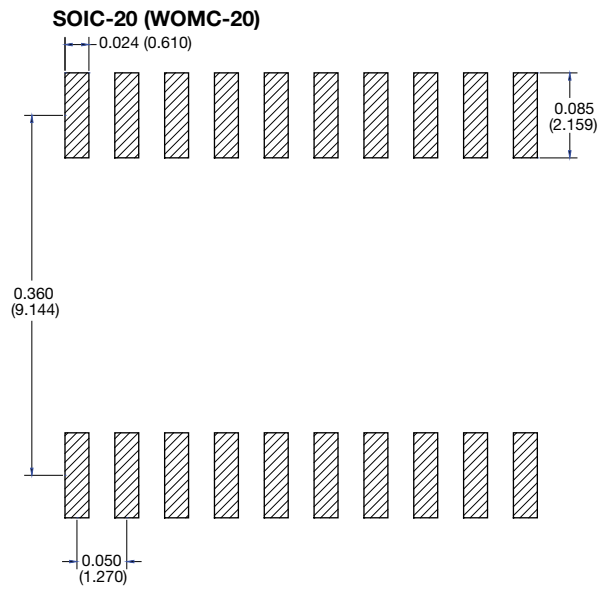
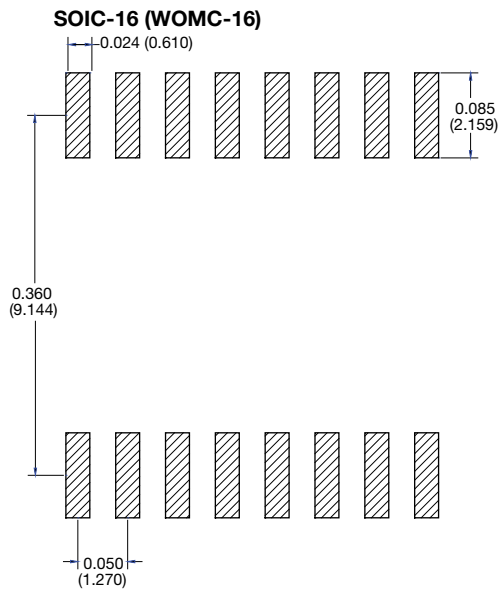



### Surface Mount Networks High Density SSOP, TSOP (VSSR, VTSR Series)

#### SSOP MO-137

##### OSOP-16, VSSR-16

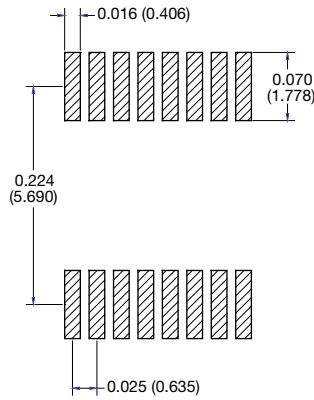

##### OSOP-20, VSSR-20

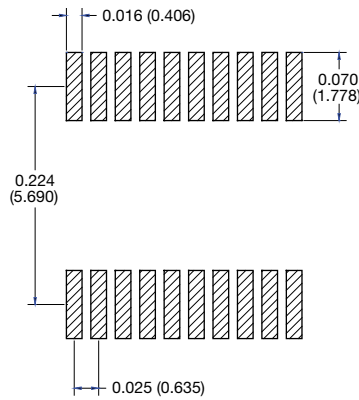

##### OSOP-24, VSSR-24, HD-CSO-24

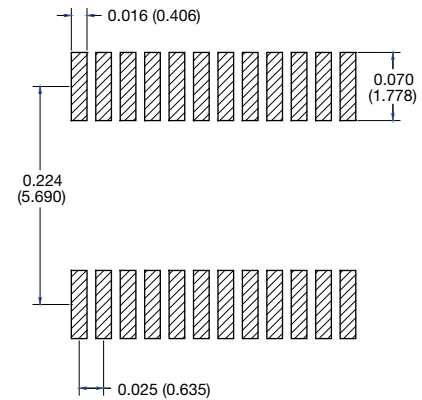

#### TSSOP MO-153

##### VTSR-16

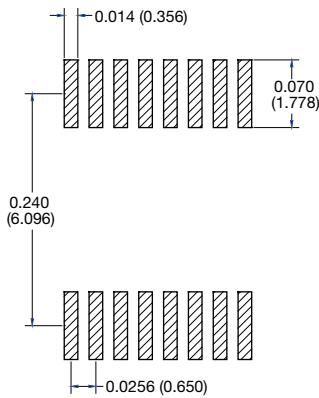

##### VTSR-20

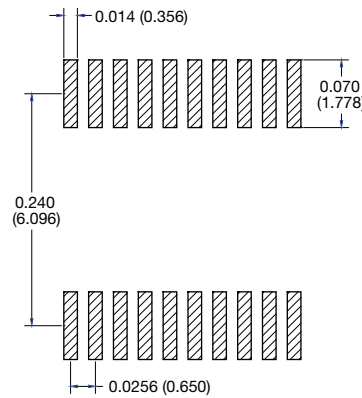

##### VTSR-24

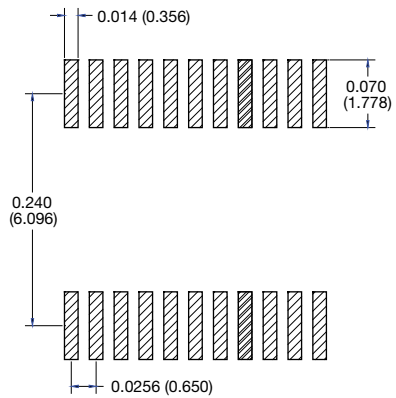

Surface Mount Leadless Networks (LCC Series)

**16 Pin LCC**

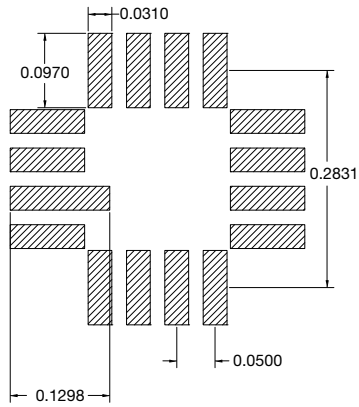

**20 Pin LCC**

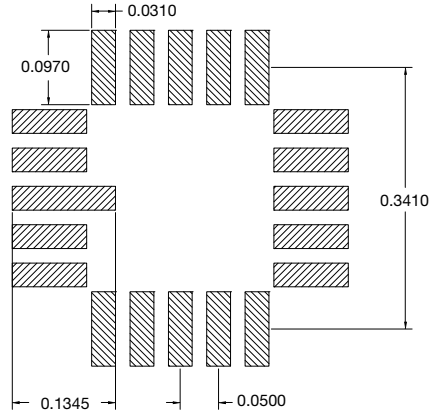

Surface Mount Leadless Networks (MPH Series)

**4 Pin LCC**

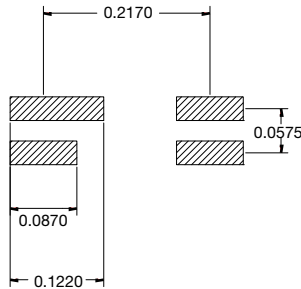

Surface Mount Leadless Packages DUAL/ QUAD Flat No Lead (DFN, QFN Series)

**DFN MLP**

**DFN-8 4 x 5 mm Sq**

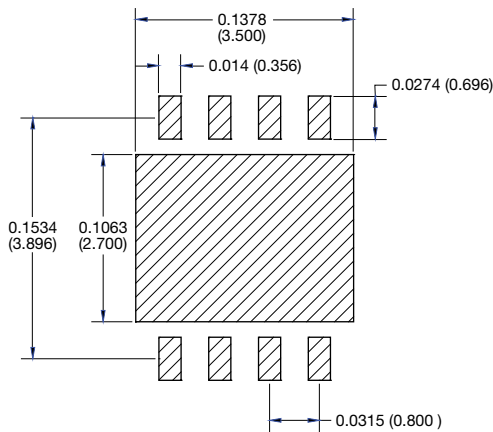

**QFN MLP**

**QFN-20 5 x 5 mm Sq**

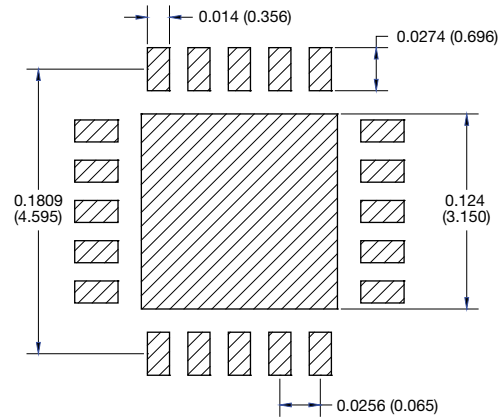



### Surface Mount Leadless Resistor Arrays (PR Series)

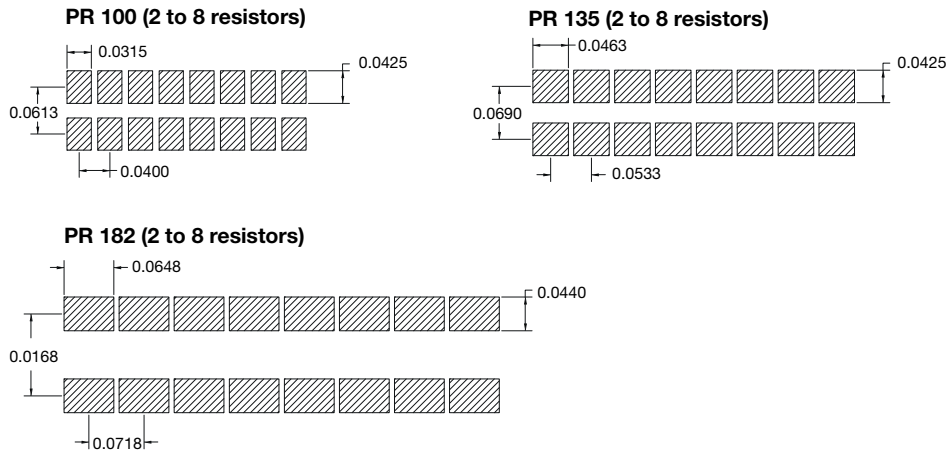

**Note**

- All dimensions in inches (mm)

### Flatpack

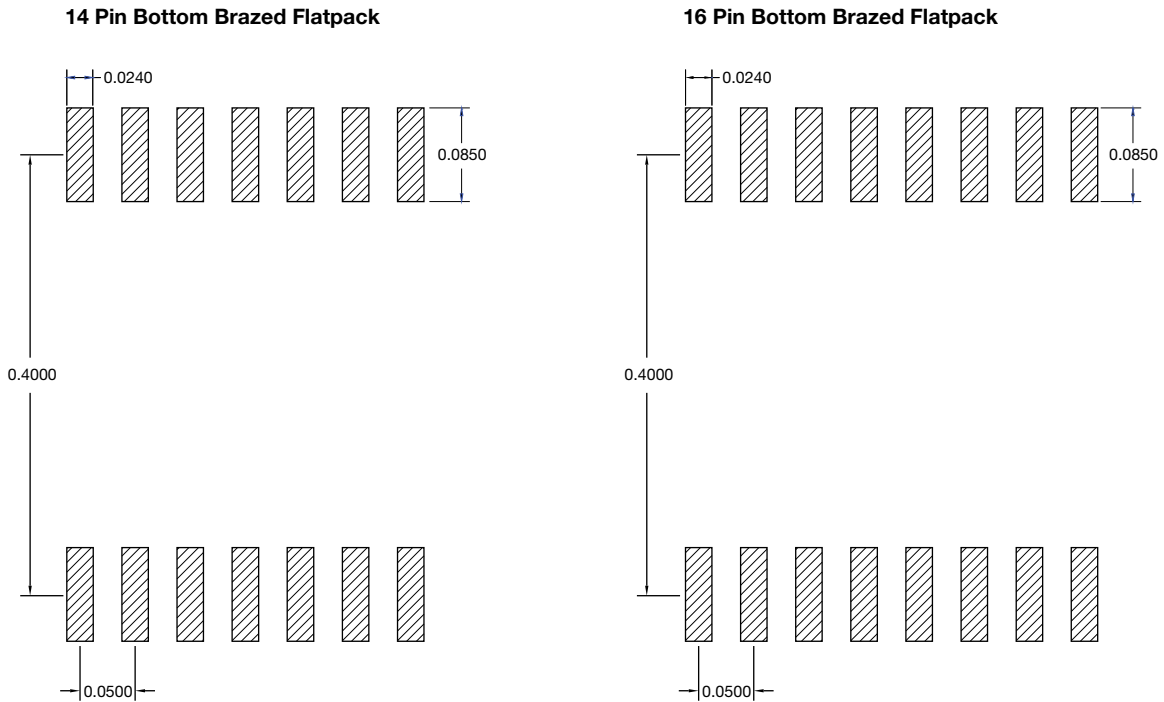



## **Disclaimer**

ALL PRODUCT, PRODUCT SPECIFICATIONS AND DATA ARE SUBJECT TO CHANGE WITHOUT NOTICE TO IMPROVE RELIABILITY, FUNCTION OR DESIGN OR OTHERWISE.

Vishay Intertechnology, Inc., its affiliates, agents, and employees, and all persons acting on its or their behalf (collectively, "Vishay"), disclaim any and all liability for any errors, inaccuracies or incompleteness contained in any datasheet or in any other disclosure relating to any product.

Vishay makes no warranty, representation or guarantee regarding the suitability of the products for any particular purpose or the continuing production of any product. To the maximum extent permitted by applicable law, Vishay disclaims (i) any and all liability arising out of the application or use of any product, (ii) any and all liability, including without limitation special, consequential or incidental damages, and (iii) any and all implied warranties, including warranties of fitness for particular purpose, non-infringement and merchantability.

Statements regarding the suitability of products for certain types of applications are based on Vishay's knowledge of typical requirements that are often placed on Vishay products in generic applications. Such statements are not binding statements about the suitability of products for a particular application. It is the customer's responsibility to validate that a particular product with the properties described in the product specification is suitable for use in a particular application. Parameters provided in datasheets and / or specifications may vary in different applications and performance may vary over time. All operating parameters, including typical parameters, must be validated for each customer application by the customer's technical experts. Product specifications do not expand or otherwise modify Vishay's terms and conditions of purchase, including but not limited to the warranty expressed therein.

Except as expressly indicated in writing, Vishay products are not designed for use in medical, life-saving, or life-sustaining applications or for any other application in which the failure of the Vishay product could result in personal injury or death. Customers using or selling Vishay products not expressly indicated for use in such applications do so at their own risk. Please contact authorized Vishay personnel to obtain written terms and conditions regarding products designed for such applications.

No license, express or implied, by estoppel or otherwise, to any intellectual property rights is granted by this document or by any conduct of Vishay. Product names and markings noted herein may be trademarks of their respective owners.

# Mouser Electronics

Authorized Distributor

Click to View Pricing, Inventory, Delivery & Lifecycle Information:

## Vishay:

[VSSR1603102JUF](#) [VSOR1603103GUF](#) [VSSR1601103JUF](#) [VSSR1603103JUF](#) [VSSR2001472JUF](#)  
[VSSR1601472GTF](#) [VSSR2401472GTF](#) [VSSR1601103JTF](#) [VSSR1603103JTF](#) [VTSR2001102GUF](#)  
[VSOR1601472JTF](#) [VSOR1603102GTF](#) [VSSR2001103GTF](#) [VSSR1603100JTF](#) [VSSR1601472JUF](#)  
[VSSR1603330JTF](#) [VSSR2003330JTF](#) [VSOR1601472GTF](#) [VTSR2003330GTF](#) [VSSR1603472JTF](#) [VSSR1601101JTF](#)  
[VSSR1603510GTF](#) [VTSR1603330GTF](#) [VSSR1601472JTF](#) [VSOR1603103JTF](#) [VSSR2401103JUF](#)  
[VSOR1603203GTF](#) [VSSR1601102JTF](#) [VSSR1601272JUF](#) [VSSR2401102JTF](#) [VSSR2001472JTF](#) [VSSR2403330JUF](#)  
[VTSR2001102GTF](#) [VSSR2403100JTF](#) [VSSR2401472JTF](#) [VSSR2403103JUF](#) [VSSR1603100GTF](#)  
[VTSR2401472GTF](#) [VSSR1603472JUF](#) [VSSR1603220JTF](#) [VSSR1601222JTF](#) [VSSR2001103GUF](#)  
[VSSR2401102JUF](#) [VTSR2001391GTF](#) [VSSR1601473JTF](#) [VSSR2003101JUF](#) [VSSR2401103JTF](#) [VSSR1601822JTF](#)  
[VTSR2401473GTF](#) [VTSR1601103GUF](#) [VSSR2401103GTF](#) [VSSR2001102GTF](#) [VSSR1601222GTF](#)  
[VSSR2403103JTF](#) [VSOR1603103GTF](#) [VSSR1603330GTF](#) [VSSR1601103GUF](#) [VSOR1603222JTF](#)  
[VSOR1603472JTF](#) [VSOR1603101JTF](#) [VTSR1601103GTF](#) [VSSR1603220JUF](#)