

1 Characteristics

Table 1: Absolute ratings (limiting values)

Symbol	Parameter	Value			Unit
		Min.	Typ.	Max.	
P _{IN}	Input power RF _{IN}		-	20	dBm
V _{ESD}	ESD ratings human body model (JESD22-A114-C), all I/O one at a time while others connected to GND	2000	-		V
	ESD ratings charge device model (JESD22-C101-C)	500	-		
	ESD ratings machine model, all I/O	200	-		
T _{OP}	Operating temperature (JESD22-A115-C), all I/O	-40	-	+105	°C
T _{stg}	Storage temperature range	-55°C		+150	°C

Table 2: Impedances (T_{amb} = 25 °C)

Symbol	Parameter	Value			Unit
		Min.	Typ.	Max.	
Z _{OUT}	Nominal differential output impedance	-	matched	-	Ω
Z _{IN}	Nominal input impedance	-	50	-	Ω

Table 3: RF performances (T_{amb} = 25 °C)

Symbol	Parameter	Value			Unit
		Min.	Typ.	Max.	
f	Frequency range (bandwidth)		2400	2540	MHz
I _L	Insertion loss in bandwidth		1.9		dB
RL	Return loss in bandwidth		12		dB
φ _{imb}	Phase imbalance		6		°
A _{imb}	Amplitude imbalance		0.15		dB
2f ₀	2nd harmonic S ₂₁ attenuation	4880 MHz	44	10	dB
3f ₀	3rd harmonic S ₂₁ attenuation	7320 MHz		20	dB

1.1 On-board measurements

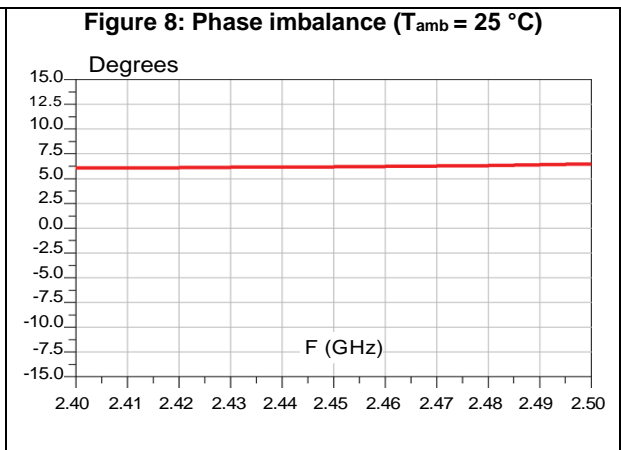
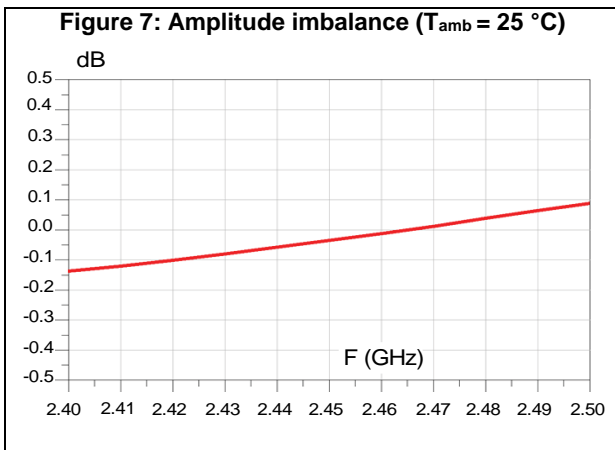
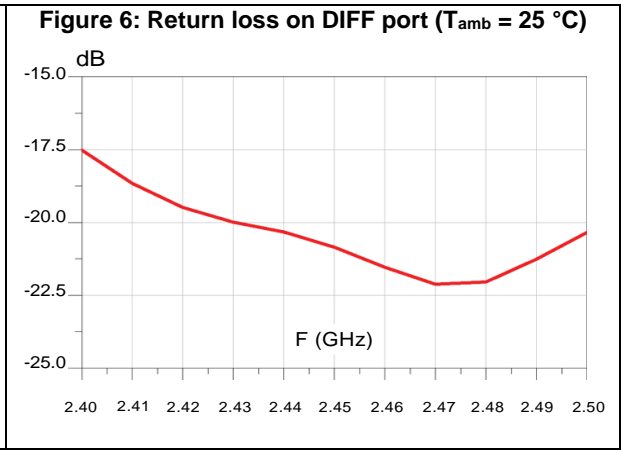
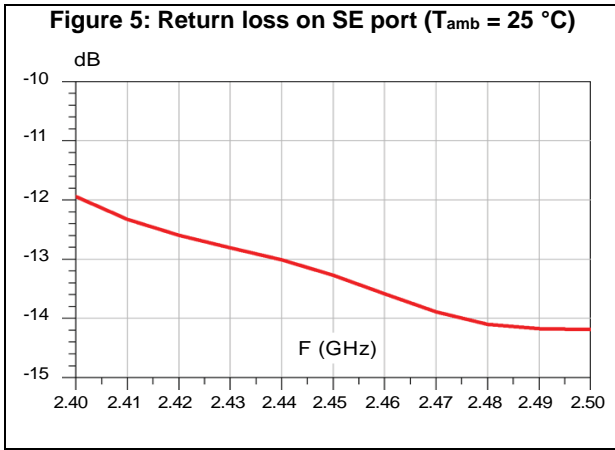
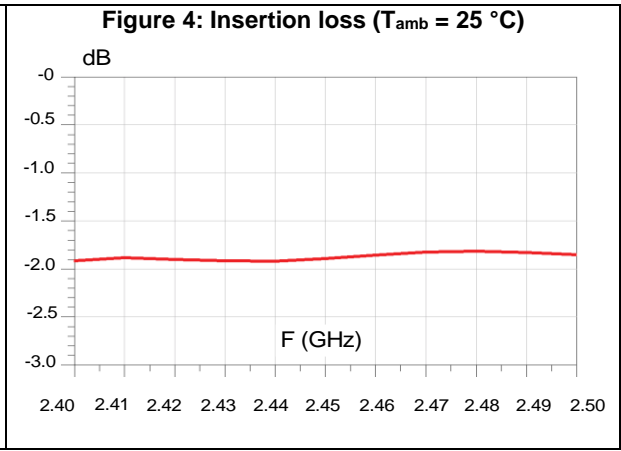
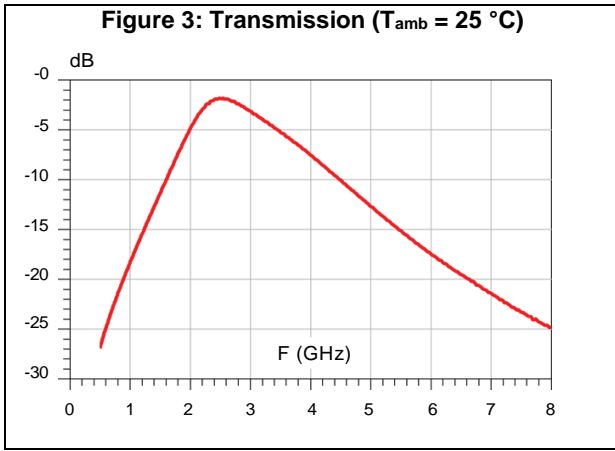

Table 4: Compatibility matrix (nRF51422)

nRF51422 IC revision	Packet/variant	Build code
1	CEAA	A0A
2	CEAA	Bx0
3	CDAB	Ax0
	CEAA	Cx0
	CFAC	Ax0

Table 5: Compatibility matrix (nRF51822)

nRF51822 IC revision	Packet/variant	Build code
1	CEAA	BA
	CEAA	B0
2	CEAA	CA0
	CEAA	DA0
	CEAA	Dx0
3	CDAB	Ax0
	CEAA	Ex0
	CFAC	Ax0

2 Package information

In order to meet environmental requirements, ST offers these devices in different grades of ECOPACK® packages, depending on their level of environmental compliance. ECOPACK® specifications, grade definitions and product status are available at: www.st.com. ECOPACK® is an ST trademark.

- Epoxy meets UL94, V0
- Lead-free package

2.1 Flip-Chip 5 bumps package information

Figure 9: Flip-Chip 5 bumps package outline

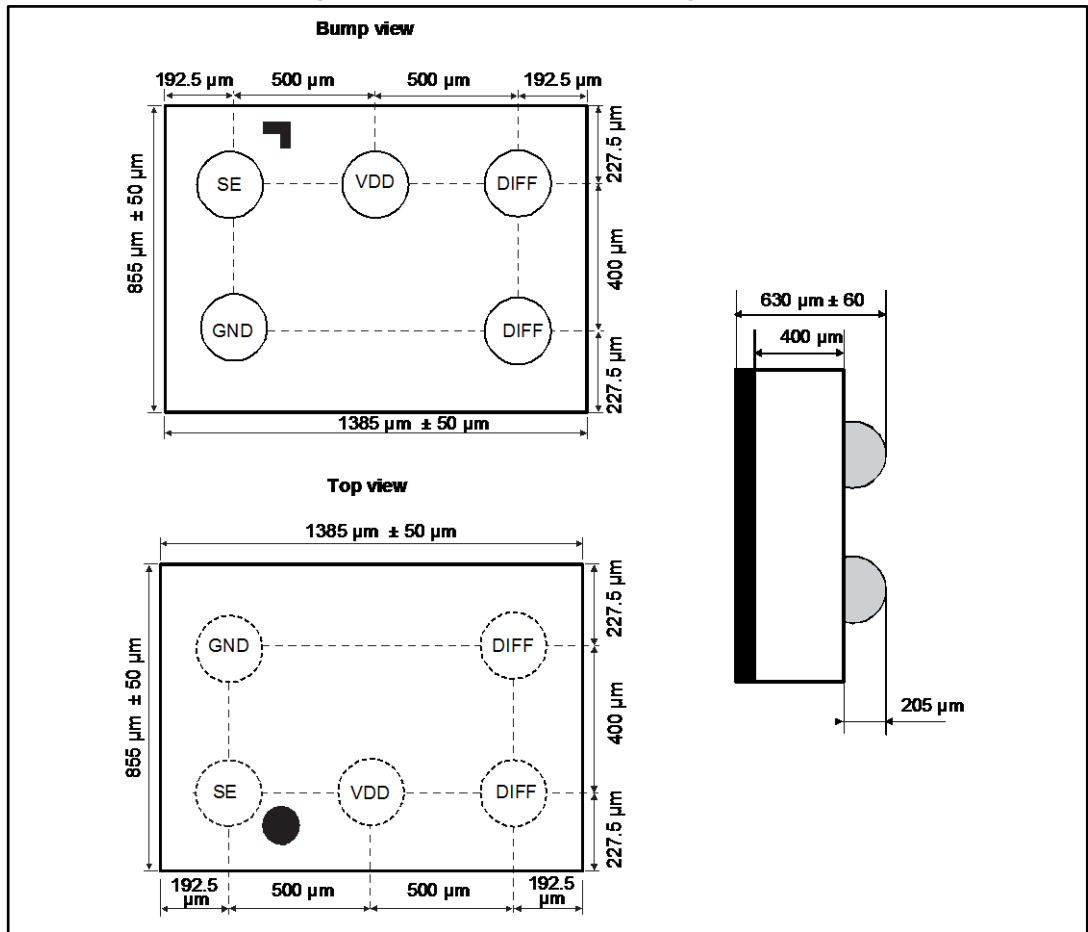

Figure 10: Recommended land pattern

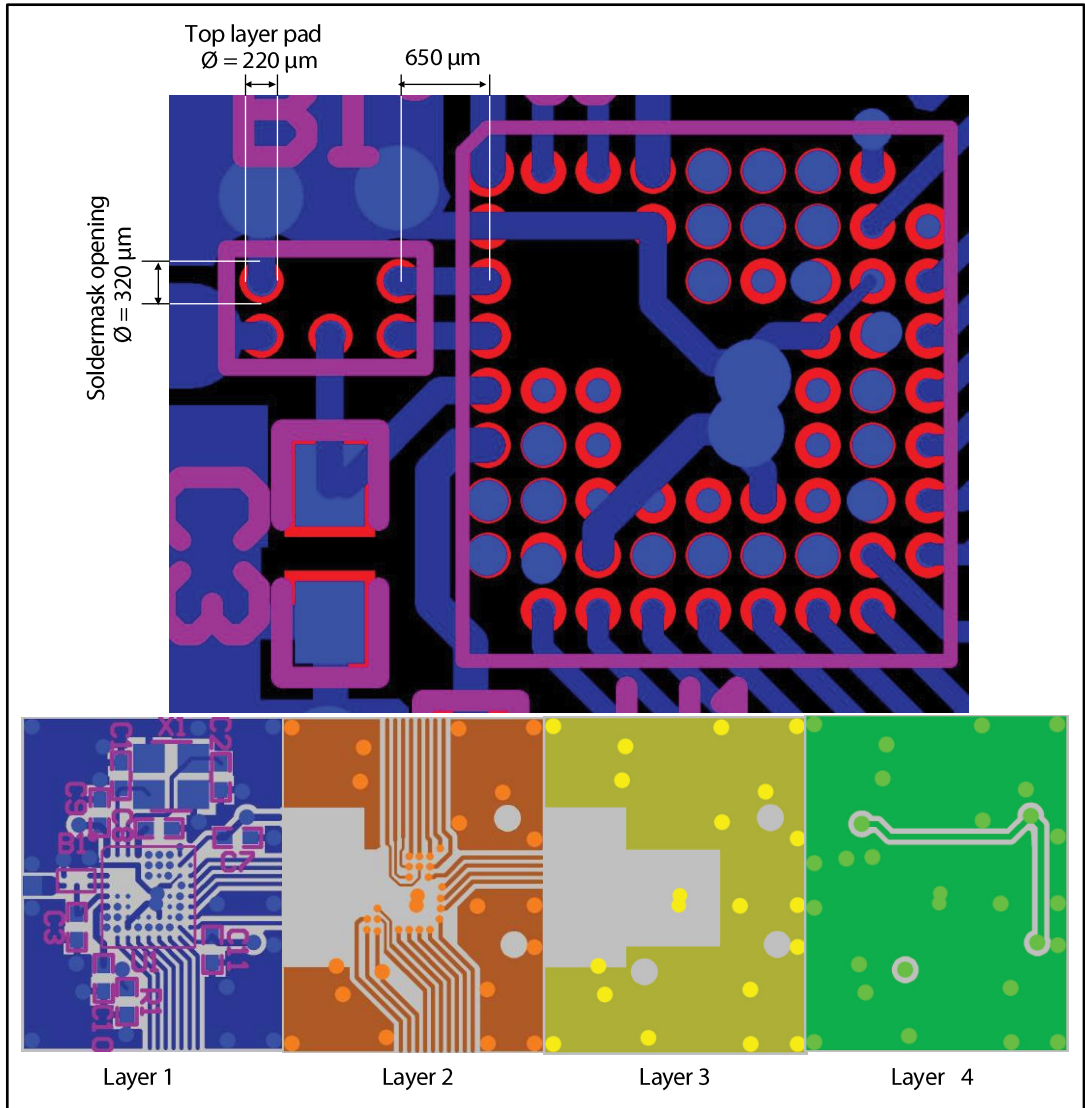
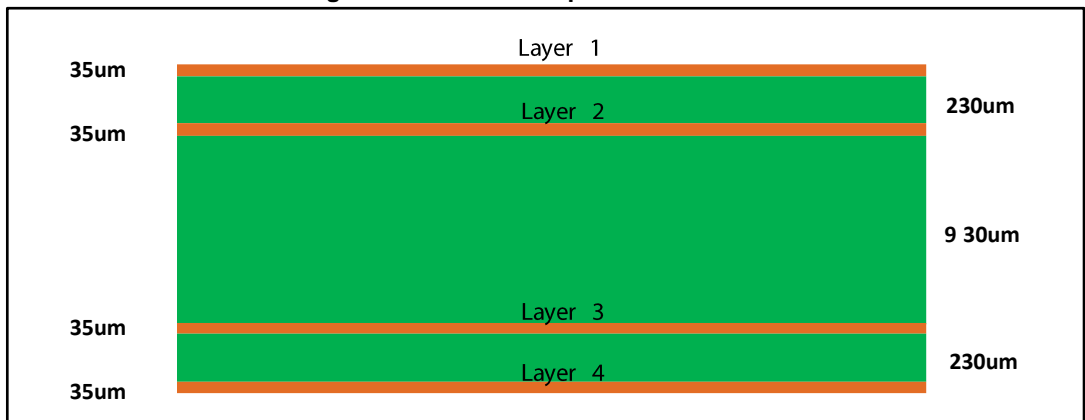

Figure 11: PCB stack-up recommendation



2.2 Flip-chip 5 bumps packing information

Figure 12: Marking

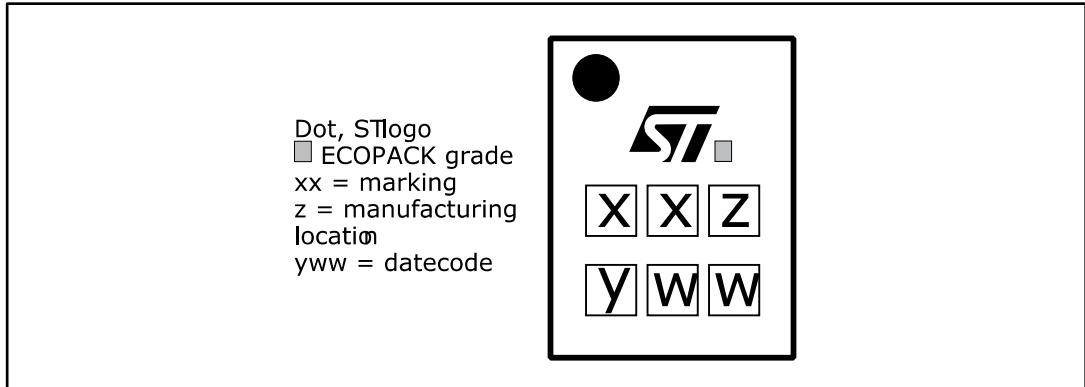
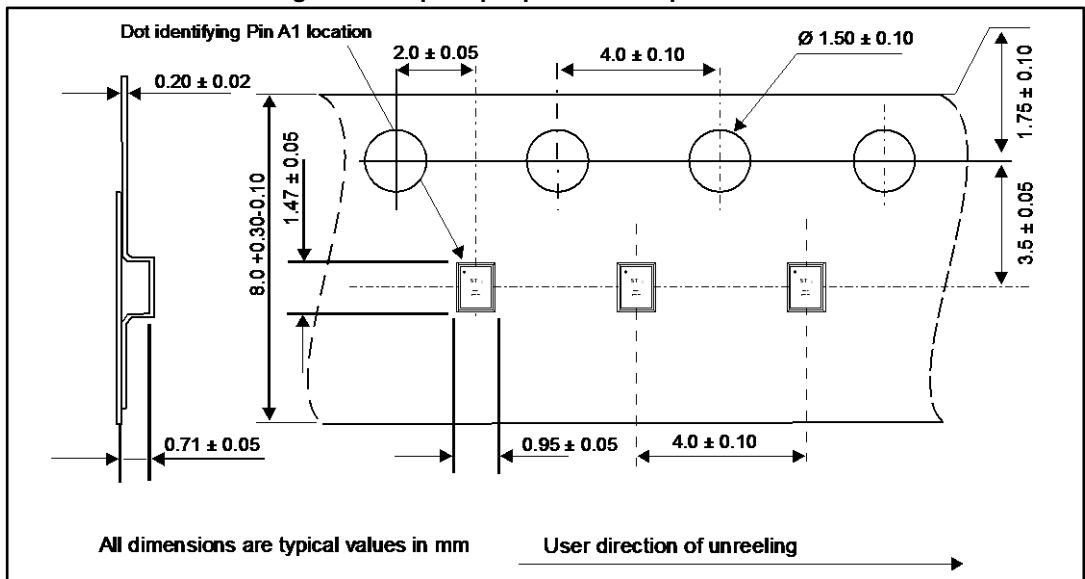

Figure 13: Flip Chip tape and reel specifications



More packing information is available in the application note:

- AN2348 Flip-Chip: “Package description and recommendations for use”
- AN4315: “BAL-NRF02D3 matched balun with integrated harmonics filter for Nordic Semiconductor ultralow power transceivers”

Figure 14: Footprint - 3 mils stencil -non solder mask defined

Copper pad diameter:
 220 μm recommended
 180 μm minimum
 260 μm maximum

Solder mask opening:
 320 μm recommended
 300 μm minimum
 340 μm maximum

Solder stencil opening:
 220 μm recommended

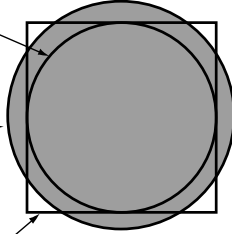

Figure 15: Footprint - 3 mils stencil - solder mask defined

Solder mask opening:
 220 μm recommended
 180 μm minimum
 260 μm maximum

Copper pad diameter:
 320 μm recommended
 300 μm minimum

Solder stencil opening:
 220 μm recommended

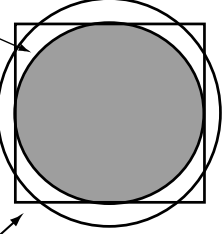

Figure 16: Footprint - 5 mils stencil -non solder mask defined

Copper pad diameter:
 220 μm recommended
 180 μm minimum
 260 μm maximum

Solder mask opening:
 320 μm recommended
 300 μm minimum
 340 μm maximum

Solder stencil opening:
 330 μm recommended*

*depending on paste, it can go down to 270 μm

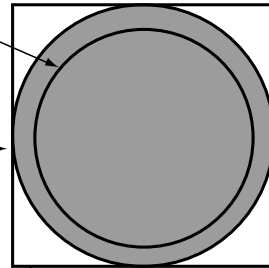

Figure 17: Footprint - 5 mils stencil - solder mask defined

Solder mask opening:
 220 μm recommended
 180 μm minimum
 260 μm maximum

Copper pad diameter:
 320 μm recommended
 300 μm minimum

Solder stencil opening:
 330 μm recommended*

*depending on paste, it can go down to 270 μm

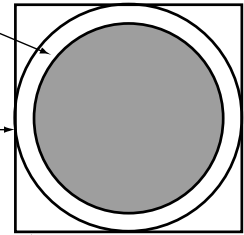

3 Ordering information

Table 6: Ordering information

Order code	Marking	Package	Weight	Base qty.	Delivery mode
BAL-NRF02D3	SK	Flip-Chip 5 bumps	1.44 mg	5000	Tape and reel

4 Revision history

Table 7: Document revision history

Date	Revision	Changes
02-Jul-2013	1	Initial release.
30-Aug-2013	2	Updated <i>Table 1</i> .
13-Oct-2014	3	Updated <i>Figure 9</i> .
25-Mar-2015	4	Updated cover page, added <i>Table 4</i> and <i>Table 5</i> .
15-Jun-2015	5	Updated <i>Table 1</i> .
07-Dec-2016	6	Updated <i>Table 1</i> : " <i>Absolute ratings (limiting values)</i> ".
02-Aug-2017	7	Updated Section 3: "Ordering information".
14-Nov-2017	8	Updated Section "Benefits" .

IMPORTANT NOTICE – PLEASE READ CAREFULLY

STMicroelectronics NV and its subsidiaries ("ST") reserve the right to make changes, corrections, enhancements, modifications, and improvements to ST products and/or to this document at any time without notice. Purchasers should obtain the latest relevant information on ST products before placing orders. ST products are sold pursuant to ST's terms and conditions of sale in place at the time of order acknowledgement.

Purchasers are solely responsible for the choice, selection, and use of ST products and ST assumes no liability for application assistance or the design of Purchasers' products.

No license, express or implied, to any intellectual property right is granted by ST herein.

Resale of ST products with provisions different from the information set forth herein shall void any warranty granted by ST for such product.

ST and the ST logo are trademarks of ST. All other product or service names are the property of their respective owners.

Information in this document supersedes and replaces information previously supplied in any prior versions of this document.

© 2017 STMicroelectronics – All rights reserved

Mouser Electronics

Authorized Distributor

Click to View Pricing, Inventory, Delivery & Lifecycle Information:

[STMicroelectronics:](#)

[BAL-NRF02D3](#)