

Table of Contents

Table of Contents

	Features	1
	Applications	1
	Description	1
	Table of Contents	2
1	Block Diagram	3
2	Pin Configuration and Functionality	4
2.1	Pin Configuration	4
2.2	Pin Functionality	4
3	Functional Description	6
3.1	Introduction	6
3.2	Supply	6
3.3	Protection Features	7
3.3.1	Undervoltage Lockout (UVLO)	7
3.3.2	Active Shut-Down	7
3.3.3	Short Circuit Clamping	7
3.4	Non-Inverting and Inverting Inputs	7
3.5	Driver Outputs	8
4	Electrical Parameters	9
4.1	Absolute Maximum Ratings	9
4.2	Operating Parameters	10
4.3	Electrical Characteristics	10
4.3.1	Voltage Supply	10
4.3.2	Logic Input	11
4.3.3	Gate Driver	12
4.3.4	Short Circuit Clamping	13
4.3.5	Dynamic Characteristics	13
4.3.6	Active Shut Down	14
5	Package Outline	15
6	Application Notes	16
6.1	Reference Layout for Thermal Data	16
6.2	Printed Circuit Board Guidelines	16
	Revision History	16
	Trademarks	17

Block Diagram

1 Block Diagram

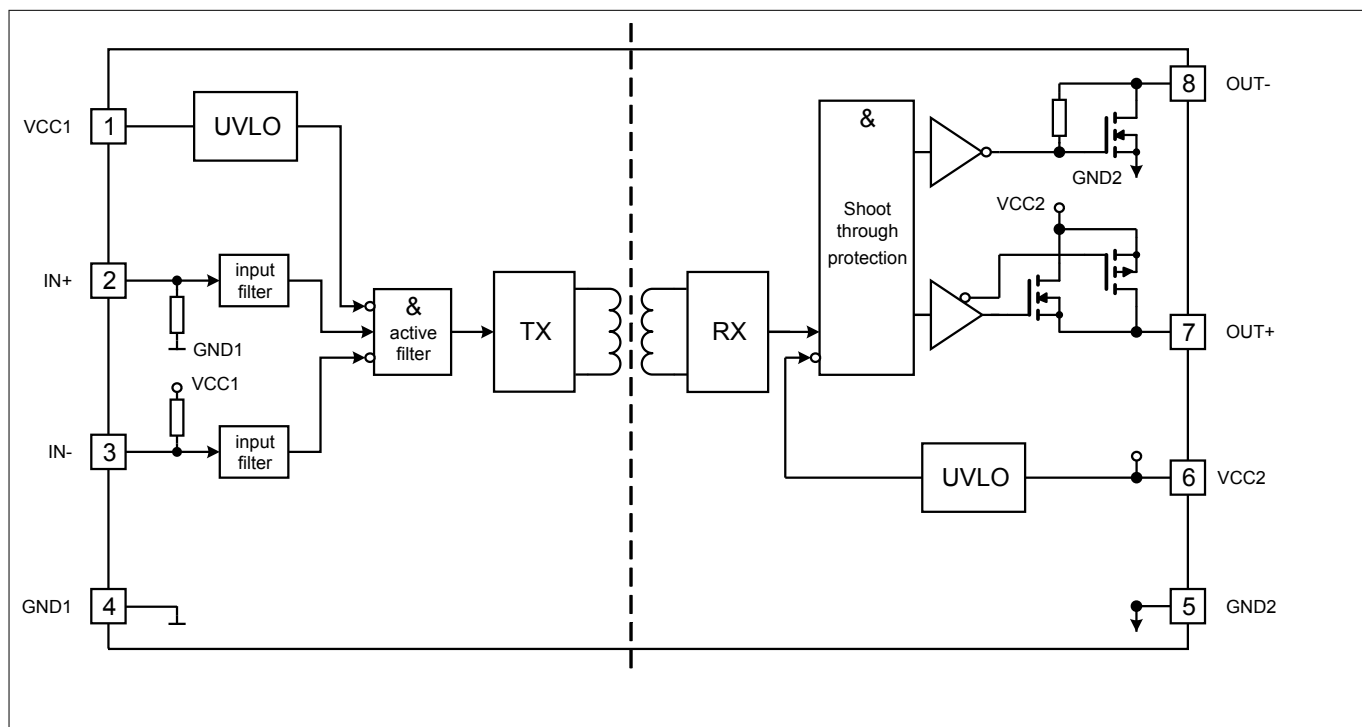

Figure 1 Block Diagram

Pin Configuration and Functionality

2 Pin Configuration and Functionality

2.1 Pin Configuration

Table 1 Pin Configuration

Pin No.	Name	Function
1	VCC1	Positive logic supply
2	IN+	Non-inverted driver input (active high)
3	IN-	Inverted driver input (active low)
4	GND1	Logic ground
5	GND2	Power ground
6	VCC2	Positive power supply output side
7	OUT+	Driver source output
8	OUT-	Driver sink output

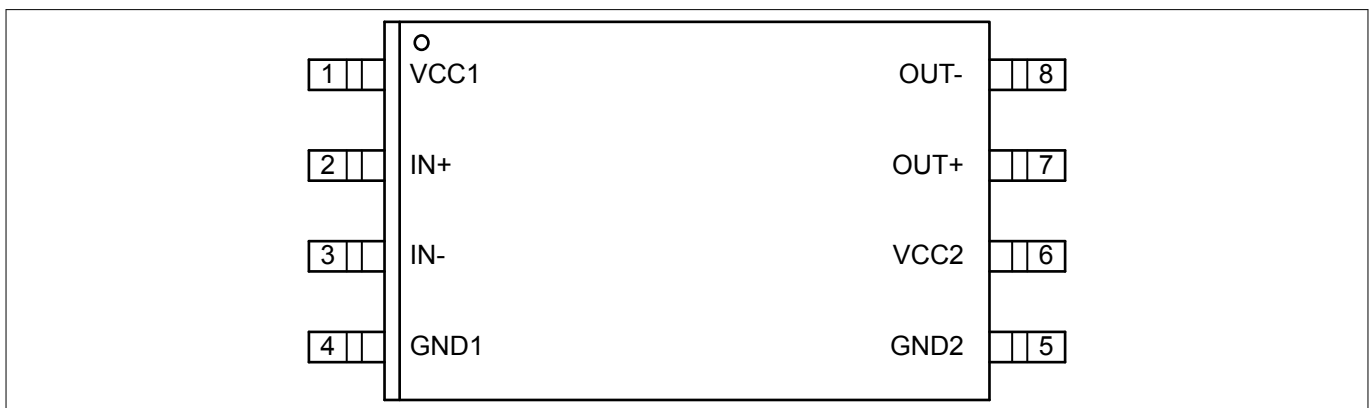

Figure 2 PG-DSO-8-59 (top view)

2.2 Pin Functionality

VCC1

Logic input supply voltage of 3.3 V up to 15 V wide operating range.

IN+ Non Inverting Driver Input

IN+ non-inverted control signal for driver output if IN- is set to low. (Output sourcing active at IN+ = high and IN- = low)

Due to internal filtering a minimum pulse width is defined to ensure robustness against noise at IN+. An internal weak pull-down-resistor favors off-state.

IN- Inverting Driver Input

IN- inverted control signal for driver output if IN+ is set to high. (Output sourcing active at IN- = low and IN+ = high)

Pin Configuration and Functionality

Due to internal filtering a minimum pulse width is defined to ensure robustness against noise at IN-. An internal weak pull-up-resistor favors off-state.

GND1

Ground connection of input circuit.

GND2 Reference Ground

Reference ground of the output driving circuit.

In case of a bipolar supply (positive and negative voltage referred to IGBT emitter) this pin is connected to the negative supply voltage.

VCC2

Positive power supply pin of output driving circuit. A proper blocking capacitor has to be placed close to this supply pin.

OUT+ Driver Source Output

Driver source output pin to turn on external IGBT. During on-state the driving output is switched to VCC2. Switching of this output is controlled by IN+ and IN-. This output will also be turned off at an UVLO event.

During turn off the OUT+ terminal is able to sink approx. 100 mA. In case of an unconnected OUT- the complete gate charge is discharged through this channel resulting in a slow turn off.

OUT- Driver Sink Output

Driver sink output pin to turn off external IGBT. During off-state the driving output is switched to GND2.

Switching of this output is controlled by IN+ and IN-. In case of UVLO an active shut down keeps the output voltage at a low level.

Functional Description

3 Functional Description

3.1 Introduction

The 1EDIxxI12AH and 1EDIxxH12AH are general purpose IGBT gate drivers. Basic control and protection features support fast and easy design of highly reliable systems.

The integrated galvanic isolation between control input logic and driving output stage grants additional safety. Its wide input voltage supply range supports the direct connection of various signal sources like DSPs and microcontrollers.

The separated rail-to-rail driver outputs simplify gate resistor selection, save an external high current bypass diode and enhance dV/dt control.

3.2 Supply

The driver can operate over a wide supply voltage range, either unipolar or bipolar.

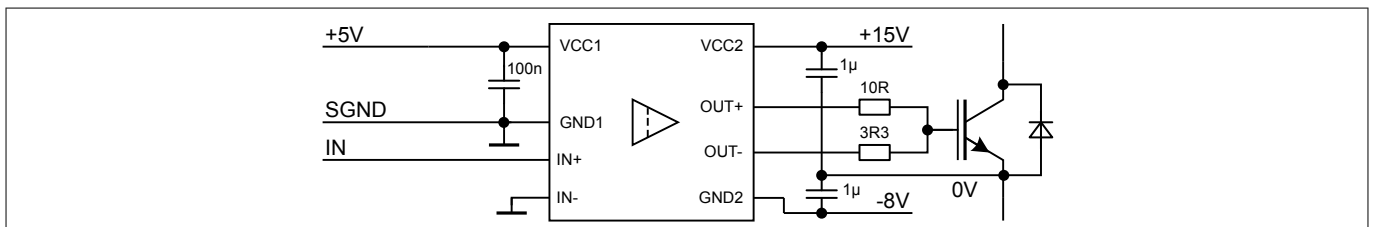

Figure 3 Application Example Bipolar Supply

With bipolar supply the driver is typically operated with a positive voltage of 15 V at VCC2 and a negative voltage of -8 V at GND2 relative to the emitter of the IGBT. Negative supply can help to prevent a dynamic turn on due to the additional charge which is generated from IGBT's input capacitance.

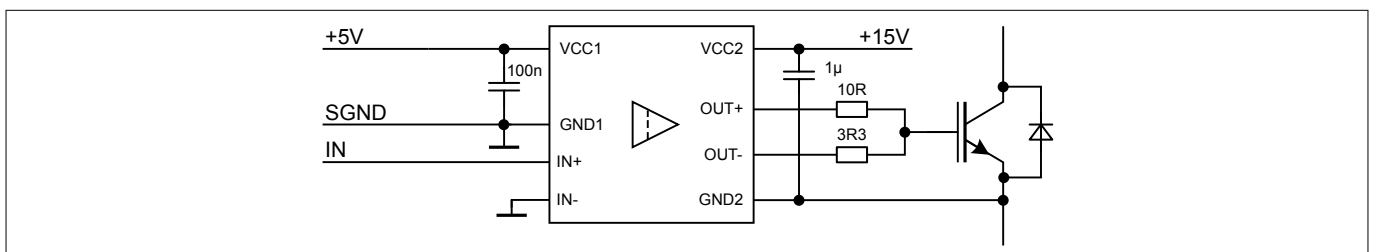

Figure 4 Application Example Unipolar Supply

For unipolar supply configuration the driver is typically supplied with a positive voltage of 15 V at VCC2. In this case, careful evaluation for turn off gate resistor selection is recommended to avoid dynamic turn on.

Functional Description

3.3 Protection Features

3.3.1 Undervoltage Lockout (UVLO)

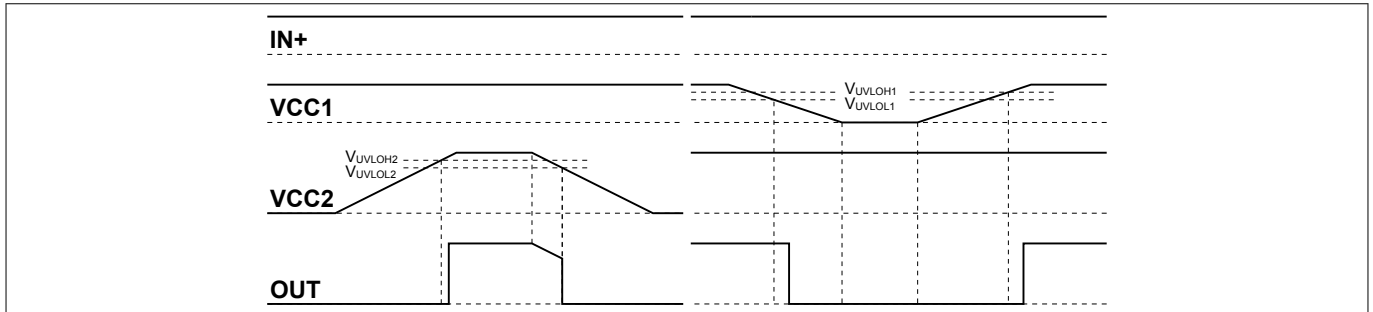

Figure 5 UVLO Behavior

To ensure correct switching of IGBTs the device is equipped with an undervoltage lockout for input and output independently. Operation starts only after both VCC levels have increased beyond the respective V_{UVLOH} levels.

If the power supply voltage V_{VCC1} of the input chip drops below V_{UVLOL1} a turn-off signal is sent to the output chip before power-down. The IGBT is switched off and the signals at IN+ and IN- are ignored until V_{VCC1} reaches the power-up voltage V_{UVLOH1} again.

If the power supply voltage V_{VCC2} of the output chip goes down below V_{UVLOL2} the IGBT is switched off and signals from the input chip are ignored until V_{VCC2} reaches the power-up voltage V_{UVLOH2} again.

Note: V_{VCC2} is always referred to GND2 and does not differentiate between unipolar or bipolar supply.

3.3.2 Active Shut-Down

The active shut-down feature ensures a safe IGBT off-state in case the output chip is not connected to the power supply or an undervoltage lockout is in effect. The IGBT gate is clamped at OUT- to GND2.

3.3.3 Short Circuit Clamping

During short circuit the IGBT's gate voltage tends to rise because of the feedback via the Miller capacitance. An additional protection circuit connected to OUT+ limits this voltage to a value slightly higher than the supply voltage. A maximum current of 500 mA may be fed back to the supply through this path for 10 μ s. If higher currents are expected or tighter clamping is desired external Schottky diodes may be added.

3.4 Non-Inverting and Inverting Inputs

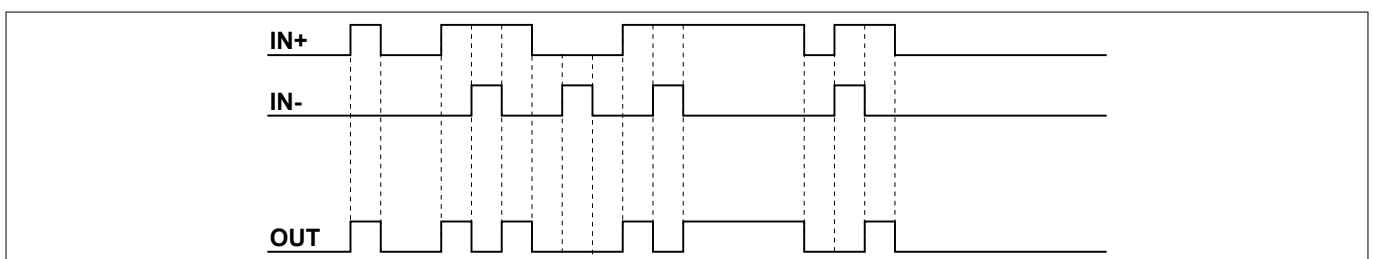

Figure 6 Typical Switching Behavior

Functional Description

There are two possible input modes to control the IGBT. At non-inverting mode IN+ controls the driver output while IN- is set to low. At inverting mode IN- controls the driver output while IN+ is set to high. A minimum input pulse width is defined to filter occasional glitches.

3.5 Driver Outputs

The output driver section uses MOSFETs to provide a rail-to-rail output. This feature permits that tight control of gate voltage during on-state and short circuit can be maintained as long as the driver's supply is stable. Due to the low internal voltage drop, switching behavior of the IGBT is predominantly governed by the gate resistor. Furthermore, it reduces the power to be dissipated by the driver.

Electrical Parameters

4 Electrical Parameters

4.1 Absolute Maximum Ratings

Note: Absolute maximum ratings are defined as ratings, which when being exceeded may lead to destruction of the integrated circuit. Unless otherwise noted all parameters refer to GND1.

Table 2 Absolute Maximum Ratings

Parameter	Symbol	Values		Unit	Note / Test Condition
		Min.	Max.		
Power supply output side	V _{VCC2}	-0.3	40	V	¹⁾
Gate driver output	V _{OUT}	V _{GND2} -0.3	V _{VCC2} +0.3	V	¹⁾
Positive power supply input side	V _{VCC1}	-0.3	18.0	V	–
Logic input voltages (IN+,IN-)	V _{LogicIN}	-0.3	18.0	V	–
Input to output isolation voltage (GND2)	V _{GND2}	-1200	1200	V	GND2 - GND1
Junction temperature	T _J	-40	150	°C	–
Storage temperature	T _S	-55	150	°C	–
Power dissipation (Input side)	P _{D, IN}	–	25	mW	²⁾ @T _A = 25°C
Power dissipation (Output side)	P _{D, OUT}	–	400	mW	²⁾ @T _A = 25°C
Thermal resistance (Input side)	R _{THJA, IN}	–	145	K/W	²⁾ @T _A = 85°C
Thermal resistance (Output side)	R _{THJA, OUT}	–	165	K/W	²⁾ @T _A = 85°C
ESD capability	V _{ESD, HBM}	–	2	kV	Human body model ³⁾
	V _{ESD, CDM}	–	1	kV	Charged device model ⁴⁾

¹ With respect to GND2.

² See **Figure 10** for reference layouts for these thermal data. Thermal performance may change significantly with layout and heat dissipation of components in close proximity.

³ According to EIA/JESD22-A114-C (discharging a 100 pF capacitor through a 1.5 kΩ series resistor).

⁴ According to EIA/JESD22-C101 (specified waveform characteristics)

Electrical Parameters

4.2 Operating Parameters

Note: Within the operating range the IC operates as described in the functional description. Unless otherwise noted all parameters refer to GND1.

Table 3 Operating Parameters

Parameter	Symbol	Values		Unit	Note / Test Condition
		Min.	Max.		
Power supply output side	V _{VCC2}	13	35	V	5)
Power supply input side	V _{VCC1}	3.1	17	V	–
Logic input voltages (IN+,IN-)	V _{LogicIN}	-0.3	17	V	–
Switching frequency	f _{sw}	–	1.0	MHz	6)7)
Ambient temperature	T _A	-40	125	°C	–
Thermal coefficient, junction-top	Ψ _{th,jt}	–	4.8	K/W	7) at T _A = 85°C
Common mode transient immunity (CMTI)	dV _{ISO} /dt	–	100	kV/μs	7) at 1000 V

4.3 Electrical Characteristics

Note: The electrical characteristics include the spread of values in supply voltages, load and junction temperatures given below. Typical values represent the median values at T_A = 25°C. Unless otherwise noted all voltages are given with respect to their respective GND (GND1 for pins 1 to 3, GND2 for pins 6 to 8).

4.3.1 Voltage Supply

Table 4 Voltage Supply

Parameter	Symbol	Values			Unit	Note or Test Condition
		Min.	Typ.	Max.		
UVLO threshold input chip	V _{UVLOH1}	–	2.85	3.1	V	–
	V _{UVLOL1}	2.55	2.75	–	V	–
UVLO hysteresis input chip (V _{UVLOH1} - V _{UVLOL1})	V _{HYS1}	0.09	0.1	–	V	–
UVLO threshold output chip (IGBT supply)	V _{UVLOH2}	–	12.0	12.7	V	8)
	V _{UVLOL2}	10.5	11.1	–	V	8)

⁵ With respect to GND2.

⁶ do not exceed max. power dissipation

⁷ Parameter is not subject to production test - verified by design/characterization

⁸ With respect to GND2.

Electrical Parameters

Table 4 Voltage Supply (Continued)

Parameter	Symbol	Values			Unit	Note or Test Condition
		Min.	Typ.	Max.		
UVLO hysteresis output chip ($V_{UVLOH2} - V_{UVLOL2}$)	V_{HYS2}	0.7	0.85	–	V	–
Quiescent current input chip	I_{Q1}	–	0.65	1.0	mA	$V_{VCC1} = 5\text{ V}$ IN+ = High, IN- = Low =>OUT = High
Quiescent current output chip	I_{Q2}	–	1.2	2.0	mA	$V_{VCC2} = 15\text{ V}$ IN+ = High, IN- = Low =>OUT = High

4.3.2 Logic Input

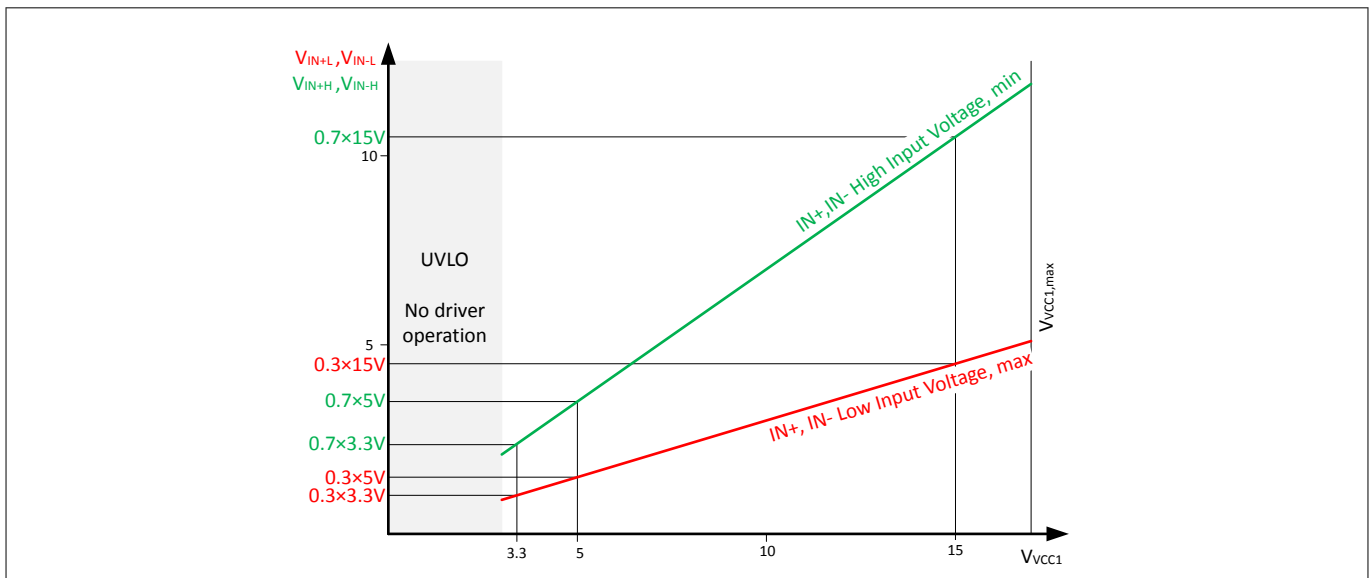

Figure 7 VCC1 scaled input threshold voltage of IN+ and IN-

Beginning from the input undervoltage lockout level, threshold levels for IN+ and IN- are scaled to V_{VCC1} . The high input threshold is 70% of V_{VCC1} and the low input threshold is at 30% of V_{VCC1} .

Table 5 Logic Input

Parameter	Symbol	Values			Unit	Note or Test Condition
		Min.	Typ.	Max.		
IN+,IN- low input voltage	$V_{IN+L},$ V_{IN-L}	–	–	$0.3 \times V_{VCC1}$		⁹⁾ $3.1\text{ V} \leq V_{VCC1} \leq 17\text{ V}$
IN+,IN- high input voltage	$V_{IN+H},$ V_{IN-H}	$0.7 \times V_{VCC1}$	–	–		

⁹ Parameter is not subject to production test - verified by design/characterization

Electrical Parameters

Table 5 Logic Input (Continued)

Parameter	Symbol	Values			Unit	Note or Test Condition
		Min.	Typ.	Max.		
IN+,IN- low input voltage	V_{IN+L} , V_{IN-L}	–	–	1.5	V	$V_{VCC1} = 5.0\text{ V}$
IN+,IN- high input voltage	V_{IN+H} , V_{IN-H}	3.5	–	–	V	
IN- input current	I_{IN-}	–	70	200	μA	$V_{VCC1} = 5.0\text{ V}$, $V_{IN-} = \text{GND1}$
IN+ input current	I_{IN+}	–	70	200	μA	$V_{VCC1} = 5.0\text{ V}$, $V_{IN+} = V_{VCC1}$

4.3.3 Gate Driver

Note: minimum Peak current rating valid over temperature range!

Table 6 Gate Driver

Parameter	Symbol	Values			Unit	Note or Test Condition
		Min.	Typ.	Max.		
High level output peak current (source)	$I_{OUT+,PEAK}$			–	A	¹⁰⁾ IN+ = High, IN- = Low, $V_{VCC2} = 15\text{ V}$
1EDI05I12AH		0.5	1.3			
1EDI20I12AH		2.0	4.0			
1EDI20H12AH		2.0	4.0			
1EDI40I12AH		4.0	7.5			
1EDI60I12AH		6.0	10.0			
1EDI60H12AH		6.0	10.0			
Low level output peak current (sink)	$I_{OUT-,PEAK}$			–	A	¹⁰⁾ IN+ = Low, IN- = Low, $V_{VCC2} = 15\text{ V}$
1EDI05I12AH		0.5	0.9			
1EDI20I12AH		2.0	3.5			
1EDI20H12AH		2.0	3.5			
1EDI40I12AH		4.0	6.8			
1EDI60I12AH		6.0	9.4			
1EDI60H12AH		6.0	9.4			

¹⁰⁾ specified min. output current is forced; voltage across the device $V_{(VCC2 - OUT+)}$ or $V_{(OUT- - GND2)} < V_{VCC2}$.

Electrical Parameters

4.3.4 Short Circuit Clamping

Table 7 Short Circuit Clamping

Parameter	Symbol	Values			Unit	Note or Test Condition
		Min.	Typ.	Max.		
Clamping voltage (OUT+) ($V_{OUT+} - V_{VCC2}$)	V_{CLPout}	-	0.9	1.3	V	¹¹⁾ $IN+ = High, IN- = Low,$ $OUT = High$ $I_{OUT} = 500\text{ mA},$ (pulse test $t_{CLPmax} = 10\ \mu s$)

4.3.5 Dynamic Characteristics

Dynamic characteristics are measured with $V_{VCC1} = 5\text{ V}$ and $V_{VCC2} = 15\text{ V}$.

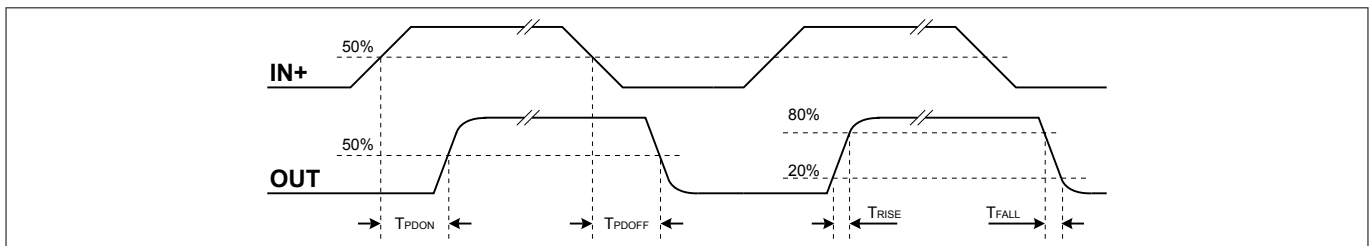

Figure 8 Propagation Delay, Rise and Fall Time

Table 8 Dynamic Characteristics

Parameter	Symbol	Values			Unit	Note or Test Condition
		Min.	Typ.	Max.		
Input IN to output propagation delay ON	T_{PDON}	270	300	330	ns	$C_{LOAD} = 100\text{ pF}$ $V_{IN+} = 50\%,$ $V_{OUT} = 50\% @ 25^\circ C$ 1EDI05I12AH, 1EDI20I12AH, 1EDI40I12AH, 1EDI60I12AH
Input IN to output propagation delay OFF	T_{PDOFF}	270	300	330	ns	
Input IN to output propagation delay distortion ($T_{PDOFF} - T_{PDON}$)	T_{PDISTO}	-30	5	40	ns	
Input pulse suppression time IN+, IN-	$T_{MININ+},$ T_{MININ-}	230	240	-	ns	

¹¹ With respect to GND2.

Electrical Parameters

Table 8 Dynamic Characteristics (Continued)

Parameter	Symbol	Values			Unit	Note or Test Condition
		Min.	Typ.	Max.		
Input IN to output propagation delay ON	T _{PDON}	95	120	142	ns	C _{LOAD} = 100 pF V _{IN+} = 50%, V _{OUT} =50% @25°C 1EDI20H12AH, 1EDI60H12AH
Input IN to output propagation delay OFF	T _{PD_{OFF}}	105	125	150	ns	
Input IN to output propagation delay distortion (T _{PD_{OFF}} - T _{PDON})	T _{PDISTO}	-35	-5	25	ns	
Input Pulse Suppression time IN+, IN-	T _{MININ+} , T _{MININ-}	30	40	-	ns	
Input IN to output propagation delay ON variation due to temp	T _{PDONt}	-	-	14	ns	¹²⁾ C _{LOAD} = 100 pF V _{IN+} = 50%, V _{OUT} =50%
Input IN to output propagation delay OFF variation due to temp	T _{PDONt}	-	-	14	ns	
Input IN to output propagation delay distortion variation due to temp (T _{PD_{OFF}} -T _{PDON})	T _{PDISTOt}	-	-	8	ns	
Rise time	T _{RISE}	5	10	20	ns	C _{LOAD} = 1 nF
Fall time	T _{FALL}	4	9	19	ns	V _L 20%, V _H 80%

4.3.6 Active Shut Down

Table 9 Active Shut Down

Parameter	Symbol	Values			Unit	Note or Test Condition
		Min.	Typ.	Max.		
Active shut down voltage	V _{ACTSD}	-	2.0	2.3	V	¹³⁾ I _{OUT-} /I _{OUT-,PEAK} =0.1, V _{CC2} open

¹² Parameter is not subject to production test - verified by design/characterization

¹³ With respect to GND2.

Package Outline

5 Package Outline

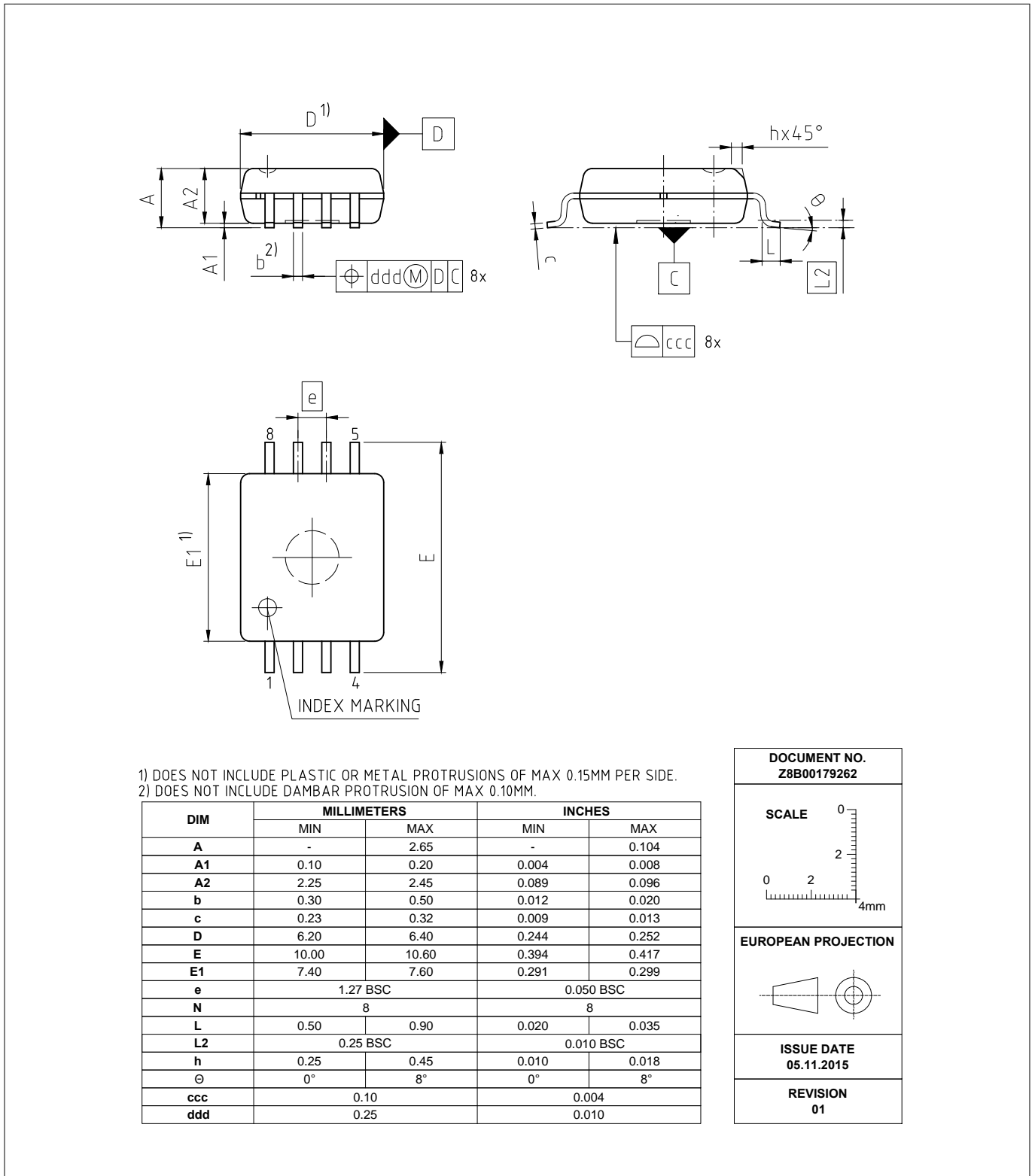

Figure 9 PG-DSO-8-59 (Plastic (Green) Dual Small Outline Package)

6 Application Notes

6.1 Reference Layout for Thermal Data

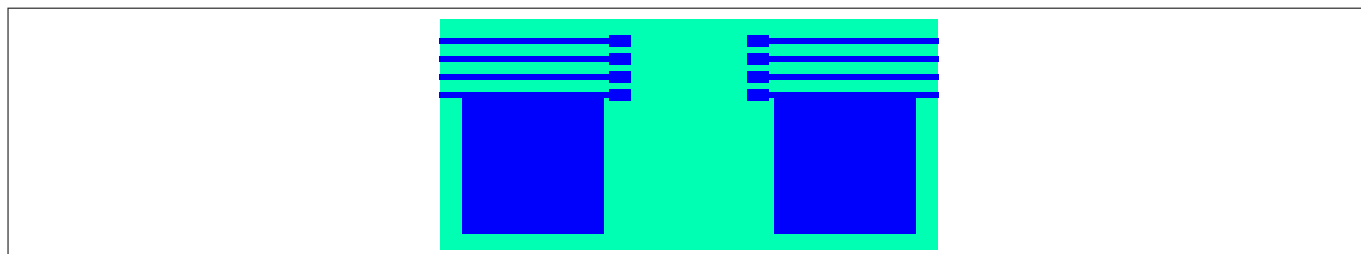

Figure 10 Reference Layout for Thermal Data (Copper thickness 35 μm)

This PCB layout represents the reference layout used for the thermal characterization.

Pin 4 (GND1) and pin 5 (GND2) require each a ground plane of 100 mm² for achieving maximum power dissipation. The package is built to dissipate most of the heat generated through these pins.

The thermal coefficient junction-top ($\Psi_{th,jt}$) can be used to calculate the junction temperature at a given top case temperature and driver power dissipation:

$$T_j = \Psi_{th,jt} \cdot P_D + T_{top}$$

6.2 Printed Circuit Board Guidelines

The following factors should be taken into account for an optimum PCB layout.

- Sufficient spacing should be kept between high voltage isolated side and low voltage side circuits.
- The same minimum distance between two adjacent high-side isolated parts of the PCB should be maintained to increase the effective isolation and to reduce parasitic coupling.
- In order to ensure low supply ripple and clean switching signals, bypass capacitor trace lengths should be kept as short as possible.

Revision History

Page or Item	Subjects (major changes since previous revision)
Rev. 2.0, 2016-07-05	
Logic Input	extended description of VCC1 scaled input thresholds
Rev. 1.0, 2016-04-20	
el. Parameters	missing product parameters updated
Rev. 0.51, 2015-11-05	
all pages	change of template, standardized package drawing included
Rev. 0.50, 2014-05-05	
all pages	initial version

Trademarks of Infineon Technologies AG

μ HVIC™, μ IPM™, μ PFC™, AU-ConvertIR™, AURIX™, C166™, CanPAK™, CIPOS™, CIPURSE™, CoolDP™, CoolGaN™, COOLiR™, CoolMOS™, CoolSET™, CoolSiC™, DAVE™, DI-POL™, DirectFET™, DrBlade™, EasyPIM™, EconoBRIDGE™, EconoDUAL™, EconoPACK™, EconoPIM™, EiceDRIVER™, eupec™, FCOS™, GaNpowIR™, HEXFET™, HITFET™, HybridPACK™, iMOTION™, IRAM™, ISOFACE™, IsoPACK™, LEDriviR™, LITIX™, MIPAQ™, ModSTACK™, my-d™, NovalithiC™, OPTIGA™, OptiMOS™, ORIGA™, PowIRaudio™, PowIRstage™, PrimePACK™, PrimeSTACK™, PROFET™, PRO-SiL™, RASIC™, REAL3™, SmartLEWIS™, SOLID FLASH™, SPOC™, StrongIRFET™, SuplIRBuck™, TEMPFET™, TRENCHSTOP™, TriCore™, UHVIC™, XHP™, XMC™.

Trademarks Update 2015-12-22

Other Trademarks

All referenced product or service names and trademarks are the property of their respective owners.

Edition 2016-07-05

Published by

Infineon Technologies AG

81726 Munich, Germany

© 2016 Infineon Technologies AG

All Rights Reserved.

Do you have a question about any aspect of this document?

Email: erratum@infineon.com

Document reference

IFX-ret1441196173716

IMPORTANT NOTICE

The information given in this document shall in no event be regarded as a guarantee of conditions or characteristics ("Beschaffenhheitsgarantie").

With respect to any examples, hints or any typical values stated herein and/or any information regarding the application of the product, Infineon Technologies hereby disclaims any and all warranties and liabilities of any kind, including without limitation warranties of non-infringement of intellectual property rights of any third party.

In addition, any information given in this document is subject to customer's compliance with its obligations stated in this document and any applicable legal requirements, norms and standards concerning customer's products and any use of the product of Infineon Technologies in customer's applications.

The data contained in this document is exclusively intended for technically trained staff. It is the responsibility of customer's technical departments to evaluate the suitability of the product for the intended application and the completeness of the product information given in this document with respect to such application.

Please note that this product is not qualified according to the AEC Q100 or AEC Q101 documents of the Automotive Electronics Council.

WARNINGS

Due to technical requirements products may contain dangerous substances. For information on the types in question please contact your nearest Infineon Technologies office.

Except as otherwise explicitly approved by Infineon Technologies in a written document signed by authorized representatives of Infineon Technologies, Infineon Technologies' products may not be used in any applications where a failure of the product or any consequences of the use thereof can reasonably be expected to result in personal injury

Mouser Electronics

Authorized Distributor

Click to View Pricing, Inventory, Delivery & Lifecycle Information:

[Infineon:](#)

[1EDI60I12AHXUMA1](#) [1EDI60H12AHXUMA1](#) [1EDI40I12AHXUMA1](#) [1EDI20H12AHXUMA1](#) [1EDI20I12AHXUMA1](#)
[1EDI05I12AHXUMA1](#)