

Pin Configuration

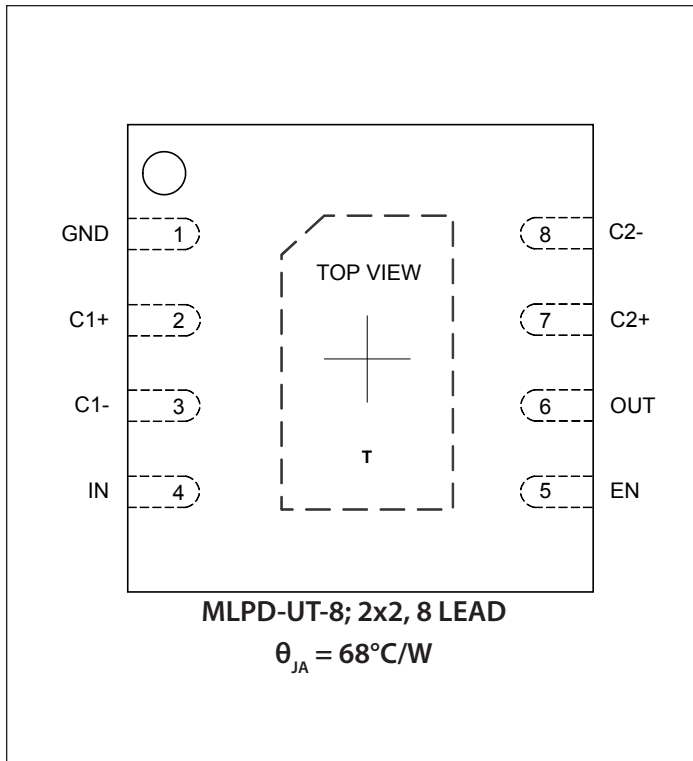

Ordering Information

Device	Package
SC632AULTRT ⁽¹⁾⁽²⁾	MLPD-UT-8 2x2
SC632AEVB	Evaluation Board

Notes:

- (1) Available in tape and reel only. A reel contains 3,000 devices.
- (2) Lead-free packaging only. Device is WEEE and RoHS compliant, and halogen-free.

Marking Information

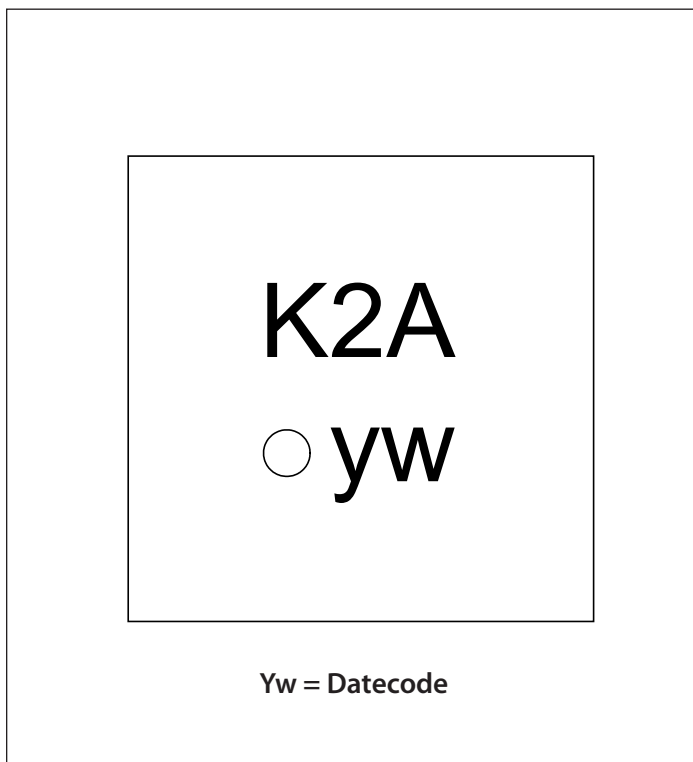

Absolute Maximum Ratings

IN (V)	-0.3 to +6.0
OUT (V).....	-0.3 to +6.0
C1+, C2+ (V).....	-0.3 to ($V_{OUT} + 0.3$)
Pin Voltage — All Other Pins (V)	-0.3 to ($V_{IN} + 0.3$)
OUT pin — Short Circuit Duration	Continuous
ESD Protection Level ⁽²⁾ (kV)	4

Recommended Operating Conditions

Ambient Temperature Range (°C)	$-40 \leq T_A \leq +85$
IN (V)	$2.95 \leq V_{IN} \leq 5.5$

Thermal Information

Thermal Resistance, Junction to Ambient ⁽¹⁾ (°C/W)	68
Maximum Junction Temperature (°C)	+150
Storage Temperature Range (°C).....	-65 to +150
Peak IR Reflow Temperature (10s to 30s) (°C)	+260

Exceeding the above specifications may result in permanent damage to the device or device malfunction. Operation outside of the parameters specified in the Electrical Characteristics section is not recommended.

NOTES

- (1) Calculated from package in still air, mounted to 3 x 4.5 (in), 4 layer FR4 PCB with thermal vias under the exposed pad per JESD51 standards.
- (2) Tested according to JEDEC standard JESD22-A114-B.

Electrical Characteristics

Unless otherwise specified: $T_A = +25^\circ\text{C}$ for Typ, -40°C to $+85^\circ\text{C}$ for Min and Max; $C_{IN} = C_{OUT} = C_1 = C_2 = 2.2\mu\text{F}$ (ESR < 0.03Ω); $V_{IN} = 2.95\text{V}$ to 5.5V

Parameter	Symbol	Condition	Min	Typ	Max	Units
Output Voltage	V_{OUT}	$V_{IN} = 4.2\text{V}, I_{OUT} = 1\text{mA}$	4.85	5.0	5.15	V
Output Voltage Ripple	V_{PP}	$I_{OUT} = 275\text{mA}$		50		mV
Maximum Output Current	I_{OUT}	Peak Load - thermally limited ⁽¹⁾ , $T_J < 150^\circ\text{C}, 3.4\text{V} \leq V_{IN} \leq 5.5\text{V}$	400			mA
		Continuous Load, $3.10\text{V} \leq V_{IN} \leq 4.2\text{V}$	275			mA
Shutdown Current	I_{SD}	Shutdown (EN = GND), $V_{IN} = 3.6\text{V}$		0.1	2	μA
Total Quiescent Current	I_Q	EN high, $I_{OUT} = 1\text{mA}$		2.5	3.5	mA
Charge Pump Frequency	f_{PUMP}	$V_{IN} = 3.2\text{V}$		1		MHz
Start-Up Time	t_{SU}	(EN transitions from low to high), $4.85\text{V} \leq V_{OUT} \leq 5.15\text{V}$, No load		400		μs
Line Regulation	ΔV_{LINE}	$I_{OUT} = 1\text{mA}, 2.95\text{V} \leq V_{IN} \leq 4.2\text{V}$			21	mV
Load Regulation	ΔV_{LOAD}	$V_{IN} = 4.2\text{V}, 1\text{mA} \leq I_{OUT} \leq 400\text{mA}$			37.5	mV

Electrical Characteristics (continued)

Parameter	Symbol	Condition	Min	Typ	Max	Units
EN Input High Threshold	V_{IH}	$V_{IN} = 5.5V$	1.6			V
EN Input Low Threshold	V_{IL}	$V_{IN} = 2.95V$			0.4	V
EN Input High Current	I_{IH}	$V_{IN} = 5.5V$			2	μA
EN Input Low Current	I_{IL}	$V_{IN} = 5.5V$			2	μA
Open-Loop Output Resistance	R_{OUT}	1x mode		0.25		Ω
		1.5x mode, $V_{IN} = 3.7V$		3.5		Ω
		2x mode, $V_{IN} = 3.1V$		4.5		Ω
Mode Transition Voltage ⁽²⁾	$V_{TRANS\ 1X}$	$I_{OUT} = 200mA$		5.05		V
	$V_{TRANS\ 1.5X}$	$I_{OUT} = 200mA$		3.8		V
Fault Protection						
Short-Circuit Current	I_{SC}	$V_{OUT} = 0V, I_{OUT} = I_{IN}$	300	600	980	mA
Input Current Limit	I_{LIMIT}	$V_{OUT} > 2V, 1x\ mode$	0.6	1.2	2.0	A
		$V_{OUT} > 2V, 1.5x\ and\ 2x\ modes$	1.2	2.0	2.8	A
		$V_{OUT} \leq 2V, I_{OUT} = I_{IN}$		700		mA
Over Temperature	T_{OTP}	Rising Threshold		165		$^{\circ}C$
	T_{HYS}	Hysteresis ⁽³⁾		20		$^{\circ}C$

Notes:

- (1) Thermal limitation is dependent upon the thermal performance of the printed circuit board in support of the package standard of 68° C/W.
- (2) Voltage at the IN pin where a mode transition takes place in the charge pump with V_{IN} falling.
- (3) Guaranteed by design — not tested in production.

Typical Characteristics

Load Regulation

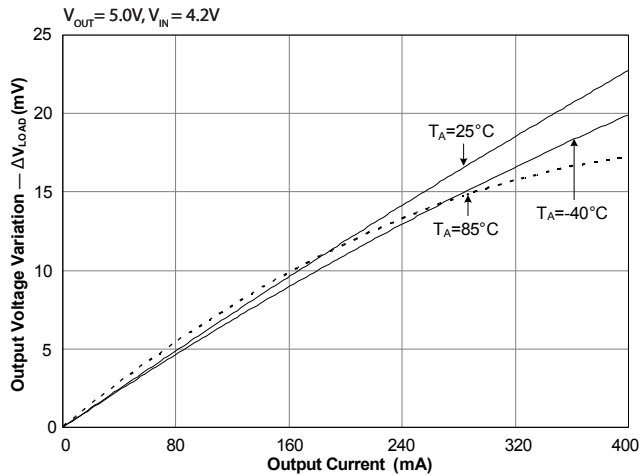

Line Regulation

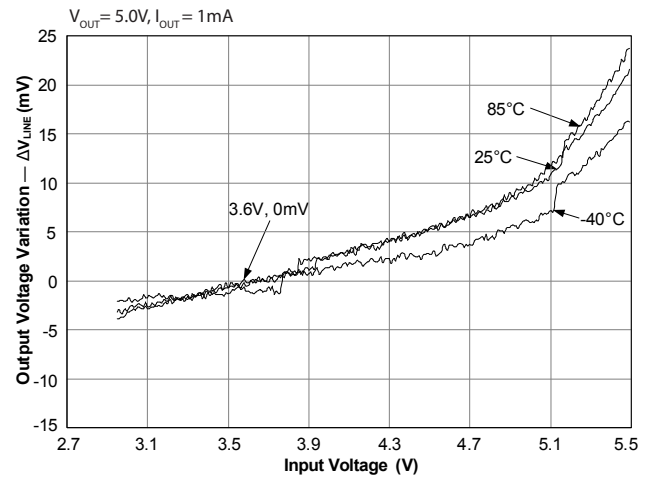

PSRR versus Frequency — 1x Mode

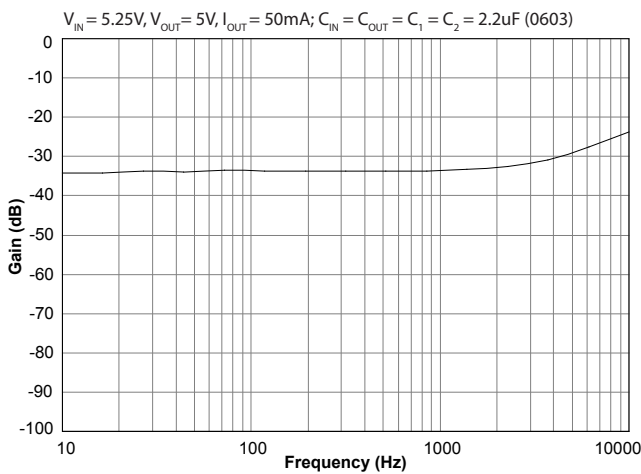

Output Ripple

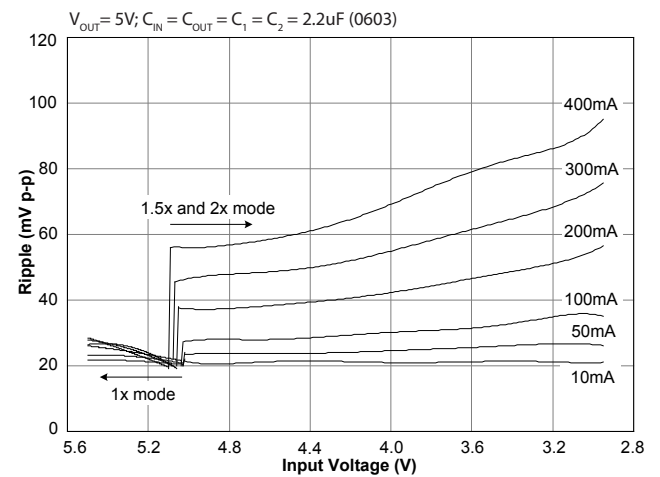

PSRR versus Frequency — 1.5x Mode

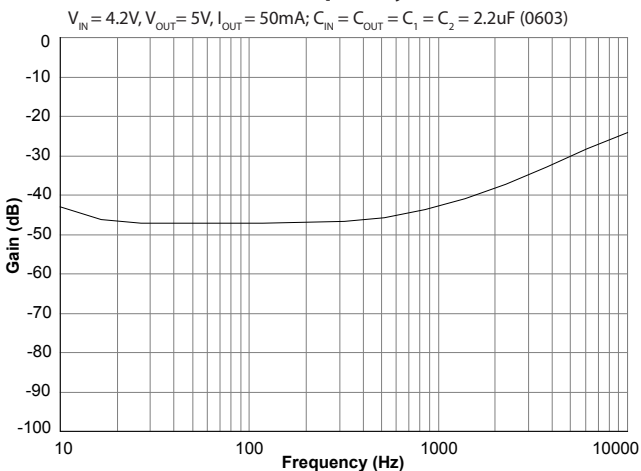

PSRR versus Frequency — 2x Mode

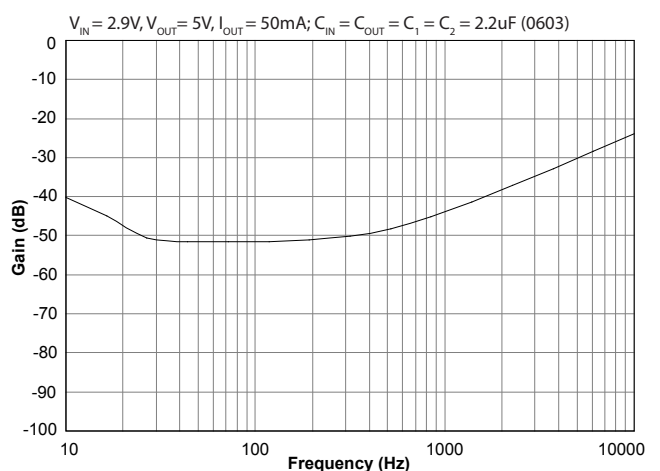

Typical Characteristics (continued)

Efficiency — 10mA

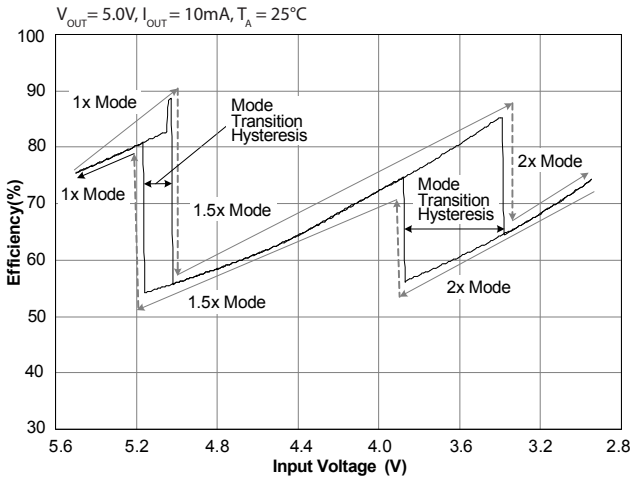

Efficiency — 50mA

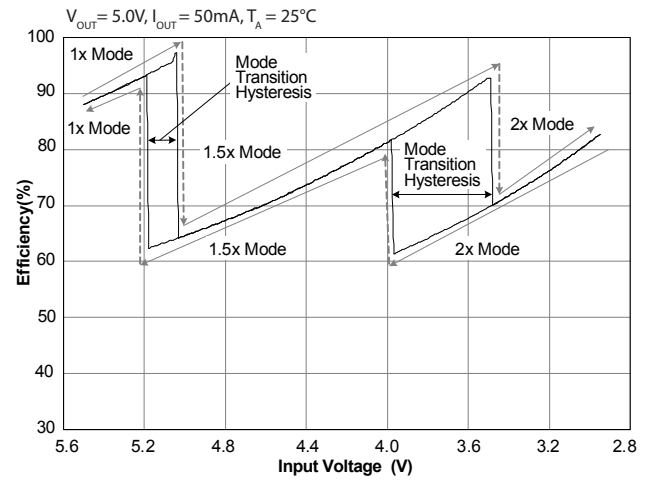

Efficiency — 100mA

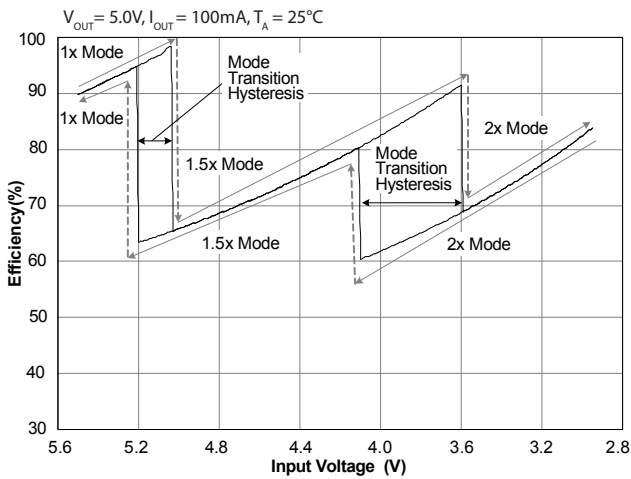

Efficiency — 200mA

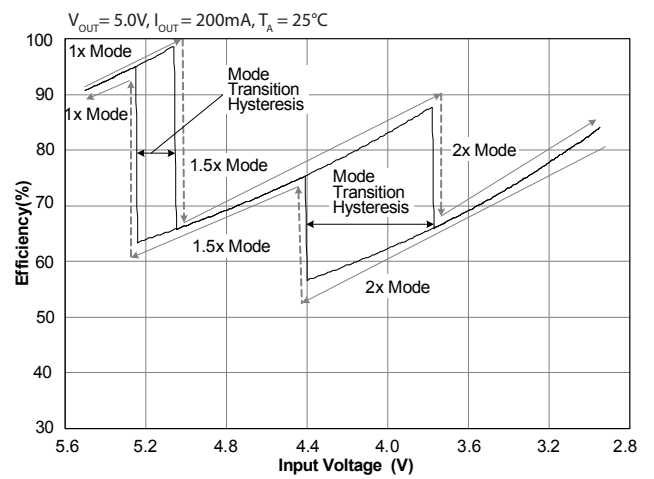

Efficiency — 300mA

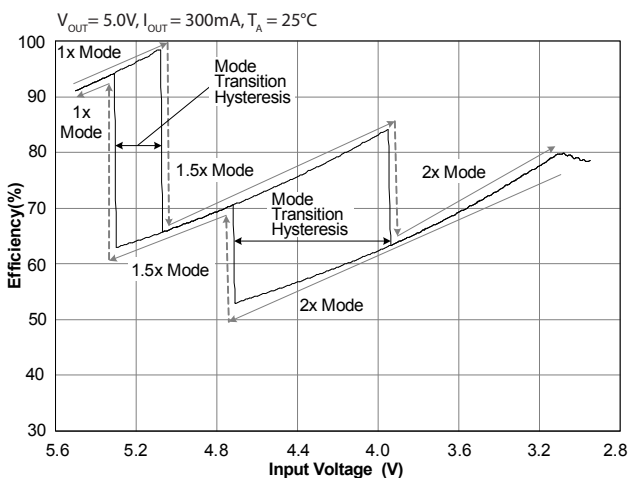

Efficiency — 400mA

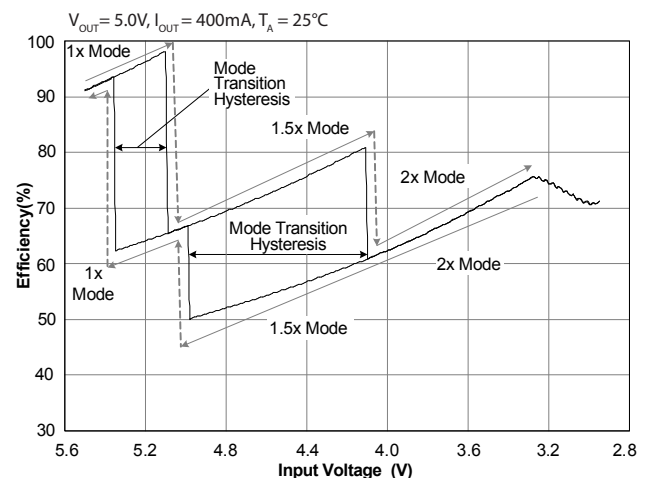

Typical Characteristics (continued)

Ripple — 1x Mode

$V_{IN} = 5.2V, V_{OUT} = 5.0V, I_{OUT} = 275mA; C_{IN} = C_{OUT} = C_1 = C_2 = 2.2\mu F (0603)$

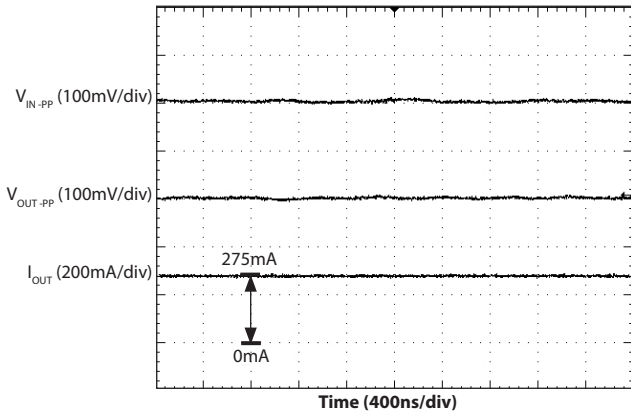

Ripple — 1.5x Mode

$V_{IN} = 4.2V, V_{OUT} = 5.0V, I_{OUT} = 275mA; C_{IN} = C_{OUT} = C_1 = C_2 = 2.2\mu F (0603)$

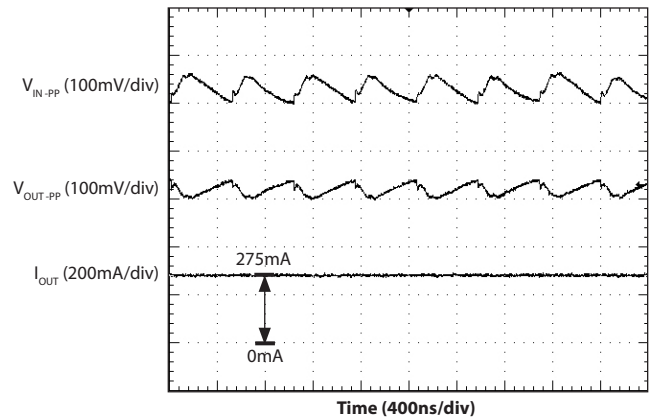

Ripple — 2x Mode

$V_{IN} = 3.2V, V_{OUT} = 5.0V, I_{OUT} = 275mA; C_{IN} = C_{OUT} = C_1 = C_2 = 2.2\mu F (0603)$

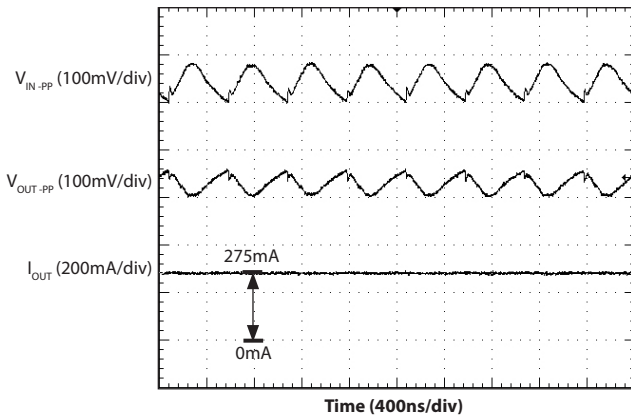

Startup (No Load)

$V_{IN} = 3.6V, I_{OUT} = 0mA; C_{IN} = C_{OUT} = C_1 = C_2 = 2.2\mu F (0603)$

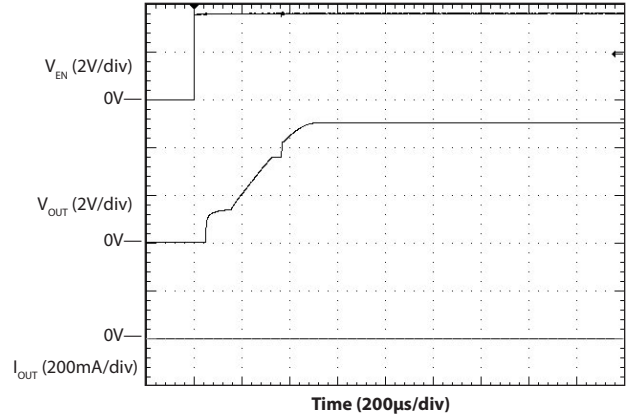

Startup (400mA)

$V_{IN} = 3.6V, I_{OUT} = 400mA; C_{IN} = C_{OUT} = C_1 = C_2 = 2.2\mu F (0603)$

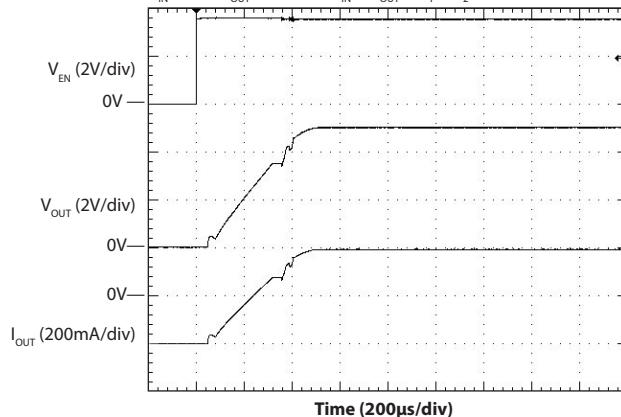

Quiescent Current

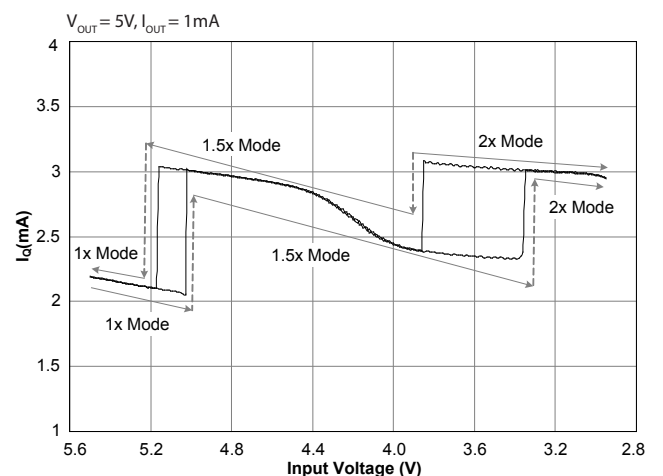

Pin Descriptions

Pin	Pin Name	Pin Function
1	GND	Ground — connect to ground plane with multiple vias
2	C1+	Positive terminal of bucket capacitor 1
3	C1-	Negative terminal of bucket capacitor 1
4	IN	Input supply voltage
5	EN	Chip enable — active-high
6	OUT	Output
7	C2+	Positive terminal of bucket capacitor 2
8	C2-	Negative terminal of bucket capacitor 2
T	Thermal Pad	This pad is for heat sinking and is not connected internally. It must be connected to a ground plane using multiple vias.

Block Diagram

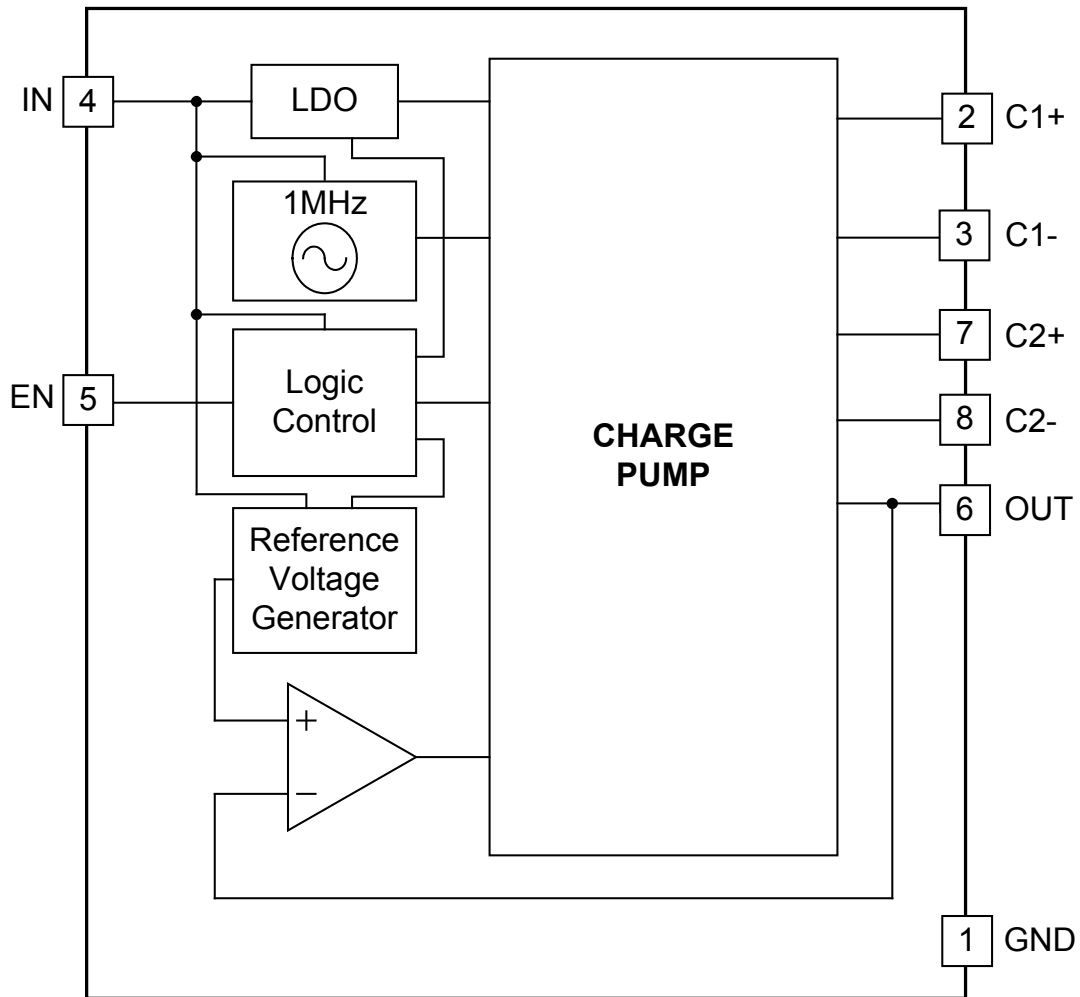

Applications Information

General Description

The SC632A is a 5.0V output charge pump regulator designed to support up to 300mA ($T_A \leq 80^\circ\text{C}$, $3.15\text{V} \leq V_{\text{IN}} \leq 4.2\text{V}$) and 275mA ($T_A \leq 85^\circ\text{C}$, $3.15\text{V} \leq V_{\text{IN}} \leq 5.5\text{V}$) of continuous current for powering 5.0V devices in portable handheld equipment including Compact Flash and CF+ products.

The SC632A has three operating modes — 1x, 1.5x, and 2x. The 1x mode is a linear series regulation mode with a low open-loop output resistance of only 250m Ω . The 1x mode functions as a low-noise series linear regulator. The 1.5x and 2x modes are a low noise, constant frequency, constant duty cycle switch mode, using two bucket capacitors. One bucket supports the full output current while the other bucket charges from the input. The two buckets exchange roles in the next phase, supplying continuous output current in both phases and reducing the need for a large output decoupling capacitor. The constant frequency, constant duty cycle operation also produces predictable constant frequency harmonics.

Mode Transition Hysteresis

Hysteresis is provided to prevent chatter between charge pump modes for input steps of up to 120mV. Decouple the input to prevent steps greater than 120mV, for optimum transient performance, when the input voltage reaches the mode transition thresholds.

Thermal Resistance

The SC632A package is thermally efficient when the circuit board layout connects the thermal pad through multiple vias to the ground plane. The thermal resistance rating is dependent upon the connection between the thermal pad and the ground plane. A layout that is done correctly should keep the junction temperature below the over-temperature limit while operating the SC632A within the specified electrical conditions. A poor layout may allow the junction temperature to reach the over temperature limit, so it is important to maintain adequate ground plane around the device to maximize heat transfer to the PCB.

Temperature Derating

The V_{IN} supply range and ambient temperature range of the application should be compared with the following derating curve to determine the maximum safe continuous load current. The DC operating points beneath each curve are in the safe operating temperature range of the MLP package.

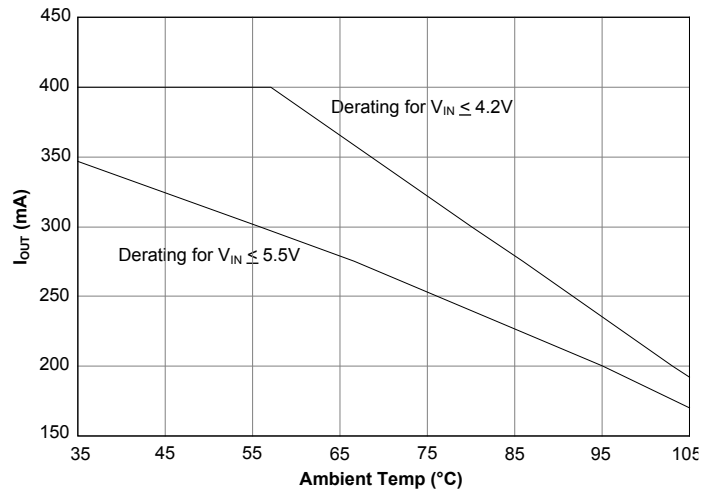

Maximum Continuous Output

Protection Circuitry

The SC632A also provides protection circuitry that prevents the device from operating in an unspecified state. These functions include:

- Over-Current Protection (OCP)
- Short-Circuit Current Protection (SCCP)
- Over-Temperature Protection (OTP)

Over-Current Protection

Over-current protection is provided to limit the output current. When V_{OUT} is greater than 2V, OCP limits the output to 1A typical. The threshold at 2V allows the device to recover from excessive voltage droop during an over current.

Applications Information (continued)

Short-Circuit Current Protection

Short-circuit current protection is provided to limit the current that can be sourced when the output is shorted to ground. When a short circuit forces V_{OUT} to drop below 2V, the SCCP detects the condition and limits the output current to 600mA (typical).

Over-Temperature Protection

The over-temperature circuit helps prevent the device from overheating and experiencing a catastrophic failure. When the junction temperature exceeds 165°C, the device is disabled. It remains disabled until the junction temperature drops below this threshold. Hysteresis is included that prevents the device from re-enabling until the junction temperature is reduced by 20°C.

Capacitor Selection

The SC632A is designed to use low-ESR ceramic capacitors for the input and output bypass capacitors as well as the charge pump bucket capacitors. The value of input, output and decoupling capacitors will vary with system requirements for ripple and output current. Performance as shown in the Typical Characteristic section is expected when using 2.2 μ F capacitors in the 0603(1608 metric) case size with X5R dielectric for C_{IN} , C_{OUT} , C_1 and C_2 capacitors (refer to Table 1).

Consider the DC voltage characteristic of the capacitor when choosing capacitors for an application. The value of capacitance at the DC operating voltage may be considerably lower than the rated value. The following table lists recommended capacitor values which have been chosen to minimize the impact of this limitation.

The highest capacitance values in the smallest package sizes tend to have poor DC voltage characteristics. The highest value 0402 size capacitor retains as little as 35% of its rated value at 5VDC. The same value chosen in the next larger package size, 0603, will retain about 60% of its rated value at 5VDC.

Table 1 — Recommended Capacitors

Size Code mil(mm)	Value μ F	Capacitor	Notes
0603(1608)	2.2	C_{IN}, C_{OUT}	This capacitor is required for the full rated output current. Typical output $V_{pp} < 100$ mV in all charge pump modes.
		C_1, C_2	
0402(1005)	2.2	C_{IN}, C_{OUT}	This capacitor combination supports up to 200mA output current with typical output $V_{pp} < 100$ mV in all charge pump modes.
		C_1, C_2	
0402(1005)	0.47	C_{IN}, C_{OUT}	This capacitor combination supports up to 100mA output current with typical output $V_{pp} < 100$ mV in all charge pump modes.
		C_1, C_2	
0402(1005)	1.0	C_{IN}, C_{OUT}	This combination of capacitors support up to 100mA output current with typical output $V_{pp} < 100$ mV in all charge pump modes.
	0.1	C_1, C_2	

NOTE: Use only X5R type capacitors, with a 6.3V rating or higher

Applications Information (continued)

PCB Layout Considerations

Poor layout can degrade the performance of the regulator and can be a contributory factor in EMI problems, ground bounce, thermal issues, and resistive voltage losses. Poor regulation and instability can result.

The following design rules are recommended:

1. Place the bucket capacitors as close to the device as possible and on the same side of the board. Use short wide copper areas between the capacitor pins and the device pins.
2. Place the input and output decoupling capacitors as close as possible to the device and connect these capacitors' ground pads together to the ground plane using multiple vias through a short wide copper area.
3. Connect pin 1 directly to the copper area under the thermal pad.
4. The thermal pad at the center of the device is not electrically connected. Connect this pad to the ground plane using multiple vias.
5. Use a ground plane to further reduce noise interference on sensitive circuit nodes.

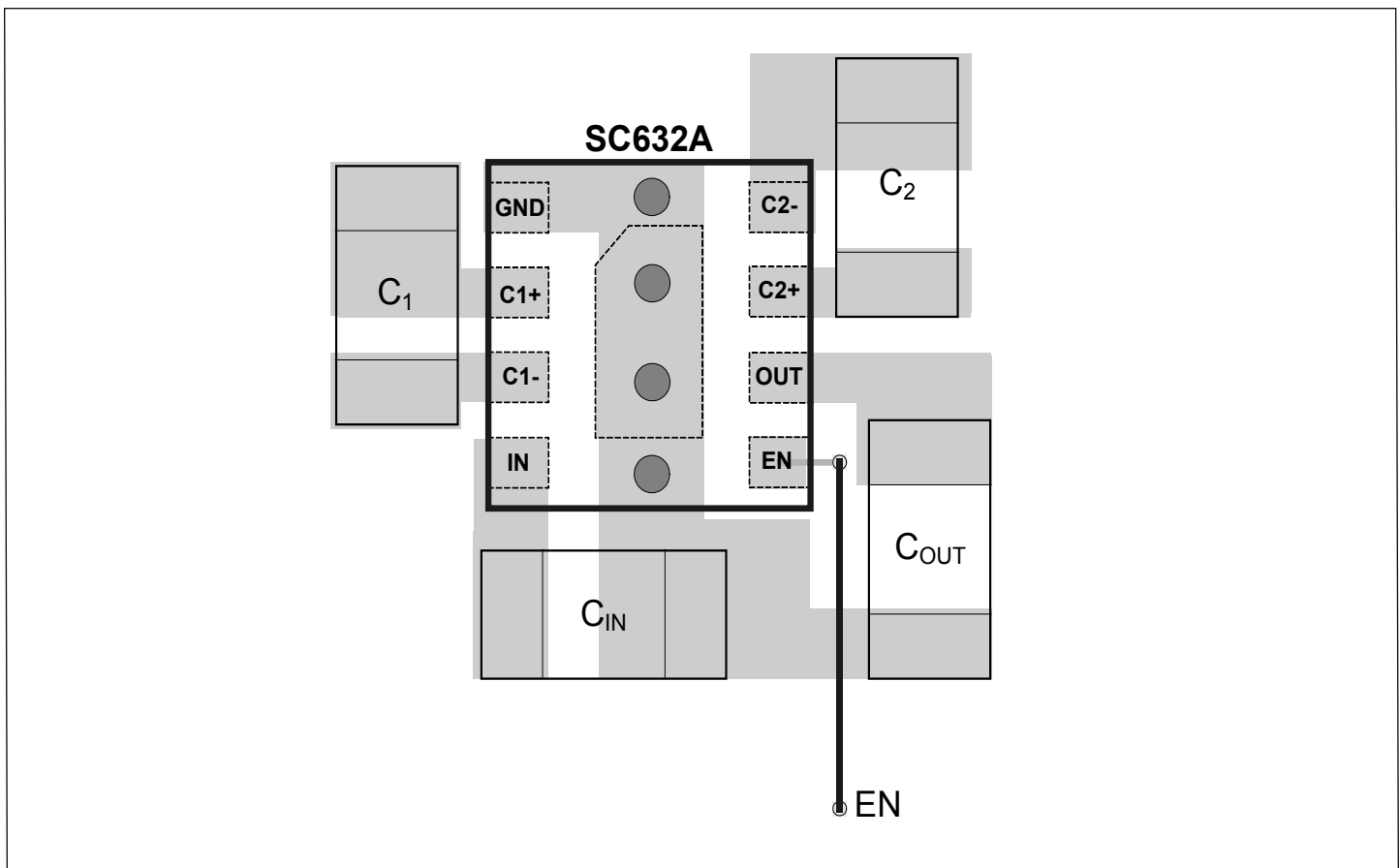

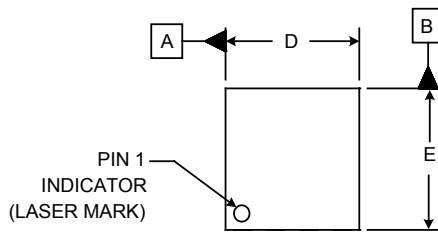
Outline Drawing — MLPD-UT-8 2x2

DIM	INCHES			MILLIMETERS		
	MIN	NOM	MAX	MIN	NOM	MAX
A	.020	-	.024	0.50	-	0.60
A1	.000	-	.002	0.00	-	0.05
A2	(.006)			(0.1524)		
b	.007	.010	.012	0.18	0.25	0.30
D	.075	.079	.083	1.90	2.00	2.10
D1	.061	.067	.071	1.55	1.70	1.80
E	.075	.079	.083	1.90	2.00	2.10
E1	.026	.031	.035	0.65	0.80	0.90
e	.020 BSC			0.50 BSC		
L	.012	.014	.016	0.30	0.35	0.40
N	8			8		
aaa	.003			0.08		
bbb	.004			0.10		

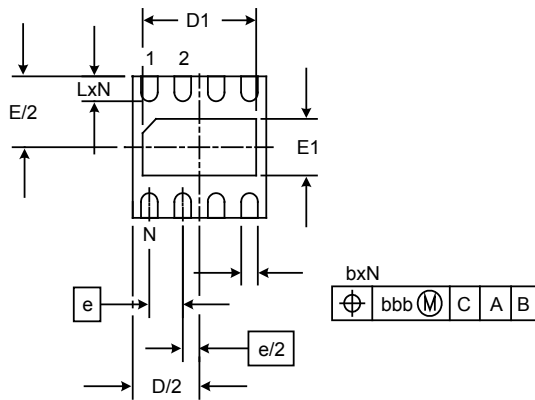
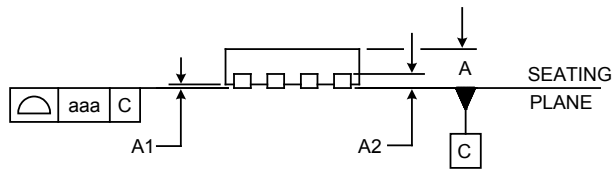
NOTES:

1. CONTROLLING DIMENSIONS ARE IN MILLIMETERS (ANGLES IN DEGREES).
2. COPLANARITY APPLIES TO THE EXPOSED PAD AS WELL AS THE TERMINALS.

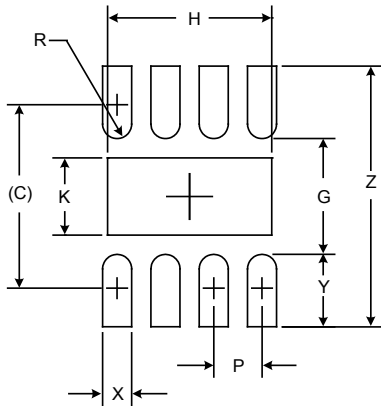
Land Pattern — MLPD-UT-8 2x2

DIMENSIONS		
DIM	INCHES	MILLIMETERS
C	(.077)	(1.95)
G	.047	1.20
H	.067	1.70
K	.031	0.80
P	.020	0.50
R	.006	0.15
X	.012	0.30
Y	.030	0.75
Z	.106	2.70

NOTES:

1. CONTROLLING DIMENSIONS ARE IN MILLIMETERS (ANGLES IN DEGREES).
2. THIS LAND PATTERN IS FOR REFERENCE PURPOSES ONLY. CONSULT YOUR MANUFACTURING GROUP TO ENSURE YOUR COMPANY'S MANUFACTURING GUIDELINES ARE MET.
3. THERMAL VIAS IN THE LAND PATTERN OF THE EXPOSED PAD SHALL BE CONNECTED TO A SYSTEM GROUND PLANE. FAILURE TO DO SO MAY COMPROMISE THE THERMAL AND/OR FUNCTIONAL PERFORMANCE OF THE DEVICE.

© Semtech 2011

All rights reserved. Reproduction in whole or in part is prohibited without the prior written consent of the copyright owner. The information presented in this document does not form part of any quotation or contract, is believed to be accurate and reliable and may be changed without notice. No liability will be accepted by the publisher for any consequence of its use. Publication thereof does not convey nor imply any license under patent or other industrial or intellectual property rights. Semtech assumes no responsibility or liability whatsoever for any failure or unexpected operation resulting from misuse, neglect improper installation, repair or improper handling or unusual physical or electrical stress including, but not limited to, exposure to parameters beyond the specified maximum ratings or operation outside the specified range.

SEMTECH PRODUCTS ARE NOT DESIGNED, INTENDED, AUTHORIZED OR WARRANTED TO BE SUITABLE FOR USE IN LIFE-SUPPORT APPLICATIONS, DEVICES OR SYSTEMS OR OTHER CRITICAL APPLICATIONS. INCLUSION OF SEMTECH PRODUCTS IN SUCH APPLICATIONS IS UNDERSTOOD TO BE UNDERTAKEN SOLELY AT THE CUSTOMER'S OWN RISK. Should a customer purchase or use Semtech products for any such unauthorized application, the customer shall indemnify and hold Semtech and its officers, employees, subsidiaries, affiliates, and distributors harmless against all claims, costs damages and attorney fees which could arise.

Notice: All referenced brands, product names, service names and trademarks are the property of their respective owners.

Contact Information

Semtech Corporation
Power Management Products Division
200 Flynn Road, Camarillo, CA 93012
Phone: (805) 498-2111 Fax: (805) 498-3804

www.semtech.com

Mouser Electronics

Authorized Distributor

Click to View Pricing, Inventory, Delivery & Lifecycle Information:

[Semtech:](#)

[SC632AULTRT](#)