

<b>ABSOLUTE MAXIMUM RATINGS</b> ( $T_A = 25^\circ\text{C}$ unless otherwise specified) <sup>(Note 1)</sup>				
PARAMETER		SYMBOL	LIMIT	UNIT
Input Supply Voltage		$V_{IN}$	12	V
Output Current		$I_{OUT}$	250	mA
Power Dissipation	SOT-23	$P_D$	0.30	W
	SOT-89		0.50	
Operating Ambient Temperature		$T_{OPR}$	-40 ~ +85	$^\circ\text{C}$
Junction Temperature Range		$T_J$	-40 ~ +150	$^\circ\text{C}$
Storage Temperature Range		$T_{STG}$	-65 ~ +150	$^\circ\text{C}$

<b>THERMAL PERFORMANCE</b>				
PARAMETER		SYMBOL	LIMIT	UNIT
Thermal Resistance - Junction to Ambient	SOT-23	$R_{\theta JA}$	333	$^\circ\text{C/W}$
	SOT-89		200	

Note: Measured with FR4 4-layer board having thermal via holes

<b>ELECTRICAL SPECIFICATIONS</b> ( $T_A = 25^\circ\text{C}$ unless otherwise specified)						
PARAMETER	CONDITION		MIN	TYP	MAX	UNIT
Output Voltage	$V_{IN}=V_O + 1V,$ $I_O=40mA,$	TS90115	4.90	5.0	5.10	V
		TS9011S	3.23	3.3	3.36	
		TS9011P	2.94	3.0	3.06	
		TS9011K	2.45	2.5	2.55	
		TS9011D	1.76	1.8	1.83	
Maximum Output Current	$V_{IN}=V_O+1V,$		250	--	--	mA
Input Stability	$V_O+1V \leq V_{IN} \leq V_O+2V, I_O=1mA$		--	0.2	0.3	%
Load Regulation <sup>(Note1)</sup>	$V_{IN}=V_O+1V,$ $1mA \leq I_L \leq 100mA$	TS90115	--	40	80	mV
		TS9011S				
	$V_{IN}=V_O+1V,$ $1mA \leq I_L \leq 80mA$	TS9011P	--	40	90	
		TS9011K				
Dropout Voltage <sup>(Note 2)</sup>	$I_O=250mA$	TS90115	--	400	600	mV
	$I_O=200mA$	TS9011S	--	400	650	
	$I_O=160mA$	TS9011P	--	400	700	
	$I_O=160mA$	TS9011K	--	400	700	
	$I_O=120mA$	TS9011D	--	400	750	
Quiescent Current	$V_{IN}=V_O+1V, I_O=0A$		--	2	5	$\mu\text{A}$
Output Current Limit	$V_{OUT} < 0.4V$		--	400	--	mA
Power Supply Rejection Ratio	At $f=100kHz, I_O=10mA,$		--	30	--	dB
Output Voltage Temperature Coefficient <sup>(Note 3)</sup>			--	100	--	ppm/ $^\circ\text{C}$

**Note:**

1. Regulation is measured at constant junction temperature, using pulsed ON time.
2. Dropout is measured at constant junction temperature, using pulsed ON time, and the criterion is  $V_{OUT}$  inside target value +/-2%.
3. Guaranteed by design.

**ORDERING INFORMATION**

OUTPUT VOLTAGE	PART NO.	PACKAGE	PACKING
1.8V	TS9011DCX RFG	SOT-23	3,000pcs / 7" Reel
	TS9011DCY RMG	SOT-89	1,000pcs / 7" Reel
2.5V	TS9011KCX RFG	SOT-23	3,000pcs / 7" Reel
	TS9011KCY RMG	SOT-89	1,000pcs / 7" Reel
3.0V	TS9011PCY RMG	SOT-89	1,000pcs / 7" Reel
3.3V	TS9011SCX RFG	SOT-23	3,000pcs / 7" Reel
	TS9011SCY RMG	SOT-89	1,000pcs / 7" Reel
5V	TS90115CX RFG	SOT-23	3,000pcs / 7" Reel
	TS90115CY RMG	SOT-89	1,000pcs / 7" Reel

**FUNCTION BLOCK DIAGRAM**

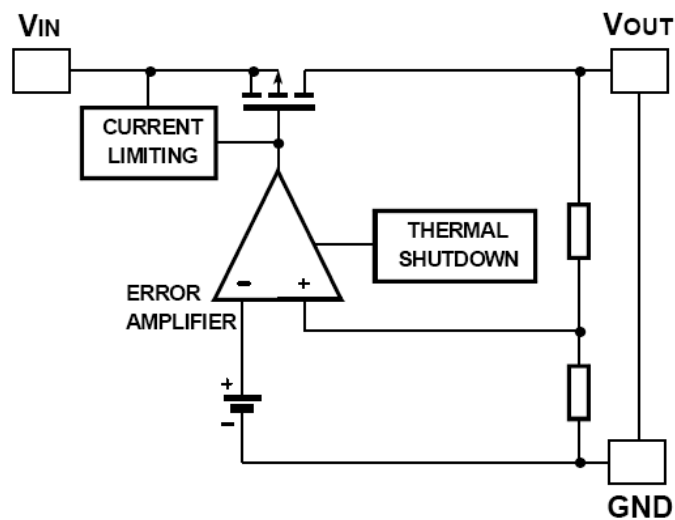

**ELECTRICAL CHARACTERISTICS CURVES** ( $T_A=25^{\circ}\text{C}$ , unless otherwise noted)

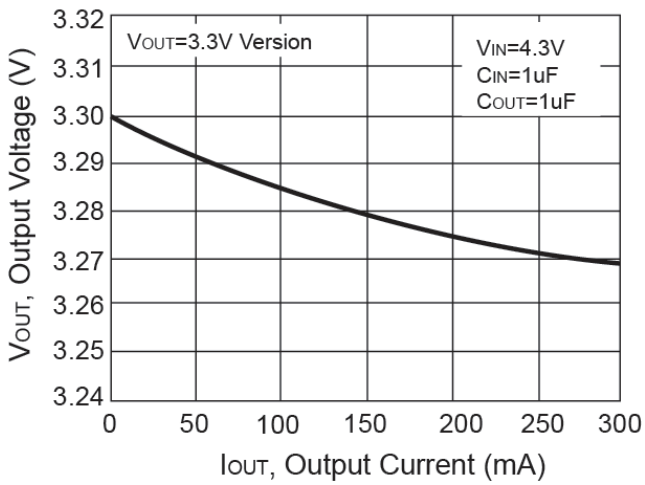

**Figure 1. Output Voltage vs. Output Current**

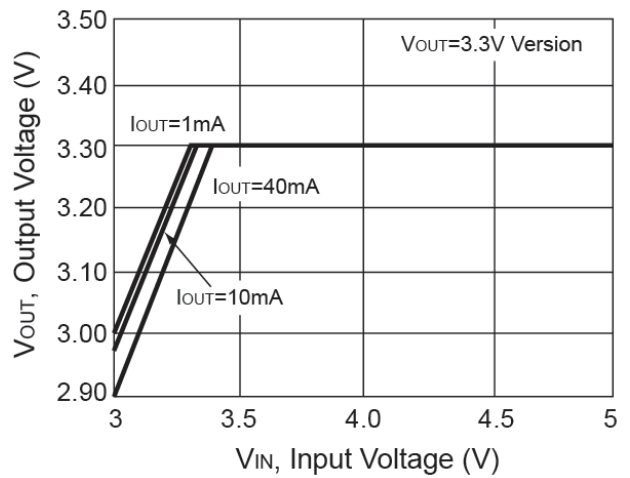

**Figure 2. Output Voltage vs. Input Voltage**

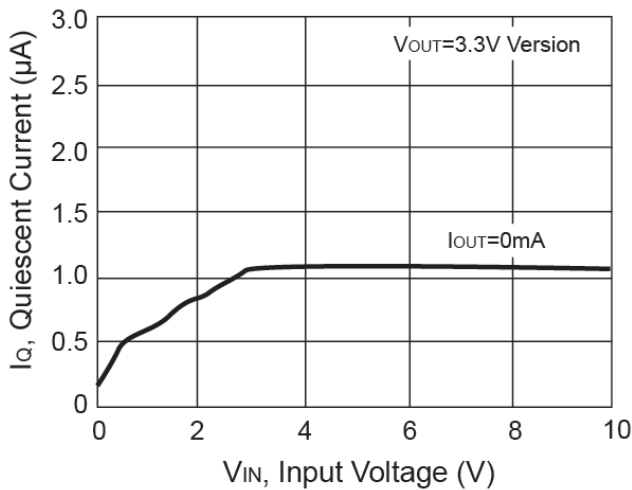

**Figure 3. Quiescent Current vs. Input Voltage**

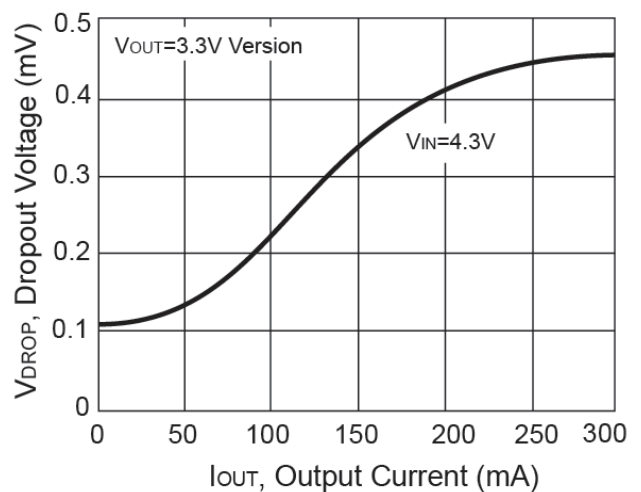

**Figure 4. Short Circuit Current vs. Input Voltage**

**PACKAGE OUTLINE DIMENSIONS** (Unit: Millimeters)

**SOT-23**

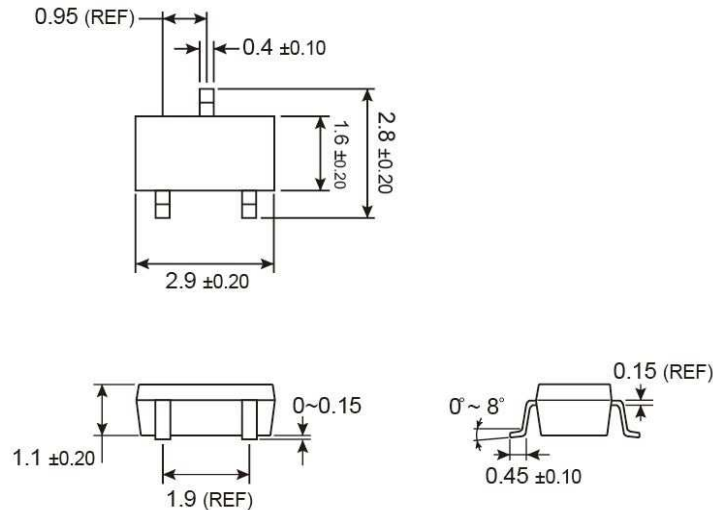

**SUGGESTED PAD LAYOUT** (Unit: Millimeters)

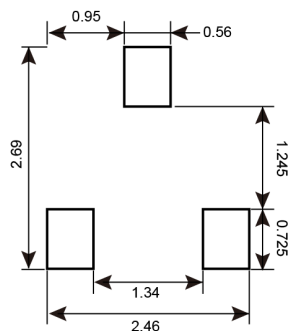

**MARKING DIAGRAM**

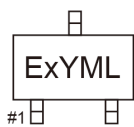

- E** = Product Code
- Y** = Year Code
- M** = Month Code for Halogen Free Product
  - O** =Jan    **P** =Feb    **Q** =Mar    **R** =Apr
  - S** =May    **T** =Jun    **U** =Jul    **V** =Aug
  - W** =Sep    **X** =Oct    **Y** =Nov    **Z** =Dec
- L** = Lot Code (1~9, A~Z)
- X** = Fixed Output Voltage Code
  - A**=1.5V, **D**=1.8V, **K**=2.5V, **P**=3.0V, **S**=3.3V, **5**=5.0V.

**PACKAGE OUTLINE DIMENSIONS** (Unit: Millimeters)

**SOT-89**

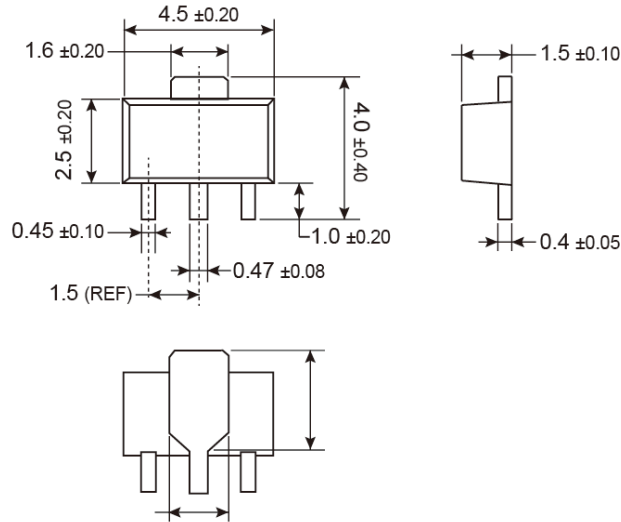

**SUGGESTED PAD LAYOUT** (Unit: Millimeters)

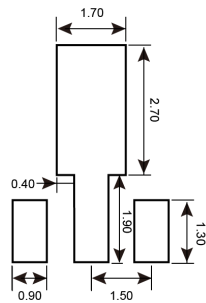

**MARKING DIAGRAM**

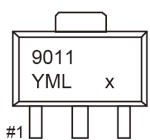

- Y** = Year Code
- M** = Month Code for Halogen Free Product
  - O** =Jan    **P** =Feb    **Q** =Mar    **R** =Apr
  - S** =May    **T** =Jun    **U** =Jul    **V** =Aug
  - W** =Sep    **X** =Oct    **Y** =Nov    **Z** =Dec
- L** = Lot Code (1~9, A~Z)
- X** = Fixed Output Voltage Code
  - A**=1.5V, **D**=1.8V, **K**=2.5V, **P**=3.0V, **S**=3.3V, **5**=5.0V.

## Notice

Specifications of the products displayed herein are subject to change without notice. TSC or anyone on its behalf, assumes no responsibility or liability for any errors or inaccuracies.

Information contained herein is intended to provide a product description only. No license, express or implied, to any intellectual property rights is granted by this document. Except as provided in TSC's terms and conditions of sale for such products, TSC assumes no liability whatsoever, and disclaims any express or implied warranty, relating to sale and/or use of TSC products including liability or warranties relating to fitness for a particular purpose, merchantability, or infringement of any patent, copyright, or other intellectual property right.

The products shown herein are not designed for use in medical, life-saving, or life-sustaining applications. Customers using or selling these products for use in such applications do so at their own risk and agree to fully indemnify TSC for any damages resulting from such improper use or sale.

# Mouser Electronics

Authorized Distributor

Click to View Pricing, Inventory, Delivery & Lifecycle Information:

## Taiwan Semiconductor:

[TS90115CX](#) [TS90115CY](#) [TS9011DCX](#) [TS9011DCY](#) [TS9011KCX](#) [TS9011SCX](#) [TS9011SCY](#) [TS9011KCY RMG](#)  
[TS9011PCY RMG](#) [TS90115CY RMG](#) [TS9011KCX RFG](#) [TS9011DCY RMG](#) [TS9011DCX RFG](#) [TS9011SCY RMG](#)  
[TS9011SCX RFG](#) [TS90115CX RFG](#)