

Typical Applications Circuit

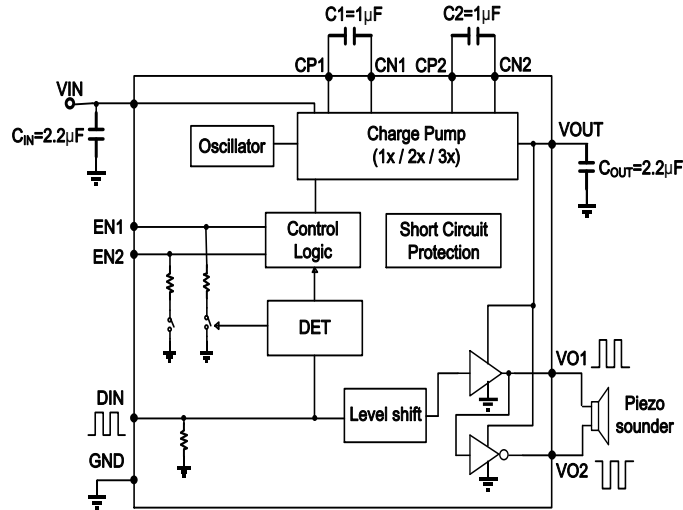

Pin Descriptions

Pin Number		Pin Name	I/O/P	Function
U-QFN3030-16 (Type B)	U-QFN3030-12 (Type A)			
1	1	EN1	I	Charge pump mode select 1
2	2	EN2	I	Charge pump mode select 2
3	3	DIN	I	Signal Input
4	—	NC	—	No Connection
5	4	CN1	I	Capacitor 1 Negative Terminal
6	5	GND	P	Ground
7	6	VO2	O	Positive Output
8	—	NC	—	No Connection
9	7	VO1	O	Negative Output
10	8	CN2	I	Capacitor 2 Negative Terminal
11	9	CP1	I	Capacitor 1 Positive Terminal
12	—	NC	—	No Connection
13	10	VOOUT	O	Boost Output
14	11	CP2	I	Capacitor 2 Positive Terminal
15	12	VIN	P	Power Supply
16	—	NC	—	No Connection

Absolute Maximum Ratings (@ $T_A = +25^\circ\text{C}$, unless otherwise specified.)

Symbol	Characteristics	Value	Unit
V_{IN}	Supply Voltage	-0.3 to +6.0	V
V_{OUT}	Output Voltage	15	V
V_{EN1}, V_{EN2}	EN1, EN2 Voltage	GND -0.3 to $V_{IN} + 0.3$	V
T_A	Operating Free-Air Temperature Range	-40 to +85	$^\circ\text{C}$
T_J	Operating Junction Temperature Range	-40 to +150	$^\circ\text{C}$
T_{STG}	Storage Temperature Range	-65 to +150	$^\circ\text{C}$

Recommended Operating Conditions (@ $T_A = +25^\circ\text{C}$, unless otherwise specified.)

Symbol	Characteristics	Min	Max	Unit	
V_{IN}	Supply Voltage	—	2.3	5.5	V
V_{IH}	High-Level Input Voltage	EN1, EN2	1.2 to $V_{IN} + 0.3$		V
V_{IL}	Low-Level Input Voltage	EN1, EN2	-0.3	+0.4	V
T_A	Operating Free-Air Temperature	-40	+85	$^\circ\text{C}$	

Thermal Information

Parameter	Symbol	Package	Maximum	Unit
Thermal Resistance (Junction to Ambient)	θ_{JA}	U-QFN3030-16 (Type B) U-QFN3030-12 (Type A)	35	$^\circ\text{C/W}$
Thermal Resistance (Junction to Case)	θ_{JC}	U-QFN3030-16 (Type B) U-QFN3030-12 (Type A)	14	$^\circ\text{C/W}$

Electrical Characteristics (@ $T_A = +25^\circ\text{C}$, $V_{IN} = 3.0\text{V}$, $C_{PIEZO} = 15\text{nF}$, $f_{DIN} = 4\text{kHz}$, unless otherwise specified.)

Parameter	Symbol	Conditions	Min	Typ	Max	Unit
Output Voltage Range	V_{OUT}	(Note 4)	2.1	—	12	V
Output Voltage	V_{OUT1}	1x Mode	2.8	—	3	V
	V_{OUT2}	2x Mode	5.2	—	6	V
	V_{OUT3}	3x Mode (Note 5)	7.2	—	9	V
Operating Current 1	I_{DD11}	1x Mode, $C_{PIEZO} = \text{No Load}$	—	50	—	μA
	I_{DD12}	2x Mode, $C_{PIEZO} = \text{No Load}$	—	720	—	μA
	I_{DD13}	3x Mode, $C_{PIEZO} = \text{No Load}$	—	1,700	—	μA
Operating Current 2	I_{DD21}	1x Mode, Single-ended application	—	0.3	—	mA
	I_{DD22}	2x Mode, Single-ended application	—	1.4	—	mA
	I_{DD23}	3x Mode, Single-ended application	—	3.9	—	mA
Operating Current 3	I_{DD31}	1x Mode, Differential application	—	0.9	—	mA
	I_{DD32}	2x Mode, Differential application	—	3.6	—	mA
	I_{DD33}	3x Mode, Differential application	—	7.9	—	mA
Shutdown Current	I_{SD}	$DIN = 0\text{V}$	—	—	1	μA
Input Frequency	f_{IN}	Rectangular pulse	—	4	—	kHz
Oscillating Frequency	f_{OSC}	—	—	1	—	MHz
VOUT Start Delay Time	t_{ON1}	1x Mode, From DIN signal High to 90% V_{OUT} steady state	—	270	—	μs
	t_{ON2}	2x Mode, From DIN signal High to 90% V_{OUT} steady state	—	320	—	μs
	t_{ON3}	3x Mode From DIN signal High to 90% V_{OUT} steady state	—	350	—	μs
Shutdown Delay Time	t_{OFF}	$DIN = H \rightarrow L$	—	42	—	ms
Output Short-Circuit Current	I_{SC}	—	—	40	—	mA
Control Terminal Voltage H	V_{IH}	EN1, EN2, DIN pins	$0.8 \cdot V_{IN}$	—	V_{IN}	V
Control Terminal Voltage L	V_{IL}	EN1, EN2, DIN pins	0	—	$0.2 \cdot V_{IN}$	V
Control Terminal Current 1	I_{IH1}	$DIN = 3\text{V}$	—	—	1	μA
Control Terminal Current 2	I_{IH2}	$V_{EN1}, V_{EN2} = 3\text{V}, DIN = 3\text{V}$	—	—	1	μA
Control Terminal Current 3	I_{IH3}	$V_{EN1}, V_{EN2} = 3\text{V}, DIN = 0\text{V}$	—	—	1	μA

- Notes:
- It is possible to drive V_{OUT} , $VO1$ and $VO2$ to $3x V_{DD}$. A supply voltage of 4V or more should not be used in 3x mode as this will exceed the maximum output voltage rating.
 - When designed under 3x mode, it should be carefully noted that the V_{OUT} absolute maximum value should not exceed 15V.

Application Information

Charge Pump Mode Setting

The Charge Pump Mode (CPM) pins EN1 and EN2 are used to set the charge pump into mode 1x V_{DD}, 2x V_{DD}, 3x V_{DD} or they can be used to put the PAM8904 in to a forced low current shutdown mode.

DIN	EN1	EN2	MODE
0	—	—	Shutdown Mode
1	0	0	Shutdown Mode
1	0	1	1x Mode
1	1	0	2x Mode
1	1	1	3x Mode

Care must be taken when using the 3x mode with a V_{DD} supply of 5V or more, as this will force the V_{OUT} to exceed its Absolute Maximum specification (15V).

V _{DD} Range	Mode
2.3V to 5.5V	1x, 2x and 3x

Timing Chart and Device Operation

When one or both of the EN pins are pulled high, the device enters normal operation mode, refer to the above table for the mode selection. Once the PAM8904 senses a valid signal on the DIN pin, the charge pump will start and provide the desired voltage on the V_{OUT} pin and the output drive VO1 and VO2 start to function after time t_{ON} which is typically between 270µs and 350µs depending on the mode chosen. Once the input signal on DIN is removed, the PAM8904 senses this and waits typically 42ms to ensure the signal has been removed. If there is no further valid signal within the time period t_{OFF}, the PAM8904 enters into a low current standby mode.

Timing Chart

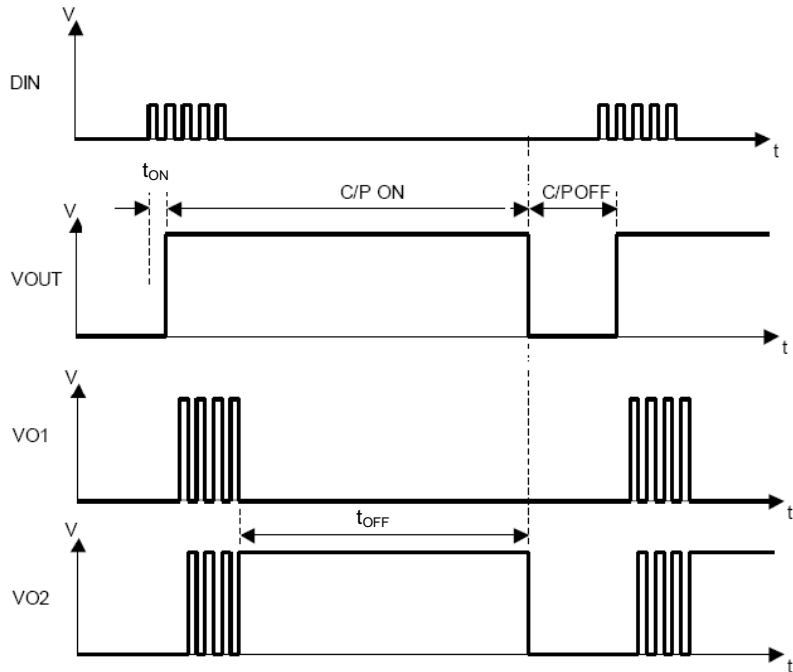

Application Information (continued)

Output Configuration

The PAM8904 is able to be configured either in a differential or a single ended configuration.

Short-Circuit Protection

The PAM8904 has short circuit protection circuitry on the outputs to prevent damage. Once a short circuit is detected on the outputs the chip will limit the total current to protect the output device. This is not a latched fault; once the short is removed the normal operation is restored.

Thermal Protection

If the junction temperature of the PAM8904 exceeds +150°C the device will enter overtemperature shutdown. The outputs and the charge pump will be switched off. Once the junction temperature cools down to its normal operating condition, the IC will re-start automatically.

Ordering Information

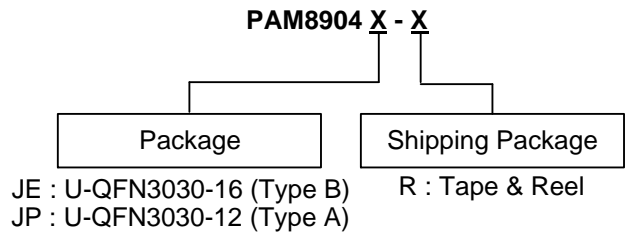

Part Number	Package Type	Shipping
PAM8904JER	U-QFN3030-16 (Type B)	3,000/Tape & Reel
PAM8904JPR	U-QFN3030-12 (Type A)	3,000/Tape & Reel

Marking Information

U-QFN3030-16 (Type B) / U-QFN3030-12 (Type A)

(Top View)

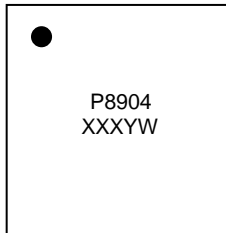

P8904: Product Code
 XXX: Internal Code
 Y: Year 0-9
 W: Week: A-Z: 1~26 weeks;
 a-z: 27~52 weeks;
 z represents 52 and 53 weeks

Package Outline Dimensions

Please see <http://www.diodes.com/package-outlines.html> for the latest version.

(1) Package Type: U-QFN3030-16 (Type B)

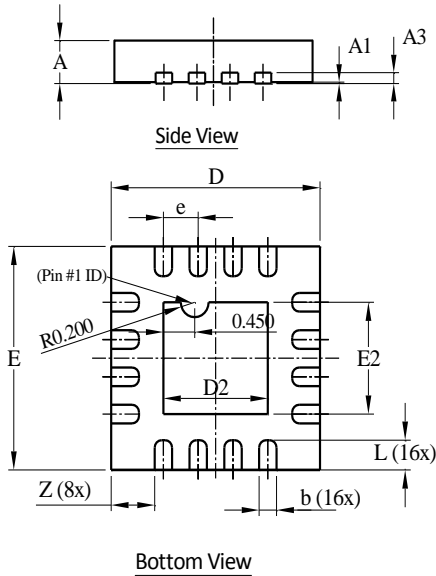

U-QFN3030-16 Type B			
Dim	Min	Max	Typ
A	0.55	0.65	0.60
A1	0	0.05	0.02
A3	-	-	0.15
b	0.18	0.28	0.23
D	2.95	3.05	3.00
D2	1.40	1.60	1.50
E	2.95	3.05	3.00
E2	1.40	1.60	1.50
e	-	-	0.50
L	0.35	0.45	0.40
Z	-	-	0.625
All Dimensions in mm			

(2) Package Type: U-QFN3030-12 (Type A)

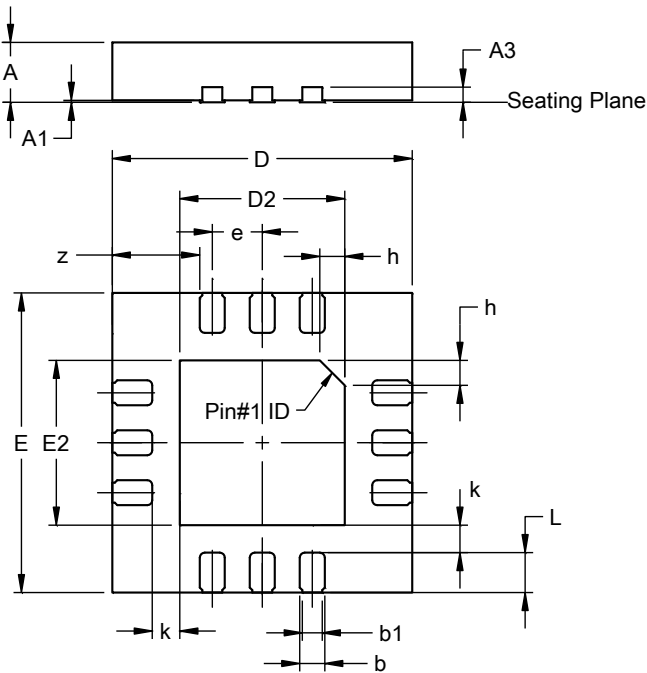

U-QFN3030-12 (Type A)			
Dim	Min	Max	Typ
A	0.55	0.65	0.60
A1	0.00	0.05	0.02
A3	--	--	0.152
b	0.20	0.35	0.25
b1	0.15	0.25	0.20
D	2.95	3.05	3.00
D2	1.55	1.75	1.65
E	2.95	3.05	3.00
E2	1.55	1.75	1.65
e	--	--	0.50
h	--	--	0.25
L	0.35	0.45	0.40
k	--	--	0.275
z	--	--	0.875
All Dimensions in mm			

Suggested Pad Layout

Please see <http://www.diodes.com/package-outlines.html> for the latest version.

(1) Package Type: U-QFN3030-16 (Type B)

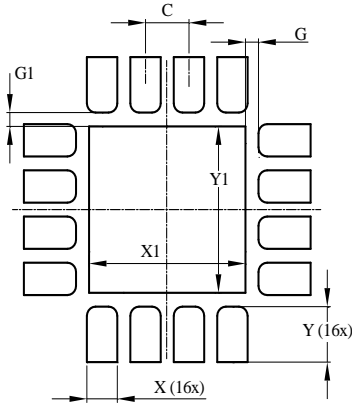

Dimensions	Value (in mm)
C	0.500
G	0.150
G1	0.150
X	0.350
X1	1.800
Y	0.600
Y1	1.800

(2) Package Type: U-QFN3030-12 (Type A)

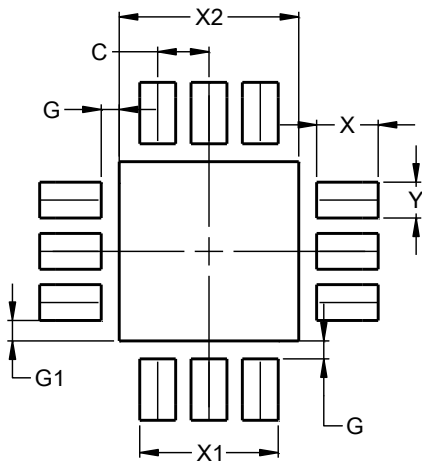

Dimensions	Value (in mm)
C	0.500
G	0.175
G1	0.200
X	0.600
X1	1.350
X2	1.750
Y	0.350
Y1	1.750

IMPORTANT NOTICE

DIODES INCORPORATED MAKES NO WARRANTY OF ANY KIND, EXPRESS OR IMPLIED, WITH REGARDS TO THIS DOCUMENT, INCLUDING, BUT NOT LIMITED TO, THE IMPLIED WARRANTIES OF MERCHANTABILITY AND FITNESS FOR A PARTICULAR PURPOSE (AND THEIR EQUIVALENTS UNDER THE LAWS OF ANY JURISDICTION).

Diodes Incorporated and its subsidiaries reserve the right to make modifications, enhancements, improvements, corrections or other changes without further notice to this document and any product described herein. Diodes Incorporated does not assume any liability arising out of the application or use of this document or any product described herein; neither does Diodes Incorporated convey any license under its patent or trademark rights, nor the rights of others. Any Customer or user of this document or products described herein in such applications shall assume all risks of such use and will agree to hold Diodes Incorporated and all the companies whose products are represented on Diodes Incorporated website, harmless against all damages.

Diodes Incorporated does not warrant or accept any liability whatsoever in respect of any products purchased through unauthorized sales channel. Should Customers purchase or use Diodes Incorporated products for any unintended or unauthorized application, Customers shall indemnify and hold Diodes Incorporated and its representatives harmless against all claims, damages, expenses, and attorney fees arising out of, directly or indirectly, any claim of personal injury or death associated with such unintended or unauthorized application.

Products described herein may be covered by one or more United States, international or foreign patents pending. Product names and markings noted herein may also be covered by one or more United States, international or foreign trademarks.

This document is written in English but may be translated into multiple languages for reference. Only the English version of this document is the final and determinative format released by Diodes Incorporated.

LIFE SUPPORT

Diodes Incorporated products are specifically not authorized for use as critical components in life support devices or systems without the express written approval of the Chief Executive Officer of Diodes Incorporated. As used herein:

A. Life support devices or systems are devices or systems which:

1. are intended to implant into the body, or
2. support or sustain life and whose failure to perform when properly used in accordance with instructions for use provided in the labeling can be reasonably expected to result in significant injury to the user.

B. A critical component is any component in a life support device or system whose failure to perform can be reasonably expected to cause the failure of the life support device or to affect its safety or effectiveness.

Customers represent that they have all necessary expertise in the safety and regulatory ramifications of their life support devices or systems, and acknowledge and agree that they are solely responsible for all legal, regulatory and safety-related requirements concerning their products and any use of Diodes Incorporated products in such safety-critical, life support devices or systems, notwithstanding any devices- or systems-related information or support that may be provided by Diodes Incorporated. Further, Customers must fully indemnify Diodes Incorporated and its representatives against any damages arising out of the use of Diodes Incorporated products in such safety-critical, life support devices or systems.

Copyright © 2020, Diodes Incorporated

www.diodes.com

Mouser Electronics

Authorized Distributor

Click to View Pricing, Inventory, Delivery & Lifecycle Information:

[Diodes Incorporated:](#)

[PAM8904JER](#) [PAM8904JPR](#)