

Table 3. Electrical Characteristics ($T_C = 25^\circ\text{C}$ unless otherwise noted)

Characteristic	Symbol	Min	Typ	Max	Unit
Off Characteristics					
Drain-Source Breakdown Voltage ($V_{GS} = 0\text{ Vdc}$, $I_D = 20\ \mu\text{Adc}$)	$V_{(BR)DSS}$	65	—	—	Vdc
Zero Gate Voltage Drain Current ($V_{DS} = 28\text{ Vdc}$, $V_{GS} = 0\text{ Vdc}$)	I_{DSS}	—	—	10	μAdc
Gate-Source Leakage Current ($V_{GS} = 20\text{ Vdc}$, $V_{DS} = 0\text{ Vdc}$)	I_{GSS}	—	—	1	μAdc
On Characteristics					
Gate Threshold Voltage ($V_{DS} = 10\text{ Vdc}$, $I_D = 300\ \mu\text{Adc}$)	$V_{GS(th)}$	2	3	4	Vdc
Gate Quiescent Voltage ($V_{DS} = 26\text{ Vdc}$, $I_D = 400\ \text{mAdc}$)	$V_{GS(Q)}$	3	4	5	Vdc
Drain-Source On-Voltage ($V_{GS} = 10\text{ Vdc}$, $I_D = 1\text{ Adc}$)	$V_{DS(on)}$	—	0.15	0.6	Vdc
Forward Transconductance ($V_{DS} = 10\text{ Vdc}$, $I_D = 2\text{ Adc}$)	g_{fs}	2	3	—	S
Dynamic Characteristics					
Input Capacitance (1) ($V_{DS} = 26\text{ Vdc}$, $V_{GS} = 0$, $f = 1\text{ MHz}$)	C_{iss}	—	130	—	pF
Output Capacitance ($V_{DS} = 26\text{ Vdc}$, $V_{GS} = 0$, $f = 1\text{ MHz}$)	C_{oss}	41	47	52	pF
Reverse Transfer Capacitance ($V_{DS} = 26\text{ Vdc}$, $V_{GS} = 0$, $f = 1\text{ MHz}$)	C_{rss}	2.4	3	3.4	pF
Functional Tests (In Freescale Test Fixture)					
Output Power ($V_{DD} = 26\text{ Vdc}$, $I_{DQ} = 400\text{ mA}$, $f = 940\text{ MHz}$)	P1dB	73	80	—	W
Common-Source Amplifier Power Gain @ P1dB (Min) ($V_{DD} = 26\text{ Vdc}$, $I_{DQ} = 400\text{ mA}$, $f = 940\text{ MHz}$)	G_{ps}	14	16	18	dB
Drain Efficiency @ $P_{out} = 50\text{ W}$ ($V_{DD} = 26\text{ Vdc}$, $I_{DQ} = 400\text{ mA}$, $f = 940\text{ MHz}$)	η_1	47	51	—	%
Drain Efficiency @ P1dB ($V_{DD} = 26\text{ Vdc}$, $I_{DQ} = 400\text{ mA}$, $f = 940\text{ MHz}$)	η_2	—	58	—	%
Input Return Loss @ $P_{out} = 50\text{ W}$ ($V_{DD} = 26\text{ Vdc}$, $I_{DQ} = 400\text{ mA}$, $f = 940\text{ MHz}$)	IRL	—	—	-15	dB

1. Value excludes the input matching.

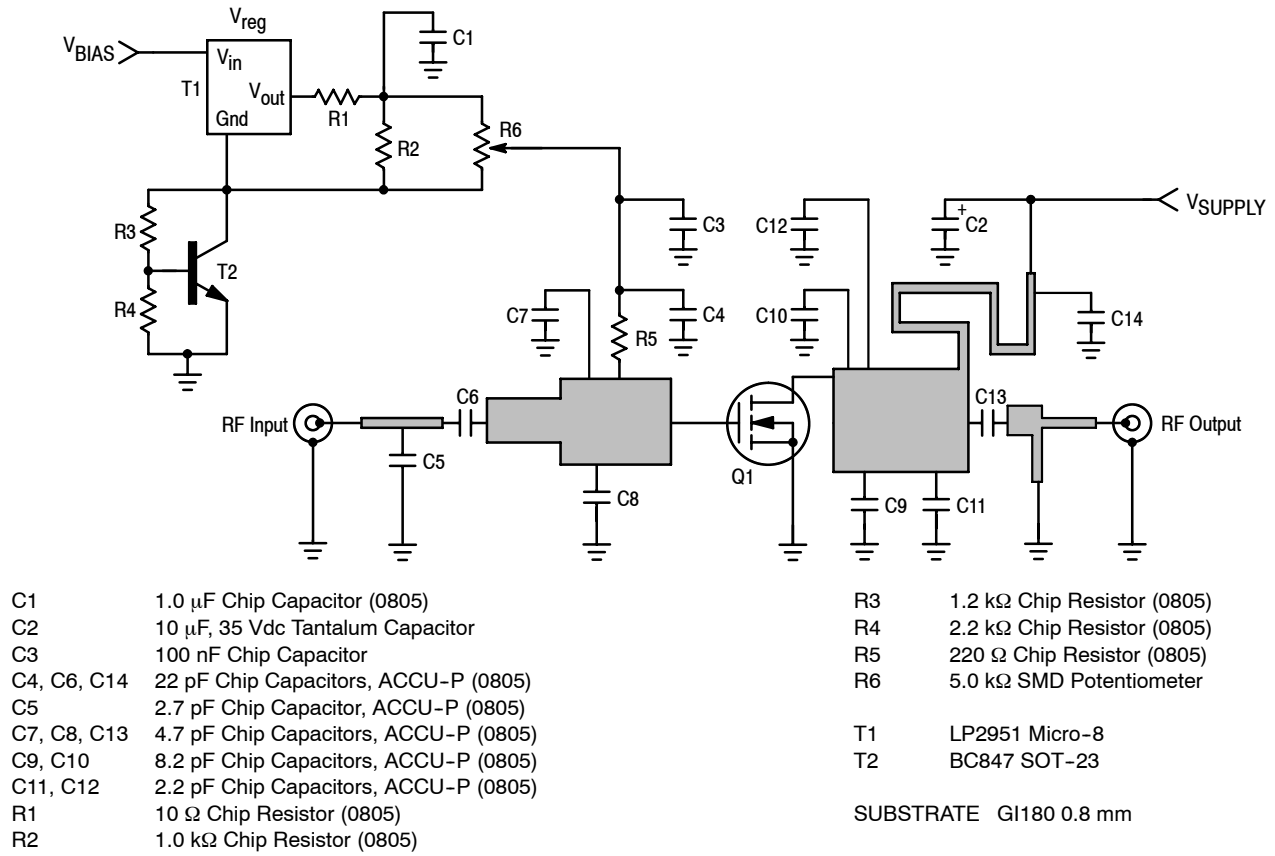
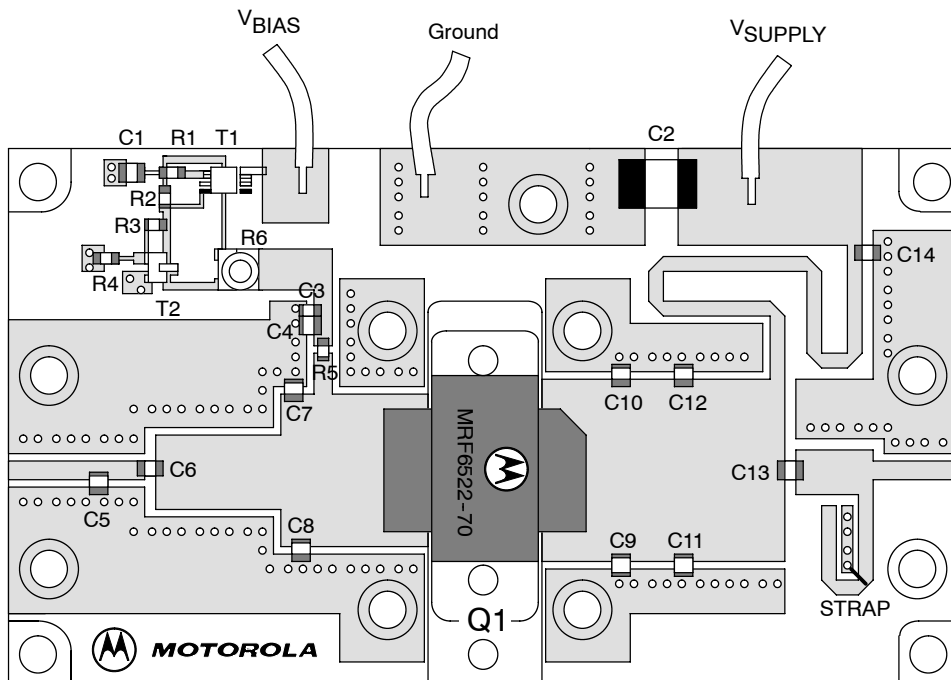

Figure 1. MRF6522-70 Test Circuit Schematic



Freescale has begun the transition of marking Printed Circuit Boards (PCBs) with the Freescale Semiconductor signature/logo. PCBs may have either Motorola or Freescale markings during the transition period. These changes will have no impact on form, fit or function of the current product.

Figure 2. MRF6522-70 Test Circuit Component Layout

TYPICAL CHARACTERISTICS

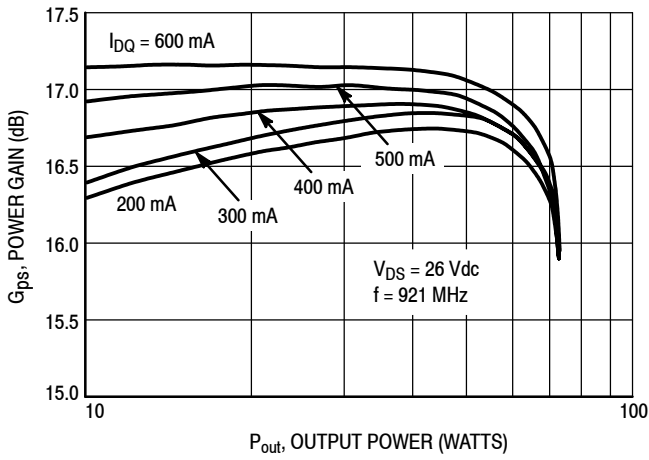

Figure 3. Power Gain versus Output Power

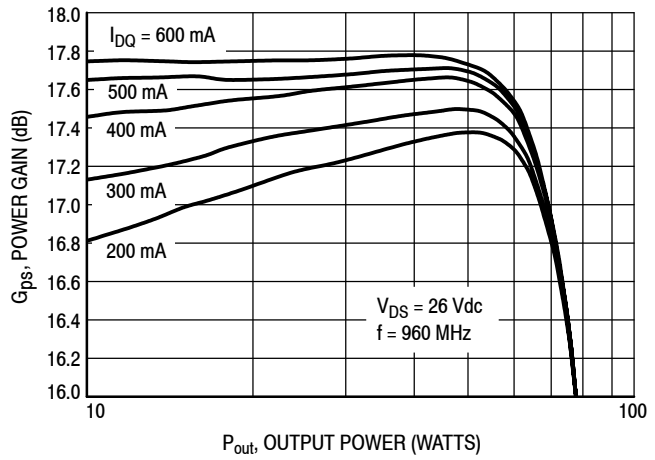

Figure 4. Power Gain versus Output Power

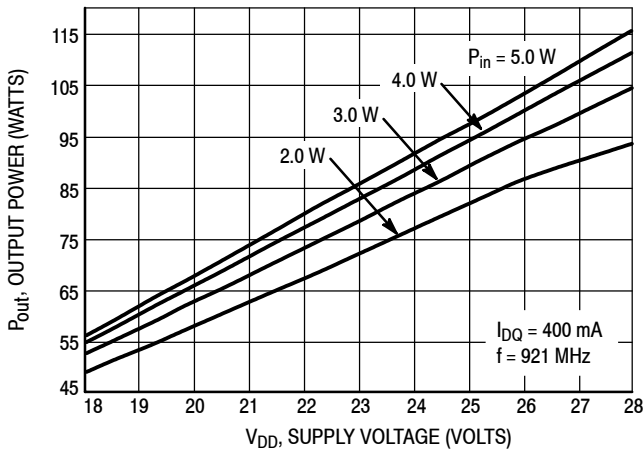

Figure 5. Output Power versus Supply Voltage

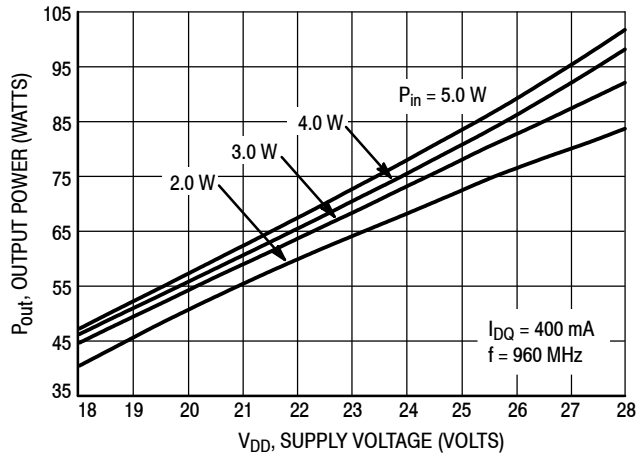

Figure 6. Output Power versus Supply Voltage

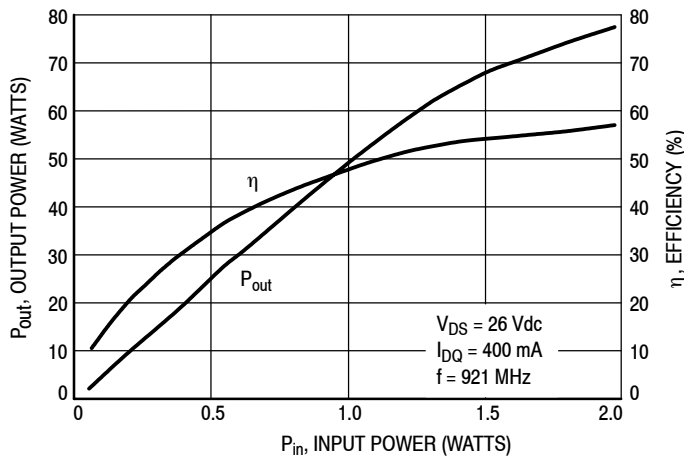

Figure 7. Efficiency and Output Power versus Input Power

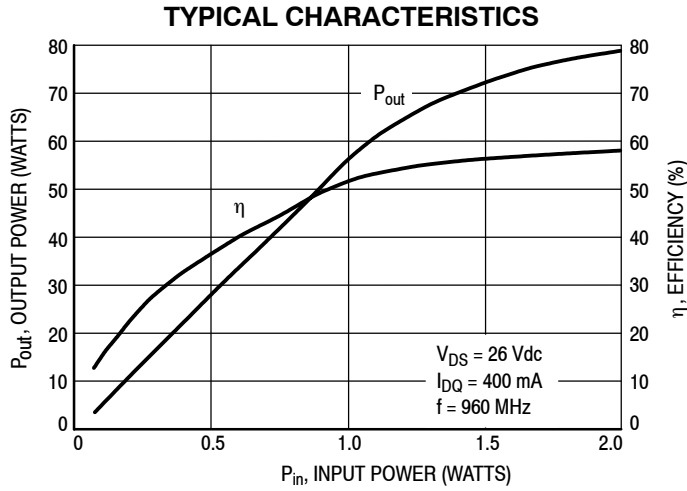

Figure 8. Efficiency and Output Power versus Input Power

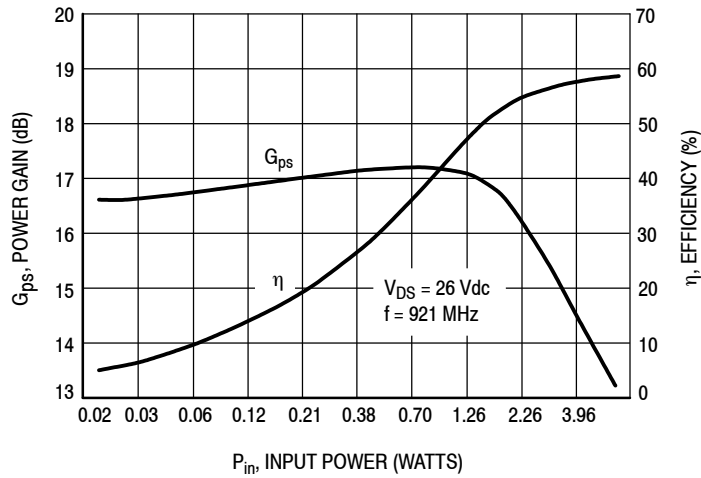

Figure 9. Power Gain and Efficiency versus Input Power

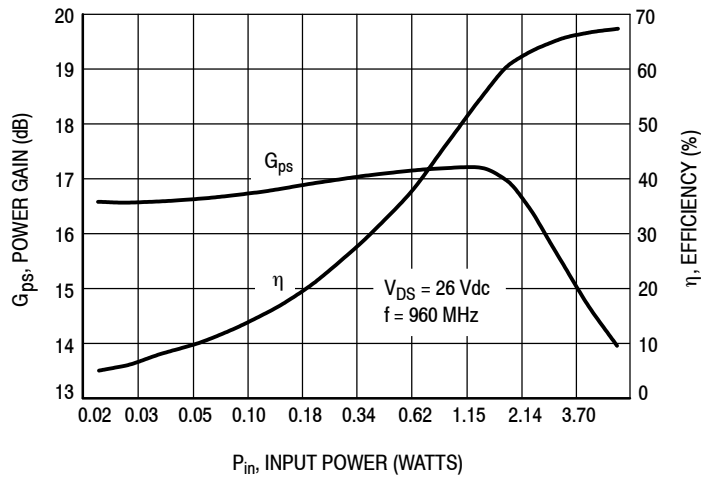

Figure 10. Power Gain and Efficiency versus Input Power

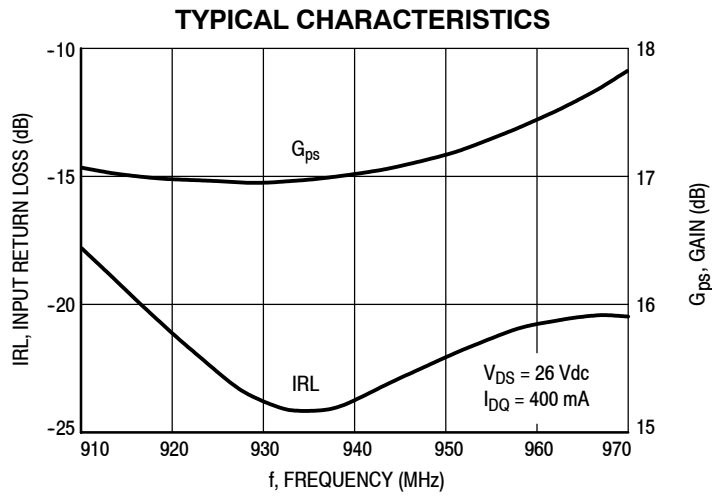
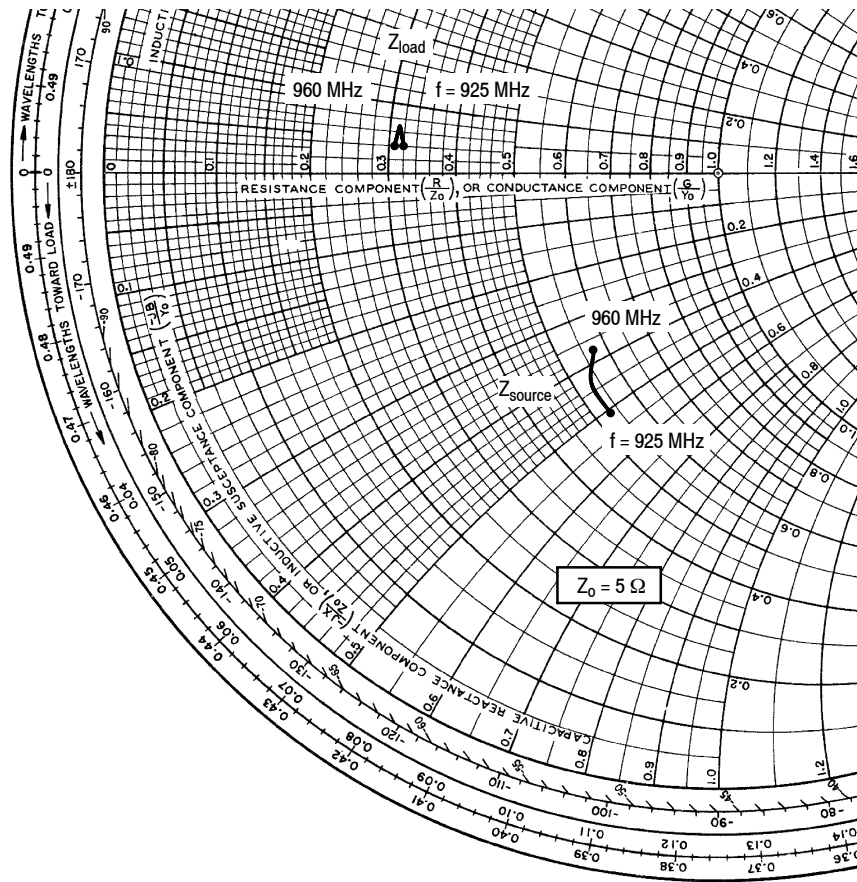

Figure 11. Performance in Broadband Circuit (at Small Signal)



$V_{SUPPLY} = 26 \text{ Vdc}$, $I_{BIAS} = 400 \text{ mA}$, $CW = \text{Room Temperature}$

f MHz	Z_{source} Ω	Z_{load} Ω
925	$2.65 - j2.53$	$1.62 + j0.2$
940	$2.67 - j2.14$	$1.56 + j0.34$
960	$2.85 - j1.87$	$1.55 + j0.2$

Z_{source} = Test circuit impedance as measured from gate to ground.

Z_{load} = Test circuit impedance as measured from drain to ground.

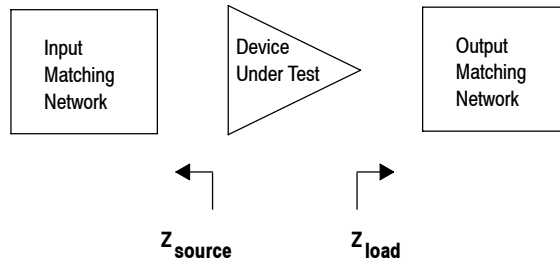
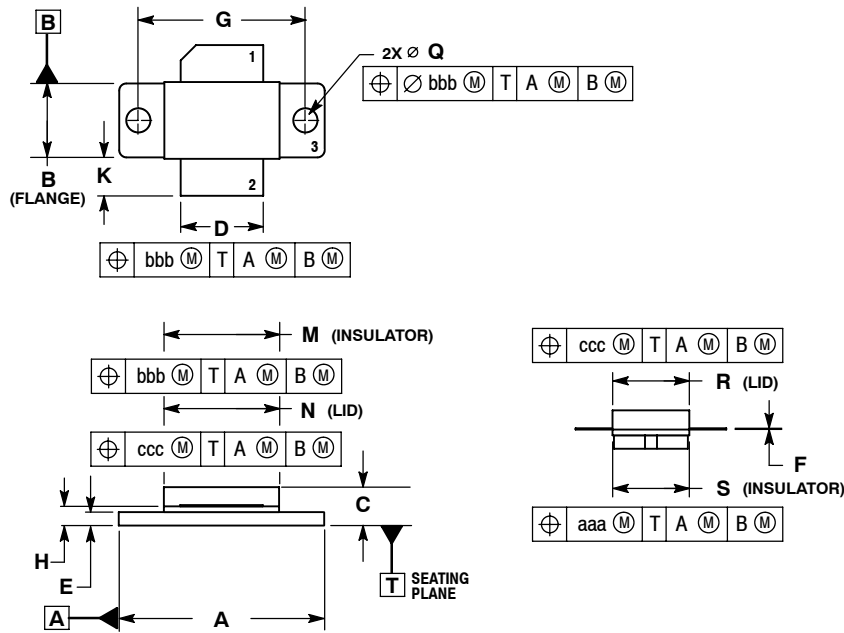

Figure 12. Series Equivalent Source and Load Impedance

PACKAGE DIMENSIONS



- NOTES:
1. INTERPRET DIMENSIONS AND TOLERANCES PER ANSI Y14.5M-1994.
 2. CONTROLLING DIMENSION: INCH.
 3. DIMENSION H IS MEASURED 0.030 (0.762) AWAY FROM PACKAGE BODY.

DIM	INCHES		MILLIMETERS	
	MIN	MAX	MIN	MAX
A	1.065	1.075	27.05	27.30
B	0.380	0.390	9.65	9.91
C	0.160	0.205	4.06	5.21
D	0.425	0.435	10.80	11.05
E	0.060	0.070	1.52	1.78
F	0.004	0.006	0.10	0.15
G	0.870 BSC		22.10 BSC	
H	0.096	0.106	2.44	2.69
K	0.190	0.223	4.83	5.66
M	0.594	0.606	15.09	15.39
N	0.591	0.601	15.01	15.27
Q	0.124	0.130	3.15	3.30
R	0.394	0.404	10.01	10.26
S	0.395	0.405	10.03	10.29
aaa	0.005 REF		0.13 REF	
bbb	0.010 REF		0.25 REF	
ccc	0.015 REF		0.38 REF	

- STYLE 1:
 PIN 1. DRAIN
 2. GATE
 3. SOURCE

**CASE 465D-05
 ISSUE D
 NI-600**

PRODUCT DOCUMENTATION

Refer to the following documents to aid your design process.

Engineering Bulletins

- EB212: Using Data Sheet Impedances for RF LDMOS Devices

REVISION HISTORY

The following table summarizes revisions to this document.

Revision	Date	Description
9	Oct. 2008	<ul style="list-style-type: none">• Modified data sheet to reflect RF Test Reduction described in Product and Process Change Notification number, PCN12779, p. 1, 2• Added Product Documentation and Revision History, p. 9
	Dec. 2010	<ul style="list-style-type: none">• Data sheet archived. Part no longer manufactured.

ARCHIVE INFORMATION

ARCHIVE INFORMATION

How to Reach Us:

Home Page:

www.freescale.com

Web Support:

<http://www.freescale.com/support>

USA/Europe or Locations Not Listed:

Freescale Semiconductor, Inc.
Technical Information Center, EL516
2100 East Elliot Road
Tempe, Arizona 85284
1-800-521-6274 or +1-480-768-2130
www.freescale.com/support

Europe, Middle East, and Africa:

Freescale Halbleiter Deutschland GmbH
Technical Information Center
Schatzbogen 7
81829 Muenchen, Germany
+44 1296 380 456 (English)
+46 8 52200080 (English)
+49 89 92103 559 (German)
+33 1 69 35 48 48 (French)
www.freescale.com/support

Japan:

Freescale Semiconductor Japan Ltd.
Headquarters
ARCO Tower 15F
1-8-1, Shimo-Meguro, Meguro-ku,
Tokyo 153-0064
Japan
0120 191014 or +81 3 5437 9125
support.japan@freescale.com

Asia/Pacific:

Freescale Semiconductor China Ltd.
Exchange Building 23F
No. 118 Jianguo Road
Chaoyang District
Beijing 100022
China
+86 10 5879 8000
support.asia@freescale.com

For Literature Requests Only:

Freescale Semiconductor Literature Distribution Center
P.O. Box 5405
Denver, Colorado 80217
1-800-441-2447 or +1-303-675-2140
Fax: +1-303-675-2150
LDCForFreescaleSemiconductor@hibbertgroup.com

Information in this document is provided solely to enable system and software implementers to use Freescale Semiconductor products. There are no express or implied copyright licenses granted hereunder to design or fabricate any integrated circuits or integrated circuits based on the information in this document.

Freescale Semiconductor reserves the right to make changes without further notice to any products herein. Freescale Semiconductor makes no warranty, representation or guarantee regarding the suitability of its products for any particular purpose, nor does Freescale Semiconductor assume any liability arising out of the application or use of any product or circuit, and specifically disclaims any and all liability, including without limitation consequential or incidental damages. "Typical" parameters that may be provided in Freescale Semiconductor data sheets and/or specifications can and do vary in different applications and actual performance may vary over time. All operating parameters, including "Typicals", must be validated for each customer application by customer's technical experts. Freescale Semiconductor does not convey any license under its patent rights nor the rights of others. Freescale Semiconductor products are not designed, intended, or authorized for use as components in systems intended for surgical implant into the body, or other applications intended to support or sustain life, or for any other application in which the failure of the Freescale Semiconductor product could create a situation where personal injury or death may occur. Should Buyer purchase or use Freescale Semiconductor products for any such unintended or unauthorized application, Buyer shall indemnify and hold Freescale Semiconductor and its officers, employees, subsidiaries, affiliates, and distributors harmless against all claims, costs, damages, and expenses, and reasonable attorney fees arising out of, directly or indirectly, any claim of personal injury or death associated with such unintended or unauthorized use, even if such claim alleges that Freescale Semiconductor was negligent regarding the design or manufacture of the part.

Freescale™ and the Freescale logo are trademarks of Freescale Semiconductor, Inc. All other product or service names are the property of their respective owners.

© Freescale Semiconductor, Inc. 2008, 2010. All rights reserved.

