

Ordering Information

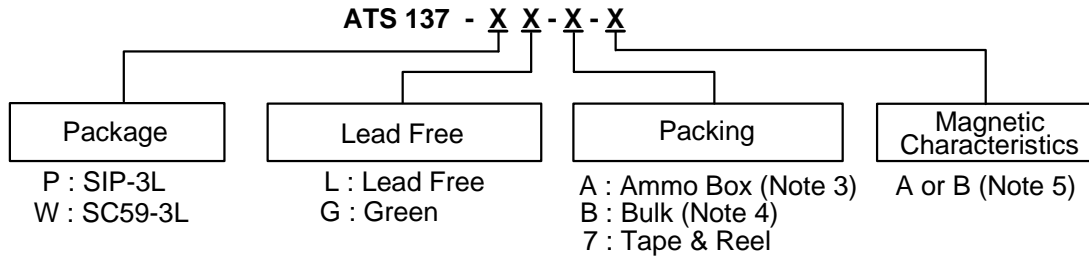

Device	Package Code	Packaging (Note 2)	Bulk		7" Tape and Reel		Ammo Box		Magnetic Characteristics (Note 5)
			Quantity	Part Number Suffix	Quantity	Part Number Suffix	Quantity	Part Number Suffix	
ATS137-PL-A-A	P	SIP-3L	NA	NA	NA	NA	4000/Box	-A	A
ATS137-PL-A-B	P	SIP-3L	NA	NA	NA	NA	4000/Box	-A	B
ATS137-PL-B-A	P	SIP-3L	1000	-B	NA	NA	NA	NA	A
ATS137-PL-B-B	P	SIP-3L	1000	-B	NA	NA	NA	NA	B
ATS137-PG-A-A	P	SIP-3L	NA	NA	NA	NA	4000/Box	-A	A
ATS137-PG-A-B	P	SIP-3L	NA	NA	NA	NA	4000/Box	-A	B
ATS137-PG-B-A	P	SIP-3L	1000	-B	NA	NA	NA	NA	A
ATS137-PG-B-B	P	SIP-3L	1000	-B	NA	NA	NA	NA	B
ATS137-WL-7-A	W	SC59-3L	NA	NA	3000/Tape & Reel	-7	NA	NA	A
ATS137-WG-7-A	W	SC59-3L	NA	NA	3000/Tape & Reel	-7	NA	NA	A

- Notes:
1. EU Directive 2002/95/EC (RoHS). All applicable RoHS exemptions applied. Please visit our website at http://www.diodes.com/products/lead_free.html
 2. Pad layout as shown on Diodes Inc. suggested pad layout document AP02001, which can be found on our website at <http://www.diodes.com/datasheets/ap02001.pdf>.
 3. Ammo Box is for SIP-3L Spread Lead.
 4. Bulk is for SIP-3L Straight Lead.
 5. Please refer the Magnetic Characteristics table, B is available in SIP-3L package only.

Pin Assignment

(1) SIP-3L

(Top View)

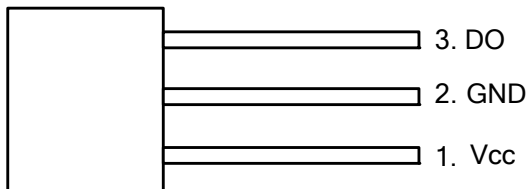

(2) SC59-3L

(Top View)

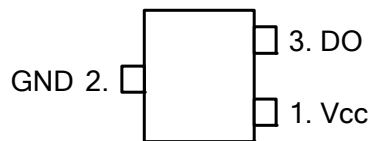

Pin Descriptions

Pin Name	Pin #	Description
V _{CC}	1	Positive Power Supply
GND	2	Ground
DO	3	Digital Output

Functional Block Diagrams

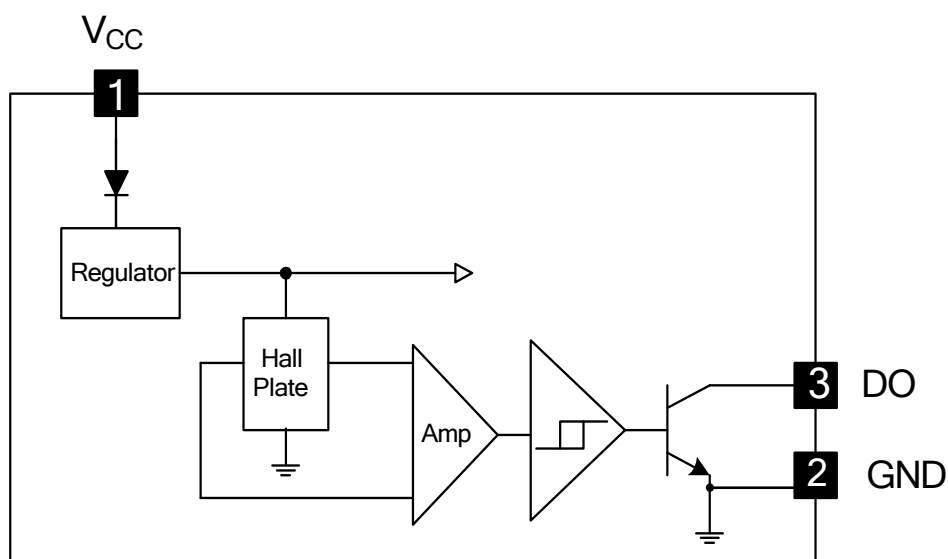

Absolute Maximum Ratings (T_A = 25°C)

Symbol	Characteristics		Values	Unit
V _{CC}	Supply Voltage		20	V
V _{RCC}	Reverse V _{CC} Polarity Voltage		-20	V
B	Magnetic Flux Density		Unlimited	
V _{ce}	Output "OFF" Voltage		30	V
I _C	Output "ON" Current	Continuous	25	mA
T _{ST}	Storage Temperature		-65~+150	°C
T _{J(MAX)}	Maximum Junction Temperature		150	°C
P _D	Package Power Dissipation	SIP-3L	550	mW
		SC59-3L	230	mW

Recommended Operating Conditions

Symbol	Characteristic	Conditions	Min	Max	Unit
V_{CC}	Supply Voltage	Operating	3.5	20	V
T_A	Operating Ambient Temperature	Operating	-20	85	°C

Electrical Characteristics ($T_A = +25^\circ\text{C}$)

Symbol	Characteristic	Test Conditions	Min	Typ.	Max	Unit
$V_{ce(SAT)}$	Output Saturation Voltage	$V_{CC} = 14\text{V}, I_{CC} = 20\text{mA}$	-	300	700	mV
I_{ceX}	Output Leakage Current	$V_{ce} = 14\text{V}, V_{CC} = 14\text{V}$	-	<0.1	10	uA
I_{CC}	Supply Current	$V_{CC} = 20\text{V}, \text{Output Open}$	-	5	10	mA
t_r	Output Rise Time	$V_{CC} = 14\text{V}, R_L = 820\Omega, CL = 20\text{pF}$	-	0.3	1.5	us
t_f	Output Falling Time	$V_{CC} = 14\text{V}, R_L = 820\Omega, CL = 20\text{pF}$	-	0.3	1.5	us

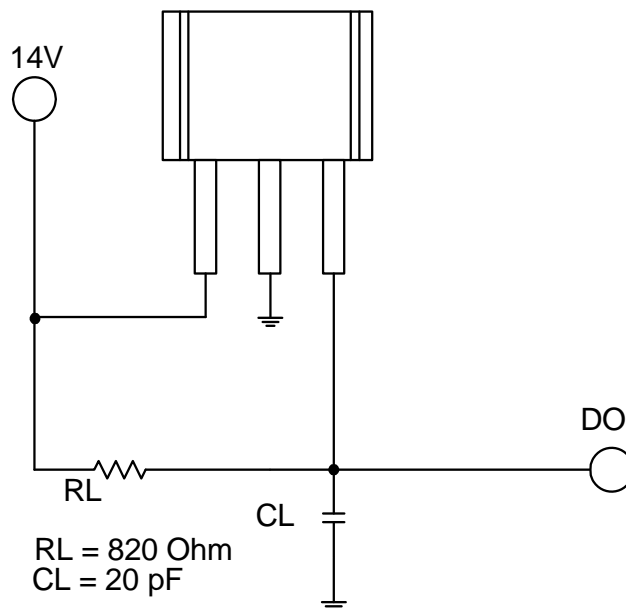
Test Circuit

Test Circuit

Magnetic Characteristics ($T_A = 25^\circ\text{C}$, Note 7)

(1mT = 10 Gauss)

A grade

Symbol	Parameter	Min	Typ.	Max	Unit
Bops(south pole to brand side)	Operation Point	-	-	100	Gauss
Brps(south pole to brand side)	Release Point	10	-	-	Gauss
$B_{hy}(B_{opx} - B_{rpx})$	Hysteresis	-	80	-	Gauss

B grade (for SIP-3L only)

Symbol	Parameter	Min	Typ.	Max	Unit
Bops(south pole to brand side)	Operation Point	-	-	130	Gauss
Brps(south pole to brand side)	Release Point	10	-	-	Gauss
$B_{hy}(B_{opx} - B_{rpx})$	Hysteresis	-	80	-	Gauss

Notes: 7. Magnetic characteristics are for design information, which will vary with supply voltage, operating temperature and after soldering.

Application Information

Operating principle:

ATS137 is a three-pin Hall Effect switch IC which can turn magnetic flux variety to digital output signal. In other words, it is an interface from magnetic system to an electrical one by Hall effect. The illustrations are shown in Fig.1.

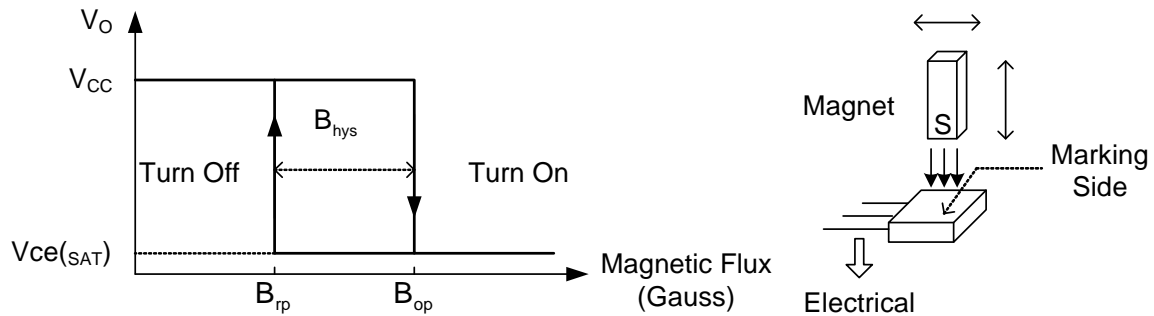

Fig.1 Hall-Effect Switch

Output driver is open-collector topology and maximum sink current (I_{sink}) is 25mA. The illustrated circuit is shown as Fig. 2.

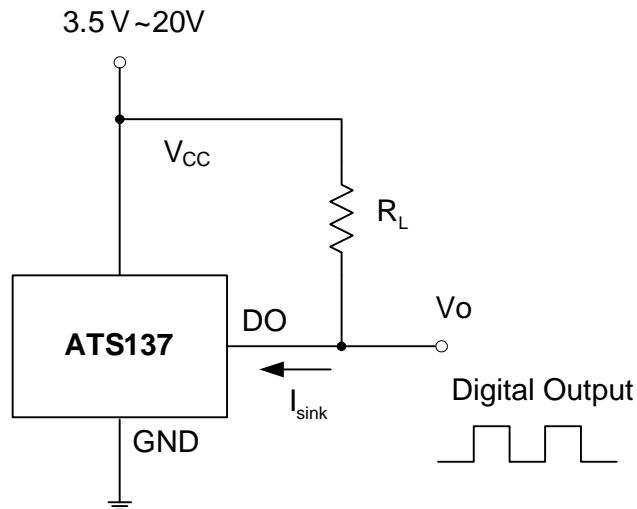

Fig.2 Application Circuit

Application Information (Continued)

V_o will turn on (low) if the S magnetic flux larger than the operation point (B_{op}), and turns off whenever the magnetic flux is removed and lower than the release point (B_{rp}). The related waveforms are shown in Fig.3.

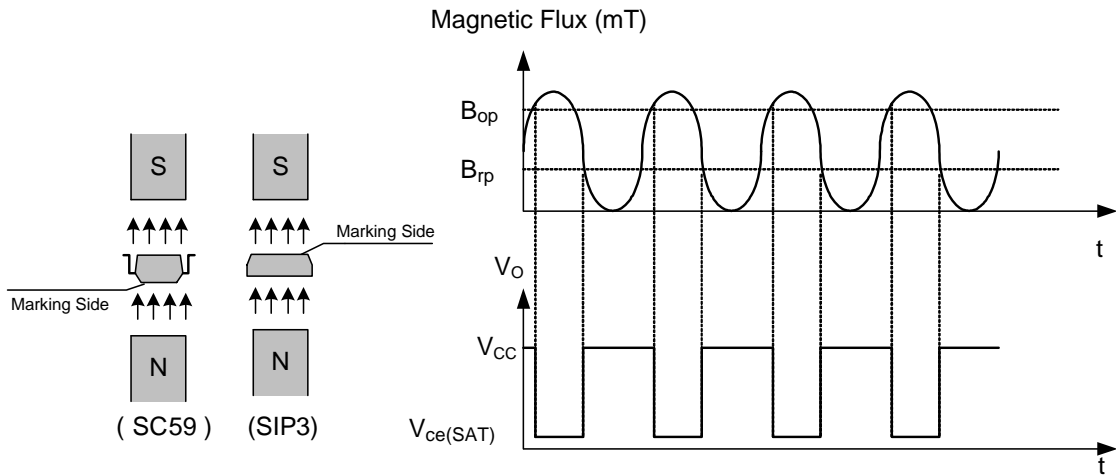

Fig.3 V_o and Magnetic Flux Variety

The major applications are for contactless switching and shown as follows:

- VCD/DVD loader, CD/DVD ROM: Detect if the tray is opened or closed.
- Cover detector (open/close): Cellular phone cover detector, refrigerator door detector, microwave oven door sensor, etc.
- Home safety: instead of reed relay to detect the situation of door/window.
- Due to contactless and without mechanical contact point, its reliability and life cycle are much longer than reed relay. In addition, its switching speed is much faster than mechanical devices.

Performance Characteristics

(1) SIP-3L

T_A (°C)	25	50	60	70	80	85	90	95	100
P _D (mW)	550	440	396	352	308	286	264	242	220
T_A (°C)	105	110	115	120	125	130	135	140	150
P _D (mW)	198	176	154	132	110	88	66	44	0

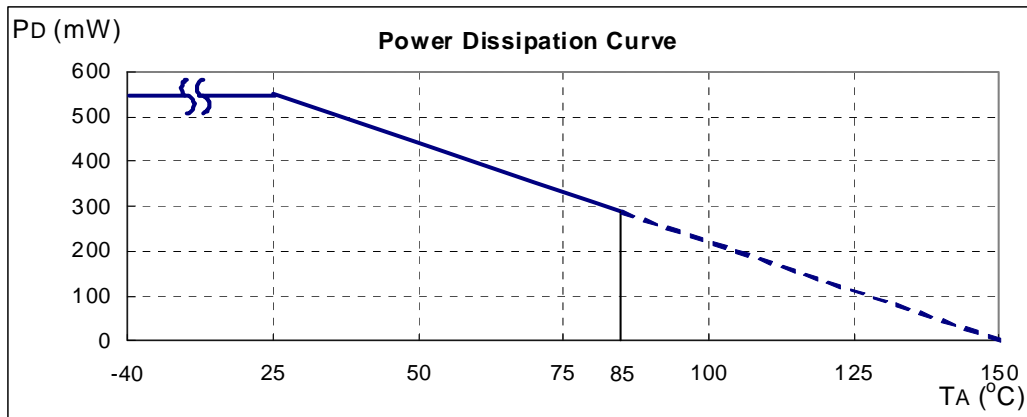

(2) SC59-3L (commonly known as SOT23 in Asia)

T_A (°C)	25	50	60	70	80	85	90	100	110	120	125	130	140	150
P _D (mW)	230	184	166	147	129	120	110	92	74	55	46	37	18	0

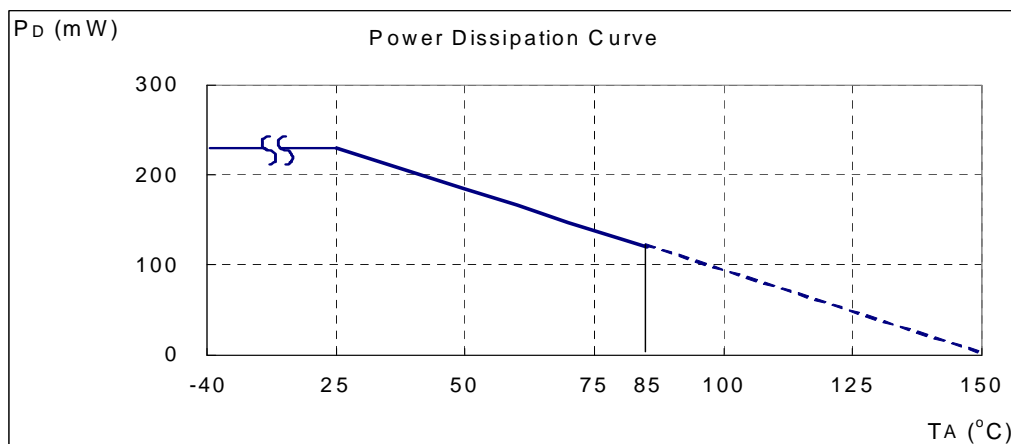

Marking Information

(1) SIP-3L

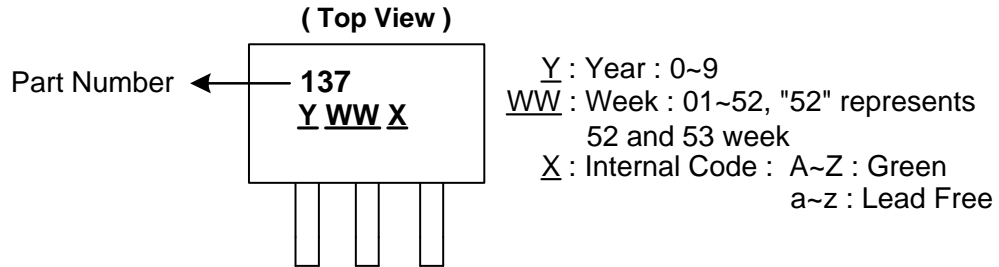

(2) SC59-3L (Commonly known as SOT23 in Asia)

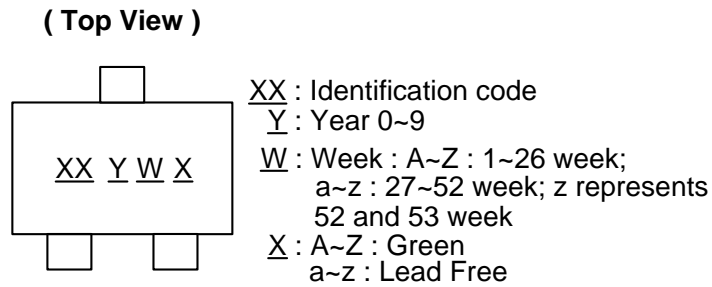

Part Number	Package	Identification Code
ATS137	SC59-3L	JA

Package Information (All Dimensions in mm)

(1) Package Type: SIP-3L for Bulk pack

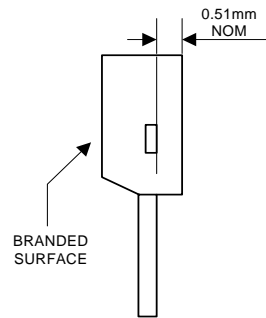

Active Area Depth

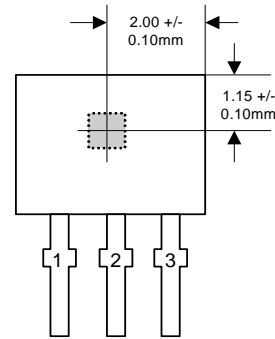

Sensor Location

Package Dimension

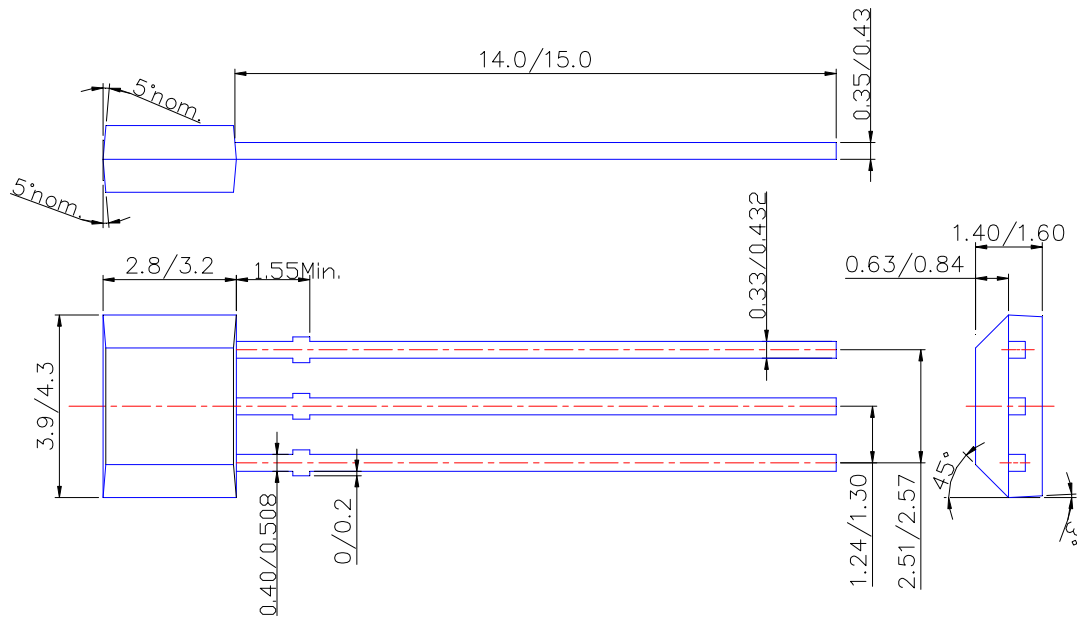

IMPORTANT NOTICE

DIODES INCORPORATED MAKES NO WARRANTY OF ANY KIND, EXPRESS OR IMPLIED, WITH REGARDS TO THIS DOCUMENT, INCLUDING, BUT NOT LIMITED TO, THE IMPLIED WARRANTIES OF MERCHANTABILITY AND FITNESS FOR A PARTICULAR PURPOSE (AND THEIR EQUIVALENTS UNDER THE LAWS OF ANY JURISDICTION).

Diodes Incorporated and its subsidiaries reserve the right to make modifications, enhancements, improvements, corrections or other changes without further notice to this document and any product described herein. Diodes Incorporated does not assume any liability arising out of the application or use of this document or any product described herein; neither does Diodes Incorporated convey any license under its patent or trademark rights, nor the rights of others. Any Customer or user of this document or products described herein in such applications shall assume all risks of such use and will agree to hold Diodes Incorporated and all the companies whose products are represented on Diodes Incorporated website, harmless against all damages.

Diodes Incorporated does not warrant or accept any liability whatsoever in respect of any products purchased through unauthorized sales channel.

Should Customers purchase or use Diodes Incorporated products for any unintended or unauthorized application, Customers shall indemnify and hold Diodes Incorporated and its representatives harmless against all claims, damages, expenses, and attorney fees arising out of, directly or indirectly, any claim of personal injury or death associated with such unintended or unauthorized application.

Products described herein may be covered by one or more United States, international or foreign patents pending. Product names and markings noted herein may also be covered by one or more United States, international or foreign trademarks.

LIFE SUPPORT

Diodes Incorporated products are specifically not authorized for use as critical components in life support devices or systems without the express written approval of the Chief Executive Officer of Diodes Incorporated. As used herein:

A. Life support devices or systems are devices or systems which:

1. are intended to implant into the body, or
2. support or sustain life and whose failure to perform when properly used in accordance with instructions for use provided in the labeling can be reasonably expected to result in significant injury to the user.

B. A critical component is any component in a life support device or system whose failure to perform can be reasonably expected to cause the failure of the life support device or to affect its safety or effectiveness.

Customers represent that they have all necessary expertise in the safety and regulatory ramifications of their life support devices or systems, and acknowledge and agree that they are solely responsible for all legal, regulatory and safety-related requirements concerning their products and any use of Diodes Incorporated products in such safety-critical, life support devices or systems, notwithstanding any devices- or systems-related information or support that may be provided by Diodes Incorporated. Further, Customers must fully indemnify Diodes Incorporated and its representatives against any damages arising out of the use of Diodes Incorporated products in such safety-critical, life support devices or systems.

Copyright © 2010, Diodes Incorporated

www.diodes.com

Mouser Electronics

Authorized Distributor

Click to View Pricing, Inventory, Delivery & Lifecycle Information:

Diodes Incorporated:

[ATS137-PL-B-A](#) [ATS137-PL-B-B](#) [ATS137-WG-7-A](#) [ATS137-PG-A-A](#) [ATS137-PG-A-B](#) [ATS137-PG-B-A](#) [ATS137-PG-B-B](#) [ATS137-WL-7-A](#) [ATS137-PL-A-B](#) [ATS137-PL-A-A](#)