

A

B

C

D

A

B

C

D

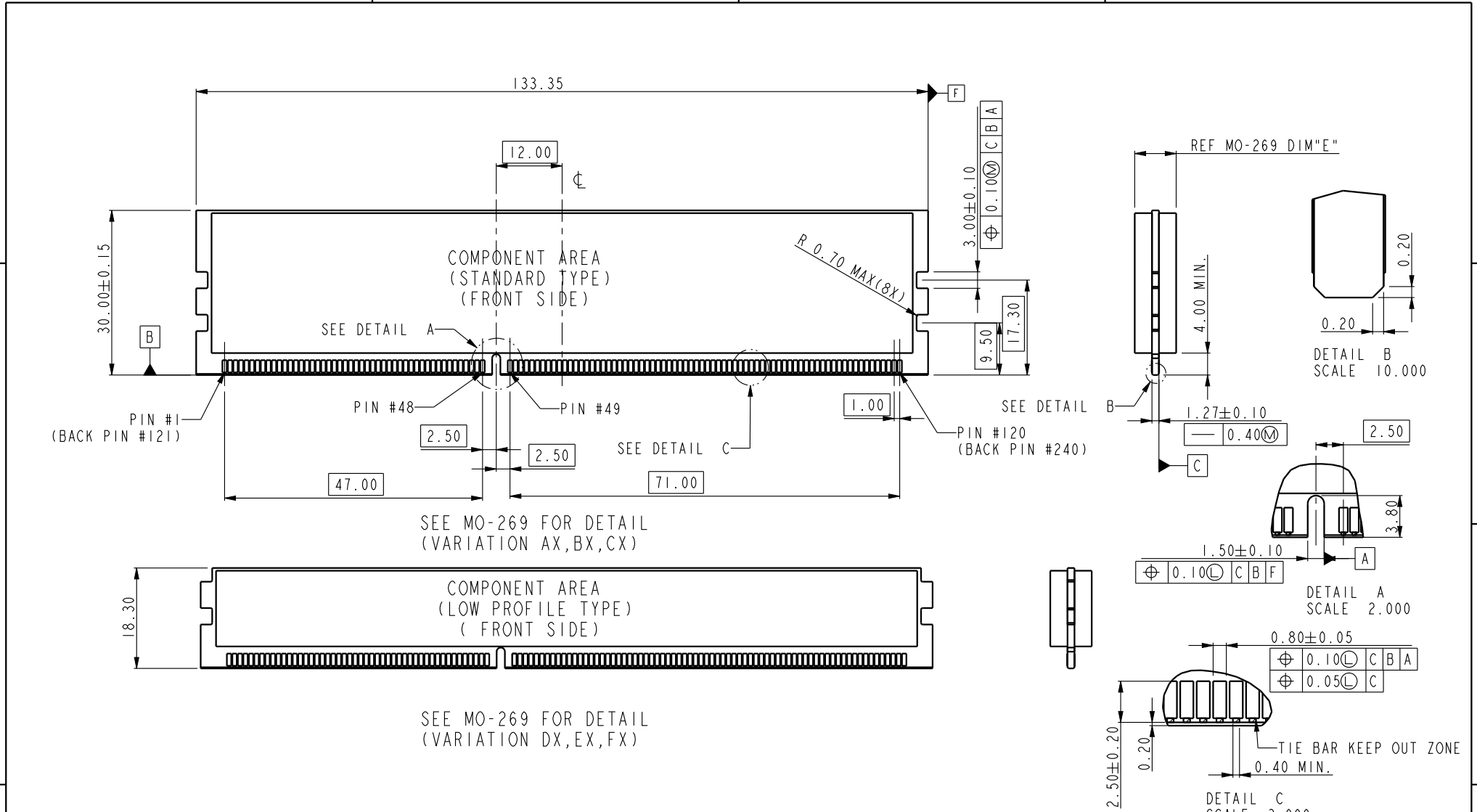

spec ref *		dr Rick Bian		2010/07/04		projection		size		scale	
tolerance std		eng Jeny Ren		2018/02/08		mm		A4		0.500	
ASME Y14.5		chr -		-		←→		ecn no		ELX-DG-28885-1	
ASME Y14.5		appr Nickor Zuo		2018/02/09		product family		rel level		Released	
surface	linear	0.X	±0.30	Amphenol FCI	title				dwg no	10079248	rev
		0.XX	±0.15		SMT DDRIII SOCKET ASS'Y						
		0.XXX	±0.05		DDRIII, 240P SOCKET (FOR RDIMM MODULE)						
ASME Y14.5	angular	0°	±2°	www.fci.com	cat. no.	*	Product - Customer Drw	sheet 2 of 5			

A

B

C

D

A

B

C

D

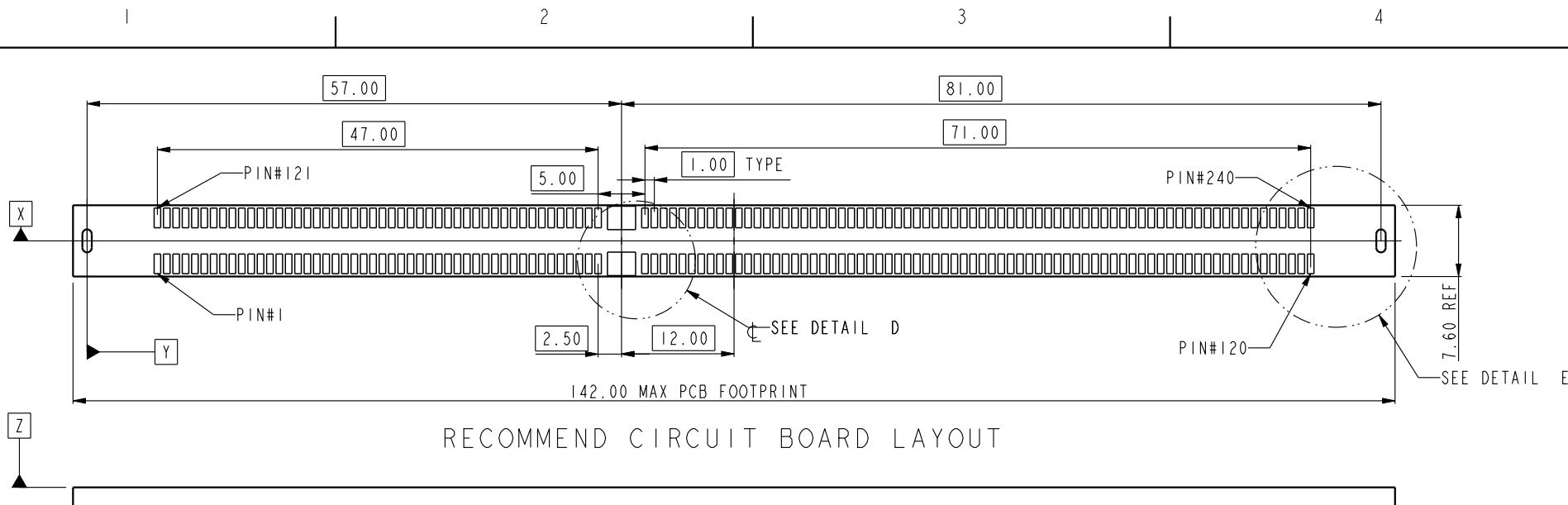

RECOMMEND CIRCUIT BOARD LAYOUT

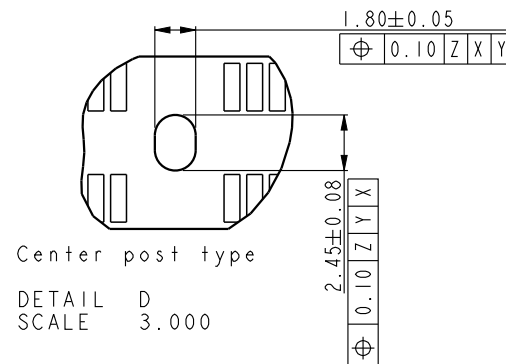
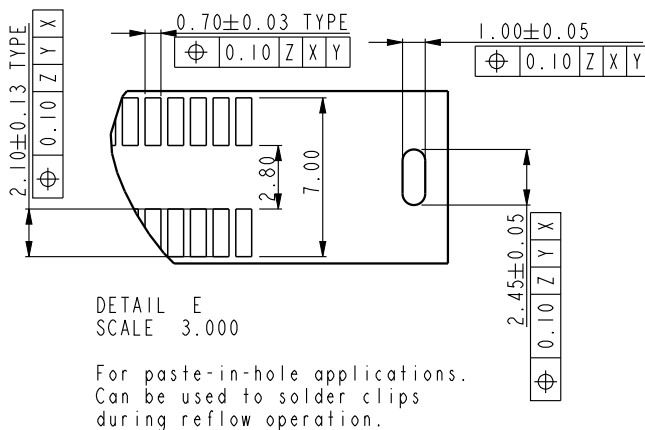
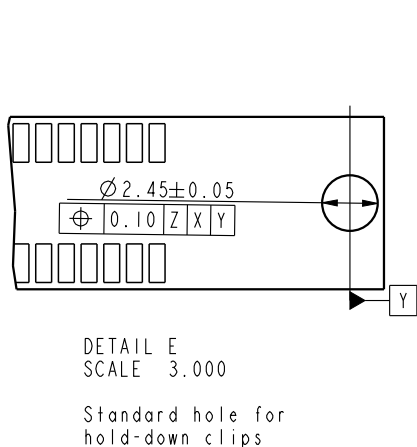

spec ref *		dr Rick Bian		2010/07/04		projection		size A4		scale 0.500	
tolerance std		eng Jeny Ren		2018/02/08		 mm		ecn no ELX-DG-28885-1			
ASME Y14.5		chr -		-				rel level Released			
surface		appr Nickor Zuo		2018/02/09		product family		rev			
 ASME Y14.5		linear		0.X		±0.30		Amphenol FCI title SMT DDRIII SOCKET ASS'Y DDRIII, 240P SOCKET (FOR RDIMM MODULE)		www.fci.com cat. no. * Product - Customer Drw	
				0.XX		±0.15					
				0.XXX		±0.05		dwg no 10079248		sheet 3 of 5	
		angular		0°		±2°		rev Y			

A

B

C

D



SCALE 0.500

10079248-10***
CENTER SMT HOLDOWN TYPE



SCALE 0.500

10079248-11***
3 FORK LOCK TYPE



SCALE 0.500

10079248-12***
3 SMT HOLDOWN TYPE

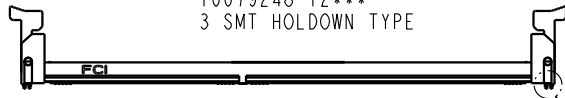

SCALE 0.500

10079248-13***
3 SMT HOLDOWN AND 2 PLASTIC POST TYPE



SCALE 0.500

10079248-15***
3 PLASTIC POST TYPE

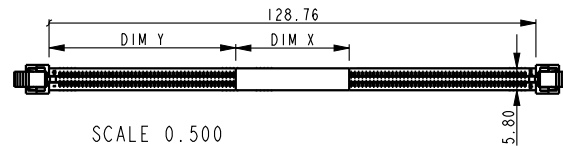

SCALE 0.500
WITH MYLAR TAPE (OPTIONAL)

10079248 - □ □ □ □ □

STYLE : MECHANICAL KEYING

1 : 1.5 VOLT. W/ CENTER KEY

HOLD DOWN TYPE

- 0 : CENTER HOLD DOWN, FORKLOCK AT BOTH END
- 1 : 3 FORKLOCK TYPE
- 2 : 3 SMT HOLDOWN TYPE
- 3 : 3 SMT HOLDOWN AND 2 PLASTIC POST
- 5 : 3 PLASTIC POST TYPE

PACKAGE AND MYLAR OPTION

- ~~0 : SOFT TRAY WITHOUT MYLAR (OBSOLETE)~~
- 1 : HARD TRAY WITH MYLAR 1
- 2 : HARD TRAY WITHOUT MYLAR
- ~~3 : SOFT TRAY WITH MYLAR 1 (OBSOLETE)~~
- 4 : SPECIAL HARD TRAY WITH MYLAR 1
- 5 : SPECIAL HARD TRAY WITHOUT MYLAR
- 6 : HARD TRAY WITH MYLAR 2
- 7 : HARD TRAY WITH MYLAR 3
- 8 : HARD TRAY WITH MYLAR 4
- 9 : SMALLER HARD TRAY WITHOUT MYLAR

PLATING

CODE	CONTACT	SOLDERTAIL	UNDERPLATE	NOTE
1	10u" (0.25um) MIN. GOLD	100u" (2.54um) MIN. TIN-LEAD	50u" (1.27um) MIN. NICKEL OVERALL	CONTACT NON-LUBRICANT
2	15u" (0.38um) MIN. GOLD			
3	30u" (0.76um) MIN. GOLD			
4	GOLD FLASH			
5	10u" (0.25um) MIN. GOLD			CONTACT LUBRICATED
6	15u" (0.38um) MIN. GOLD			
7	30u" (0.76um) MIN. GOLD			
8	GOLD FLASH			
3S	5u" (0.125um) MIN. GOLD			CONTACT LUBRICATED WITH HIGH PERFORMANCE POLY A-OLEFIN LUBRICANT
1LF	10u" (0.25um) MIN. GOLD	100u" (2.54um) MIN. 100% MATT TIN	50u" (1.27um) MIN. NICKEL OVERALL	CONTACT NON-LUBRICANT
2LF	15u" (0.38um) MIN. GOLD			
3LF	30u" (0.76um) MIN. GOLD			
4LF	GOLD FLASH			
5LF	10u" (0.25um) MIN. GOLD			CONTACT LUBRICATED
6LF	15u" (0.38um) MIN. GOLD			
7LF	30u" (0.76um) MIN. GOLD			
8LF	GOLD FLASH			
3SLF	5u" (0.125um) MIN. GOLD			CONTACT LUBRICATED WITH HIGH PERFORMANCE POLY A-OLEFIN LUBRICANT
7SLF	30u" (0.76um) MIN. GOLD			

COLOR OF HOUSING AND EJECTOR

- 0 : BLACK HOUSING + IVORY EJECTOR
- 1 : BLACK HOUSING + BLACK EJECTOR
- 2 : BLACK HOUSING + BLUE(661C) EJECTOR
- 3 : BLACK HOUSING + YELLOW(123C) EJECTOR

spec ref	*	dr	Rick Bian	2010/07/04	projection	mm	size	A4	scale	0.500
tolerance std	TOLERANCES UNLESS OTHERWISE SPECIFIED	eng	Jeny Ren	2018/02/08			ecn no	ELX-DG-28885-1	rel level	Released
ASME Y14.5		chr	-	-						
surface		linear	appr	Nickor Zuo			2018/02/09	product family		
ASME Y14.5	0.X	±0.30		title SMT DDRIII SOCKET ASS'Y DDRIII,240P SOCKET(FOR RDIMM MODULE)	dwg no 10079248	rev Y				
	0.XX	±0.15								
0.XXX	±0.05									
	angular	0°	±2°	www.fci.com	cat. no.	*	Product - Customer Drw	sheet 4 of 5		

A

B

C

D

A

B

C

D

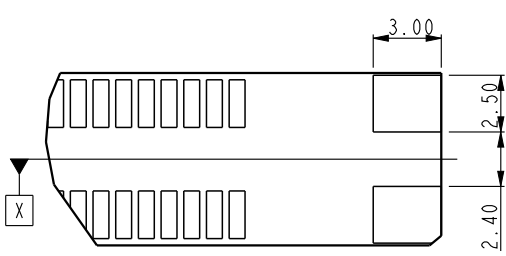

DETAIL E
SCALE 3.000

For smt holddown type

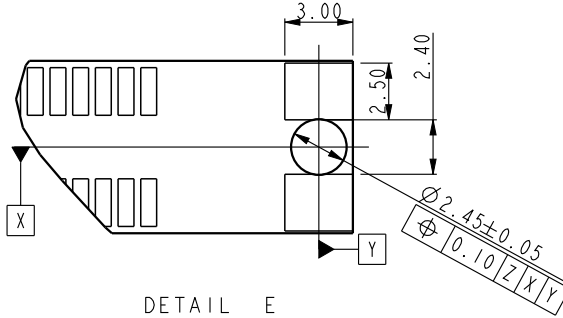

DETAIL E
SCALE 3.000

For 3smt holddown + 2plastic post type

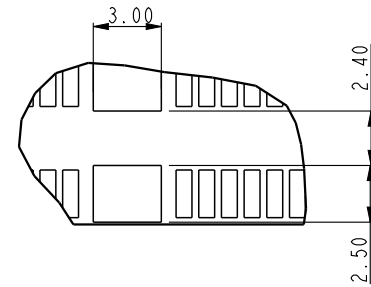

Center smt holddown type

DETAIL D
SCALE 3.000

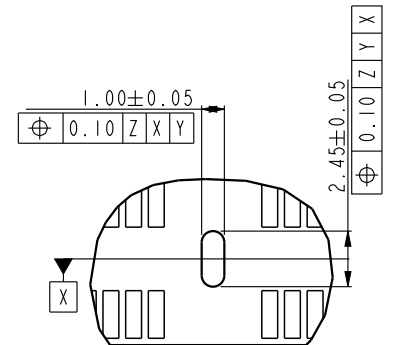

Center forklock type

DETAIL D
SCALE 3.000

NOTES:

- MATERIAL:
HOUSING: HIGH PERFORMANCE RESINS, GLASS FILLED UL94V-0 RATED.
EJECTOR: HIGH PERFORMANCE RESINS, GLASS FILLED UL94V-0 RATED.
TERMINAL: HIGH PERFORMANCE COPPER ALLOY
METAL CLIP: COPPER ALLOY.
- FCI LOGO TO BE APPROXIMATELY LOCATED AS SHOWN ON PRINT.
- PRODUCT SPECIFICATION: GS-12-486.
- PACKAGING SPECIFICATION: GS-14-899.
- RECOMMENDED STENCIL THICKNESS NO LESS THAN 0.15 mm.
- FOR OPTIMUM PERFORMANCE, THE TIE BAR IS TO BE ON AN INTERNAL LAYER SO THAT THE REMNANT CANNOT CAUSE CONTACT DAMAGE.
- THE DATE CODE IS SHOWN "MMDDYY*": "*" MEANS PRODUCTION LINE.
- THIS PRODUCT MEETS EUROPEAN UNION DIRECTIVES AND OTHER COUNTRY REGULATIONS AS DESCRIBED IN GS-22-008.
- THE HOUSING WILL WITH STAND EXPOSURE TO 260°C PEAK TEMPERATURE FOR 10 SECONDS IN AN IR REFLOW SOLDERING APPLICATION.
- PRODUCT APPLICATION SPEC GS-20-089.
- THE HOLDDOWN TYPES ARE OPTION FOR HOLDDOWN OR FORKLOCK.

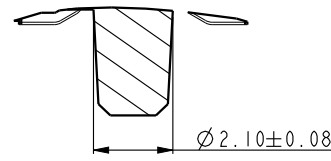

SECTION K-K
SCALE 5.000

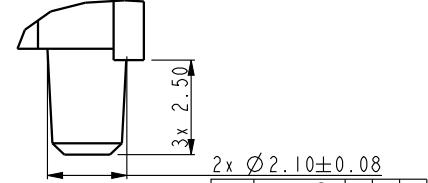

DETAIL M
SCALE 5.000

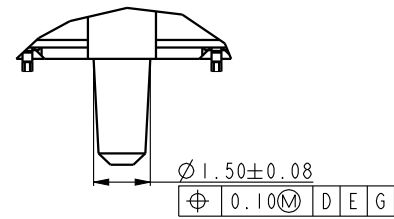

DETAIL J
SCALE 5.000

spec ref *		dr Rick Bian		2010/07/04		projection		size		scale							
tolerance std		eng Jeny Ren		2018/02/08				A4		0.500							
ASME Y14.5		chr -		-				ecn no		ELX-DG-28885-1							
TOLERANCES UNLESS OTHERWISE SPECIFIED		appr Nickor Zuo		2018/02/09		product family		rel level		Released							
surface				Amphenol FCI		title SMT DDRIII SOCKET ASS'Y DDRIII,240P SOCKET(FOR RDIMM MODULE)		dwg no 10079248		rev Y							
ASME Y14.5												linear		0.X		±0.30	
												angular		0°		±2°	
www.fci.com		cat. no.		*		Product - Customer Drw		sheet 5 of 5									

Mouser Electronics

Authorized Distributor

Click to View Pricing, Inventory, Delivery & Lifecycle Information:

FCI / Amphenol:

[10079248-11002LF](#) [10079248-11016LF](#) [10079248-12006LF](#) [10079248-12016LF](#) [10079248-13006LF](#) [10079248-13016LF](#) [10079248-10007LF](#) [10079248-15103LF](#) [10079248-10002LF](#) [10079248-10003LF](#) [10079248-10006LF](#) [10079248-10012LF](#) [10079248-11006LF](#) [10079248-11017LF](#) [10079248-12002LF](#) [10079248-12003LF](#) [10079248-13002LF](#) [10079248-15002LF](#) [10079248-12103LF](#) [10079248-11223LF](#) [10079248-10102LF](#) [10079248-10503LF](#) [10079248-15113LF](#) [10079248-10003](#) [10079248-10103LF](#) [10079248-11113LF](#) [10079248-11003LF](#) [10079248-15102LF](#) [10079248-11007LF](#) [10079248-15112LF](#) [10079248-11137LF](#) [10079248-15107LF](#) [10079248-11104LF](#) [10079248-13107LF](#) [10079248-11103LF](#) [10079248-11127LF](#) [10079248-15106LF](#) [10079248-15117LF](#) [10079248-10016LF](#) [10079248-11117LF](#) [10079248-10117LF](#) [10079248-11122LF](#) [10079248-11123LF](#) [10079248-11102LF](#) [10079248-11013LF](#) [10079248-10202LF](#) [10079248-10107LF](#) [10079248-13117LF](#) [10079248-11213LF](#) [10079248-10007](#) [10079248-13036LF](#) [10079248-11233LF](#) [10079248-11107LF](#) [10079248-12123LF](#) [10079248-10513LF](#) [10079248-11203LF](#) [10079248-11133LF](#) [10079248-11108LF](#) [10079248-15122LF](#) [10079248-15003LF](#) [10079248-11217LF](#) [10079248-15227LF](#) [10079248-11103SLF](#) [10079248-12107LF](#) [10079248-11226LF](#) [10079248-11216LF](#) [10079248-15217LF](#) [10079248-11227LF](#) [10079248-11222LF](#) [10079248-11202LF](#) [10079248-13203LF](#) [10079248-15103L](#) [10079248-15003L](#) [10079248-15222LF](#) [10079248-13303LF](#) [10079248-11117SLF](#) [10079248-11207LF](#) [10079248-10216LF](#) [10079248-13207LF](#) [10079248-13206LF](#) [10079248-10206LF](#) [10079248-12203LF](#) [10079248-12216LF](#) [10079248-12102LF](#) [10079248-11926LF](#) [10079248-11127SLF](#) [10079248-11107SLF](#) [10079248-15211LF](#) [10079248-11206LF](#) [10079248-13216LF](#) [10079248-10203](#) [10079248-13127LF](#) [10079248-12202LF](#) [10079248-15622LF](#) [10079248-15226LF](#) [10079248-15011LF](#) [10079248-13202LF](#) [10079248-10207](#) [10079248-15203LF](#) [10079248-15201LF](#)