

ABSOLUTE MAXIMUM RATINGS ($T_A = 25^\circ\text{C}$ unless otherwise noted) (Note 1)

PARAMETER	SYMBOL	LIMIT	UNIT
Input Supply Voltage	V_{IN}	-20~ +20	V
Enable Input Voltage	V_{CE}	-20~ +20	V
Power Dissipation (Note 2)	P_D	Internal limited	
Thermal Resistance	$R_{\theta JA}$	220	$^\circ\text{C/W}$
Operating Junction Temperature Range	T_J	-40 ~ +125	$^\circ\text{C}$
Storage Temperature Range	T_{STG}	-65 ~ +150	$^\circ\text{C}$
Lead Soldering Temperature (260 $^\circ\text{C}$)		5	S

RECOMMEND OPERATING RATING (Note 2)

PARAMETER	SYMBOL	LIMIT	UNIT
Input Supply Voltage	V_{IN}	+2.5 ~ +16	V
Enable Input Voltage	V_{CE}	0 ~ V_{IN}	V

ELECTRICAL SPECIFICATIONS

($V_{IN} = V_O + 1\text{V}$, $I_O = 100\mu\text{A}$, $C_{OUT} = 1\mu\text{F}$, $V_{ce} \geq 2\text{V}$, $T_A = 25^\circ\text{C}$ unless otherwise noted)

PARAMETER	CONDITIONS	MIN	TYP	MAX	UNIT	
Output Voltage	$V_{IN} = V_O + 1\text{V}$	-3	--	3	%	
	$-40^\circ\text{C} \leq T_J \leq +125^\circ\text{C}$	-4	--	4		
Output Voltage Temp. Coefficient	(Note 5)	--	50	200	ppm/ $^\circ\text{C}$	
Line Regulation	$V_O + 1\text{V} \leq V_{IN} \leq 16\text{V}$	--	0.008	0.3	%	
Load Regulation (Note 6)	$0.1\text{mA} \leq I_O \leq 80\text{mA}$	--	0.08	0.3	%	
Dropout Voltage (Note 7)	$I_O = 100\mu\text{A}$	--	50	--	mV	
	$I_O = 20\text{mA}$	--	230	300		
	$I_O = 50\text{mA}$	--	280	370		
	$I_O = 80\text{mA}$	--	320	420		
Quiescent Current	$V_{EN} \leq 0.4\text{V}$ (shutdown)	--	0.01	10	μA	
Ground Pin Current (Note 8)	$V_{EN} \geq 2\text{V}$ (active)	$I_O = 100\mu\text{A}$	--	80	--	μA
		$I_O = 20\text{mA}$	--	225	750	
		$I_O = 50\text{mA}$	--	850	--	
		$I_O = 80\text{mA}$	--	1800	3000	
Output Current Limit	$V_{OUT} = 0\text{V}$	--	250	500	mA	
Power Supply Rejection Ratio	At $f = 100\text{Hz}$, $I_O = 100\mu\text{A}$,	--	65	--	dB	
Thermal Regulation (Note 9)		--	0.05	--	%/W	

ELECTRICAL SPECIFICATIONS

($V_{IN} = V_O + 1V$, $I_O = 100\mu A$, $C_{OUT} = 1\mu F$, $V_{ce} \geq 2V$, $T_A = 25^\circ C$ unless otherwise noted)

Enable Function

PARAMETER	CONDITIONS	MIN	TYP	MAX	UNIT
Enable Input Logic-Low Voltage	Regulation shutdown	--	--	0.6	V
Enable Input Logic-High Voltage	Regulation enable	2.0	--	--	V
Enable Input Current	$V_{IL} \leq 0.6V$	--	0.01	1	μA
	$V_{IH} \geq 2.0V$	--	15	50	V

Note:

1. Exceeding the absolute maximum rating may damage the device.
2. The maximum allowable power dissipation at any T_A is $P_{D(MAX)} = [T_{J(MAX)} - T_a] + R_{\theta JA}$. Exceeding the maximum allowable power dissipation will result in excessive die temperature, and the regulator will go into thermal shutdown.
3. Devices are ESD sensitive. Handling precautions recommended.
4. The device is not guaranteed to function outside its operating rating.
5. Output voltage temperature coefficient is defined as the worst case voltage change divided by the total temperature range.
6. Regulation is measured at constant junction temperature using low duty cycle pulse testing. Parts are tested for load regulation in the load range from 1mA to 80mA. Changes in output voltage due to heating effects are covered by the thermal regulation specification.
7. Dropout voltage is defined as the input to output differential at which the output voltage drops 2% below its nominal value measured at 1V differential.
8. Ground pin current is the regulator quiescent current plus pass transistor base current. The total current drawn from the supply is the sum of the load current plus the ground pin current.
9. Thermal regulation is defined as the change in output voltage at a time "t" after a change in power dissipation is applied, excluding load or line regulation effects. Specifications are for a 80mA load pulse at $V_{IH} = 16V$ for $t = 10ms$.

ORDERING INFORMATION

OUTPUT VOLTAGE	PART NO.	PACKAGE	PACKING
3.3V	TS5213CX533 RFG	SOT-25	3,000pcs / 7" Reel
5V	TS5213CX550 RFG	SOT-25	3,000pcs / 7" Reel

Note:

1. Compliant to RoHS Directive 2011/65/EU and in accordance to WEEE 2002/96/EC.
2. Halogen-free according to IEC 61249-2-21 definition.

BLOCK DIAGRAMS

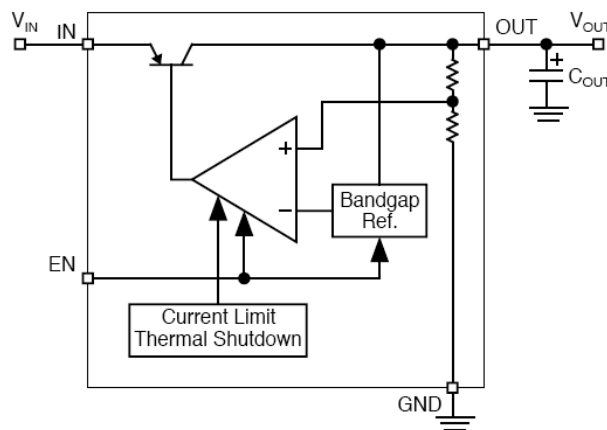

APPLICATION INFORMATION

Enable Input

TS5213 series feature an active-high (>2V) enable (EN) input that allows ON/OFF control of the regulator. Current drain reduces to “zero” when the device is shutdown, with only micro-amperes of leakage current. The EN is compatible with CMOS logic interfacing. EN may be directly tied to V_{IH} and pulled up to the maximum supply voltage.

Input Capacitor Requirement

An input capacitor of 0.17 μ F or greater is recommended when the device is more than 10” away from the bulk AC supply capacitance or when the supply is a battery.

Output Capacitor Requirement

The TS5213 series requires an output capacitor to maintain stability and improve transient response is necessary. The TS5213 is ultra-stable, requiring only 0.47 μ F of output capacitance for stability. It is stable with all type of capacitors, including the tiny, low-ESR ceramic chip capacitors. The output capacitor value may be increased without limit.

No Load Stability

The TS5213 series will remain stable and in regulation with no load, unlike many other voltage regulators. This is especially important in CMOS RAM keep alive applications.

APPLICATION INFORMATION (CONTINUE)

Thermal Characteristics

TS5213 series is designed to provide 80mA of continuous current in a very small package. Maximum power dissipation can be calculated based on the output current and the voltage drop across the part. To determine the maximum power dissipation of the package, use the junction-ambient thermal resistance of the device and the following basic equation:

$$P_{D(MAX)} = [T_{J(MAX)} - T_A] / \Theta_{JA}$$

$T_{J(MAX)}$ is the maximum junction temperature of the die(125°C), and T_a is the ambient operating temperature. Θ_{JA} is layout dependent, the actual power dissipation of the regulator circuit can be determined using the equation:

$$P_D = (V_{IN} - V_{OUT}) * I_{OUT} + V_{IN} * I_{GND}$$

Substituting $P_{D(MAX)}$ for P_D and solving for the operating conditions that are critical to the application will give the maximum operating conditions for the regulator circuit. For example, when operating the TS5213CX550 at room temperature with a minimum footprint layout, the maximum input voltage for a set output current can be determined as follows:

$$P_{D(MAX)} = (125^{\circ}\text{C} - 25^{\circ}\text{C}) / 220^{\circ}\text{C/W}$$

$$P_{D(MAX)} = 455\text{mW}$$

The junction to ambient thermal resistance for the minimum footprint is 220°C/W, the maximum power dissipation must not be exceeded for proper operation. Using the output voltage of 5.0V and an output current of 80mA, the maximum input voltage can be determined. Form the electrical characteristics table, the maximum ground current for 80mA output current is 1mA.

$$445\text{mW} = (V_{IN} - 5.0\text{V}) * 80\text{mA} + V_{IN} * 1.8\text{mA}$$

$$445\text{mW} = V_{IN} * 80\text{mA} - 5.0 * 80\text{mA} + V_{IN} * 1.8\text{mA}$$

$$445\text{mW} = V_{IN} * 80\text{mA} - 400\text{mW} + V_{IN} * 1.8\text{mA}$$

$$845\text{mW} = V_{IN} * 81.8\text{mA}$$

$$V_{IN} (\text{max}) = 10.33\text{V}$$

Therefore, a 5.0V application at 80mA of output current can accept a maximum input voltage of 10.33V in a SOT-25 package.

CHARACTERISTICS CURVES

($T_C = 25^\circ\text{C}$ unless otherwise noted)

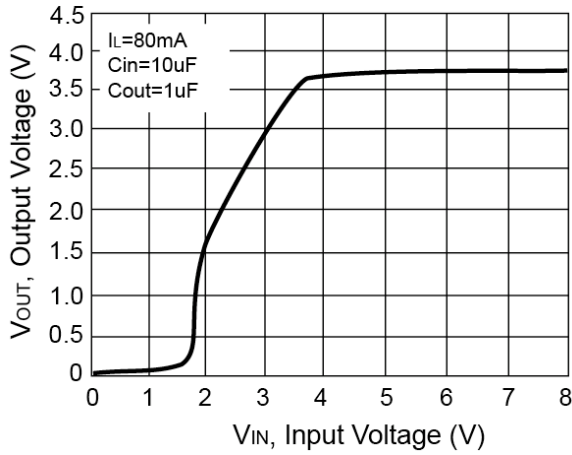

Figure 1. Output Voltage vs. Input Voltage

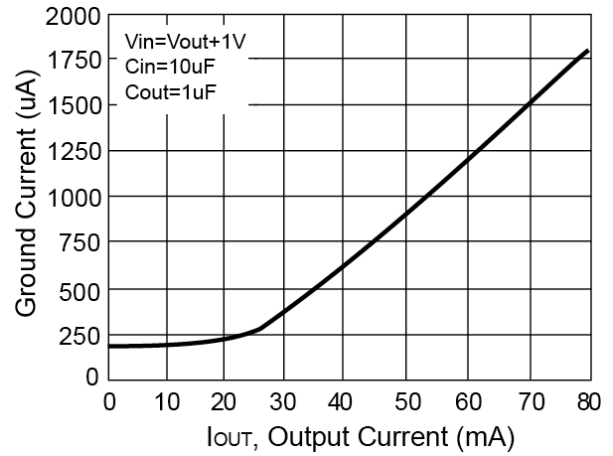

Figure 2. Ground Current vs. Output Current

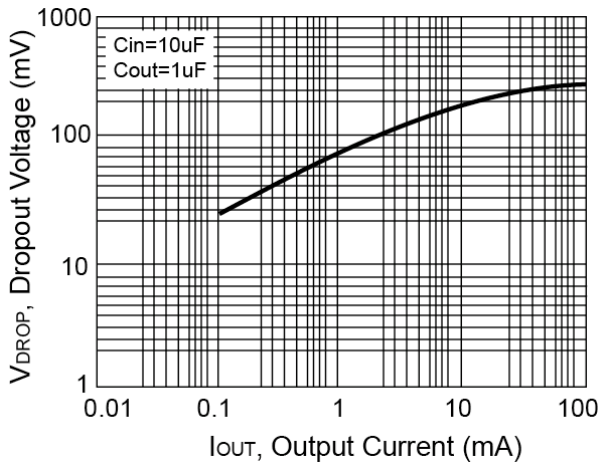

Figure 3. Dropout Voltage vs. Output Current

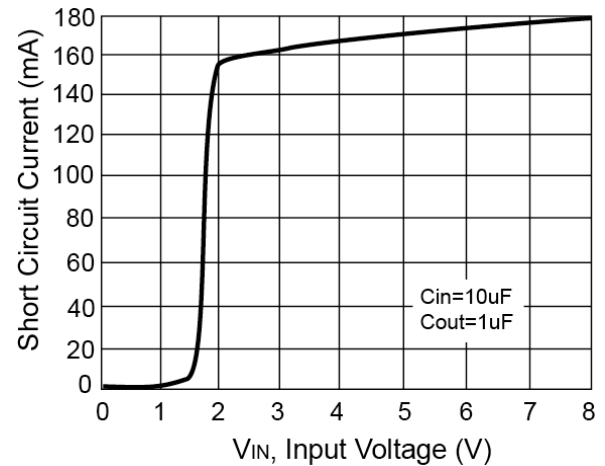

Figure 4. Short Circuit Current vs. Input Voltage

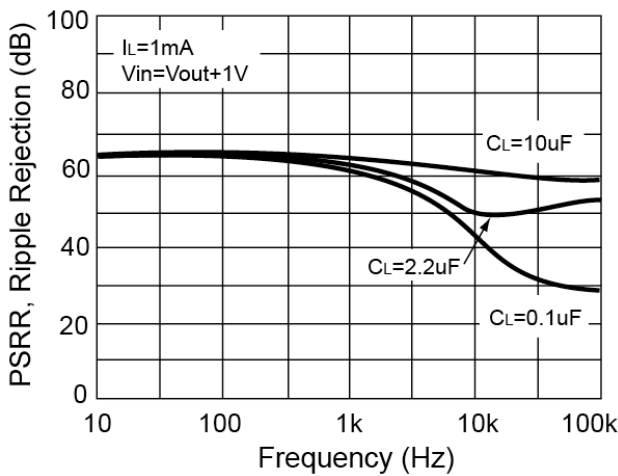

Figure 5. Ripple Rejection vs. Frequency

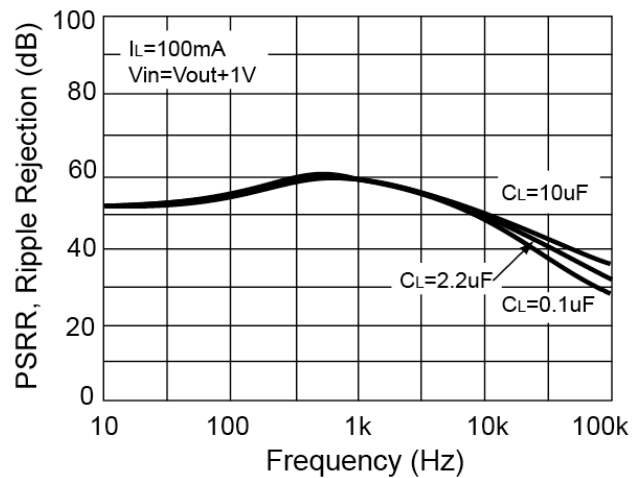
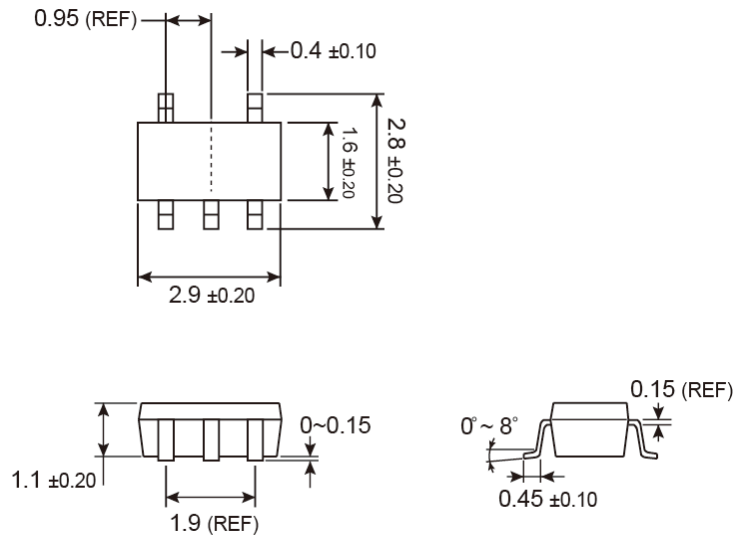

Figure 6. Ripple Rejection vs. Frequency

PACKAGE OUTLINE DIMENSIONS (Unit: Millimeters)

SOT-25



SUGGESTED PAD LAYOUT (Unit: Millimeters)

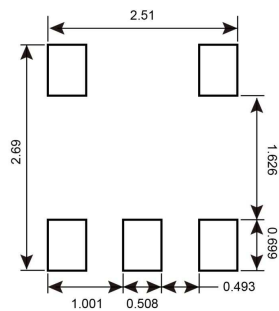

MARKING DIAGRAM

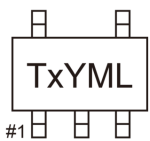

- T** = Device Code
- X** = Voltage Code (**5** = 5.0V, **S** = 3.3V)
- Y** = Year Code
- M** = Month Code for Halogen Free Product
 - O** =Jan **P** =Feb **Q** =Mar **R** =Apr
 - S** =May **T** =Jun **U** =Jul **V** =Aug
 - W** =Sep **X** =Oct **Y** =Nov **Z** =Dec
- L** = Lot Code (1~9, A~Z)

Notice

Specifications of the products displayed herein are subject to change without notice. TSC or anyone on its behalf, assumes no responsibility or liability for any errors or inaccuracies.

Information contained herein is intended to provide a product description only. No license, express or implied, to any intellectual property rights is granted by this document. Except as provided in TSC's terms and conditions of sale for such products, TSC assumes no liability whatsoever, and disclaims any express or implied warranty, relating to sale and/or use of TSC products including liability or warranties relating to fitness for a particular purpose, merchantability, or infringement of any patent, copyright, or other intellectual property right.

The products shown herein are not designed for use in medical, life-saving, or life-sustaining applications. Customers using or selling these products for use in such applications do so at their own risk and agree to fully indemnify TSC for any damages resulting from such improper use or sale.

Mouser Electronics

Authorized Distributor

Click to View Pricing, Inventory, Delivery & Lifecycle Information:

[Taiwan Semiconductor:](#)

[TS5213CX533](#) [TS5213CX550](#) [TS5213CX550 RFG](#) [TS5213CX533 RFG](#)