

Electrical Characteristics(Ta = 25°C)

| Part Number | Marking Code | Zener Voltage | | | Operating resistance | | Rising operating Resistance | | Reverse current | |
|---------------|--------------|--------------------|-------|---------------------|----------------------|---------------------|-----------------------------|---------------------|-----------------|--------------------|
| | | V _Z (V) | | | ZZT(Ohm) | | ZZK(Ohm) | | IR(μA) | |
| | | Min | Max | I _Z (mA) | Max | I _Z (mA) | Max | I _Z (mA) | Max | V _R (V) |
| CZRF52C2-HF | Z0 | 1.90 | 2.10 | 5 | 100 | 5 | 600 | 1 | 100 | 1 |
| CZRF52C2V2-HF | Z1 | 2.09 | 2.31 | 5 | 100 | 5 | 600 | 1 | 100 | 1 |
| CZRF52C2V4-HF | Z2 | 2.28 | 2.52 | 5 | 85 | 5 | 600 | 1 | 100 | 1 |
| CZRF52C2V7-HF | Z3 | 2.57 | 2.84 | 5 | 83 | 5 | 500 | 1 | 75 | 1 |
| CZRF52C3-HF | Z4 | 2.85 | 3.15 | 5 | 95 | 5 | 500 | 1 | 50 | 1 |
| CZRF52C3V3-HF | Z5 | 3.14 | 3.47 | 5 | 95 | 5 | 500 | 1 | 25 | 1 |
| CZRF52C3V6-HF | Z6 | 3.42 | 3.78 | 5 | 95 | 5 | 500 | 1 | 15 | 1 |
| CZRF52C3V9-HF | Z7 | 3.71 | 4.10 | 5 | 95 | 5 | 500 | 1 | 10 | 1 |
| CZRF52C4V3-HF | Z8 | 4.09 | 4.52 | 5 | 95 | 5 | 500 | 1 | 5 | 1 |
| CZRF52C4V7-HF | Z9 | 4.47 | 4.94 | 5 | 78 | 5 | 500 | 1 | 5 | 2 |
| CZRF52C5V1-HF | ZA | 4.85 | 5.36 | 5 | 60 | 5 | 480 | 1 | 0.1 | 0.8 |
| CZRF52C5V6-HF | ZB | 5.32 | 5.88 | 5 | 40 | 5 | 400 | 1 | 0.1 | 1 |
| CZRF52C6V2-HF | ZC | 5.89 | 6.51 | 5 | 10 | 5 | 200 | 1 | 0.1 | 2 |
| CZRF52C6V8-HF | ZE | 6.46 | 7.14 | 5 | 8 | 5 | 150 | 1 | 0.1 | 3 |
| CZRF52C7V5-HF | ZF | 7.13 | 7.88 | 5 | 7 | 5 | 50 | 1 | 0.1 | 5 |
| CZRF52C8V2-HF | ZG | 7.79 | 8.61 | 5 | 7 | 5 | 50 | 1 | 0.1 | 6 |
| CZRF52C9V1-HF | ZH | 8.65 | 9.56 | 5 | 10 | 5 | 50 | 1 | 0.1 | 7 |
| CZRF52C10-HF | ZJ | 9.50 | 10.50 | 5 | 15 | 5 | 70 | 1 | 0.1 | 7.5 |
| CZRF52C11-HF | ZK | 10.45 | 11.55 | 5 | 20 | 5 | 70 | 1 | 0.1 | 8.5 |
| CZRF52C12-HF | ZM | 11.40 | 12.60 | 5 | 20 | 5 | 90 | 1 | 0.1 | 9 |
| CZRF52C13-HF | ZN | 12.35 | 13.65 | 5 | 25 | 5 | 110 | 1 | 0.1 | 10 |
| CZRF52C15-HF | ZP | 14.25 | 15.75 | 5 | 30 | 5 | 110 | 1 | 0.1 | 11 |
| CZRF52C16-HF | ZQ | 15.20 | 16.80 | 5 | 40 | 5 | 170 | 1 | 0.1 | 12 |
| CZRF52C18-HF | ZR | 17.10 | 18.90 | 5 | 50 | 5 | 170 | 1 | 0.1 | 14 |
| CZRF52C20-HF | ZS | 19.00 | 21.00 | 5 | 50 | 5 | 220 | 1 | 0.1 | 15 |
| CZRF52C22-HF | ZT | 20.90 | 23.10 | 5 | 55 | 5 | 220 | 1 | 0.1 | 17 |
| CZRF52C24-HF | ZU | 22.80 | 25.20 | 5 | 80 | 5 | 220 | 1 | 0.1 | 18 |
| CZRF52C27-HF | ZV | 25.65 | 28.35 | 5 | 80 | 5 | 250 | 1 | 0.1 | 20 |
| CZRF52C30-HF | ZW | 28.50 | 31.50 | 5 | 80 | 5 | 250 | 1 | 0.1 | 23 |
| CZRF52C33-HF | ZX | 31.35 | 34.65 | 5 | 80 | 5 | 250 | 1 | 0.1 | 25 |
| CZRF52C36-HF | ZY | 34.20 | 37.80 | 5 | 90 | 5 | 250 | 1 | 0.1 | 27 |
| CZRF52C39-HF | ZZ | 37.05 | 40.95 | 5 | 90 | 5 | 300 | 1 | 0.1 | 29 |

Company reserves the right to improve product design , functions and reliability without notice.

REV:B

RATING AND CHARACTERISTIC CURVES (CZRF52C2-HF Thru. CZRF52C39-HF)

Fig.1 TEMPERATURE COEFFICIENTS

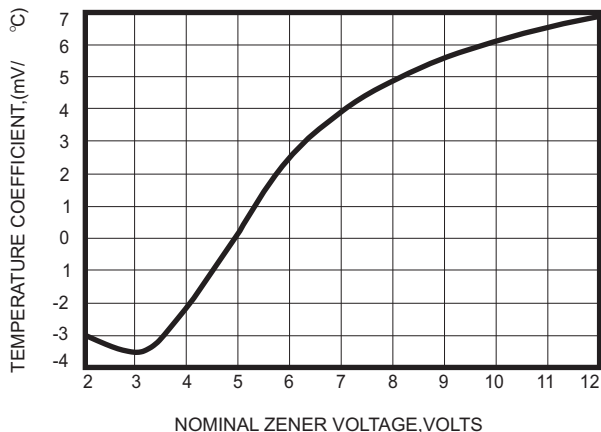

Fig.2 TEMPERATURE COEFFICIENTS

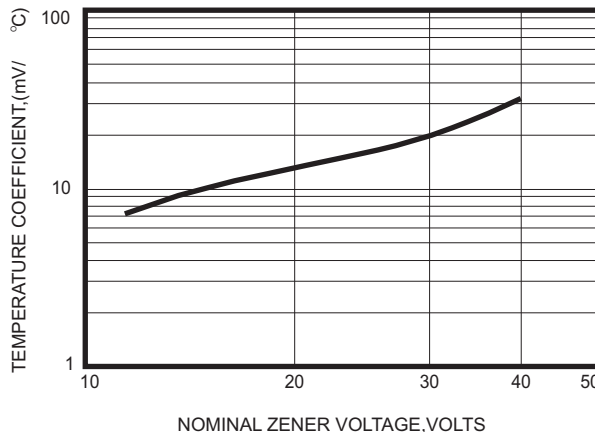

Fig.3 EFFECT OF ZENER VOLTAGE ON ZENER IMPEDANCE

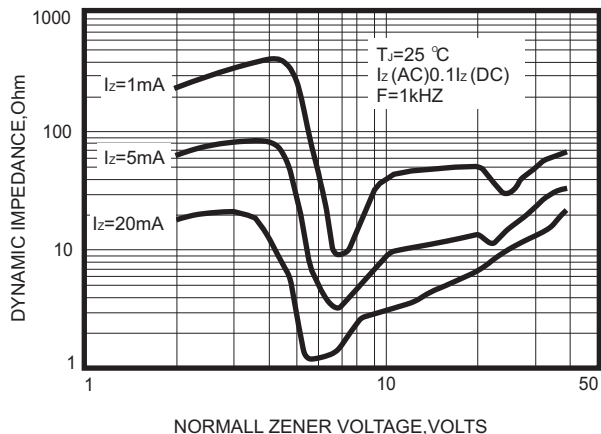

Fig.4 TYPICAL FORWARD VOLTAGE

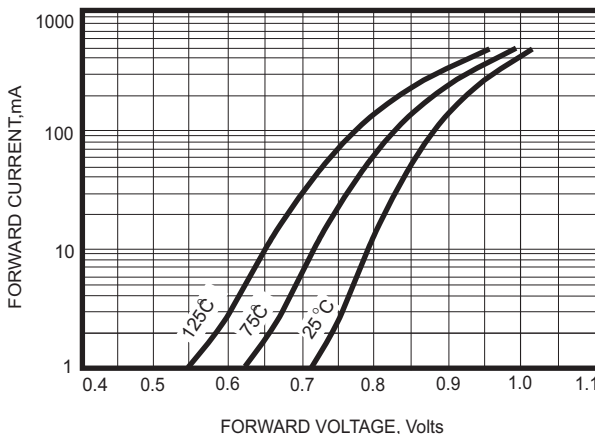

Fig.5 TYPICAL LEAKAGE CURRENT

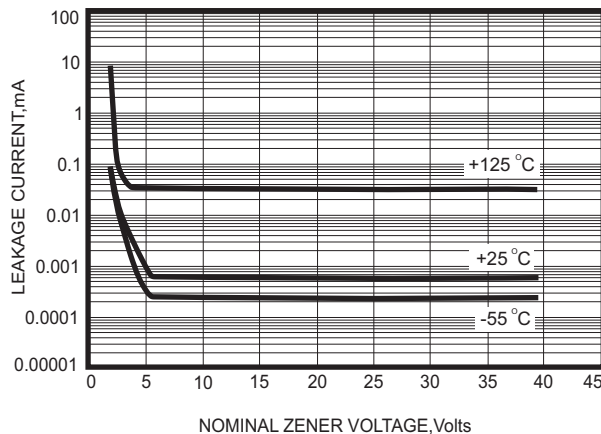
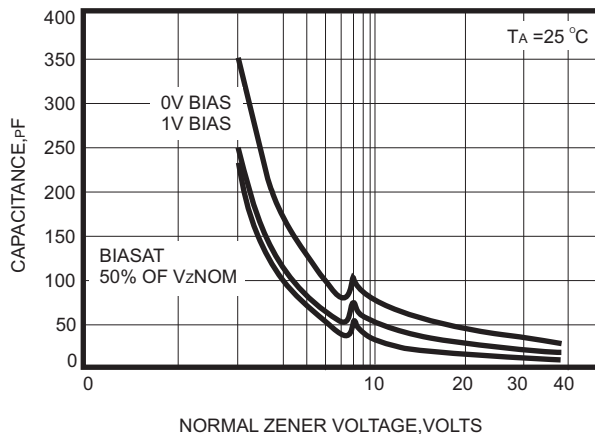

Fig.6 TYPICAL CAPACITANCE



Company reserves the right to improve product design, functions and reliability without notice.

REV:B

RATING AND CHARACTERISTIC CURVES (CZRF52C2-HF Thru. CZRF52C39-HF)

Fig.7 ZENER VOLTAGE VERSUS ZENER CURRENT

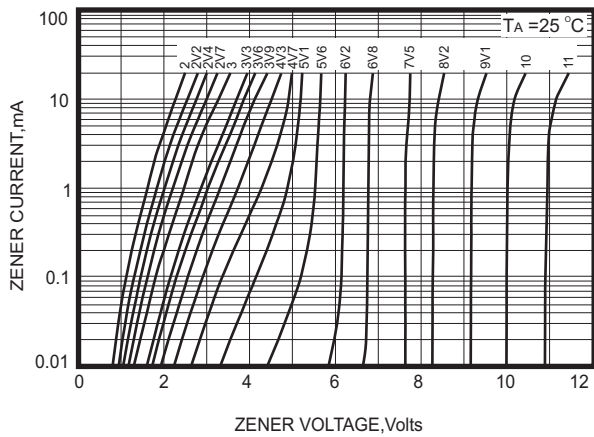

Fig.8 ZENER VOLTAGE VERSUS ZENER CURRENT

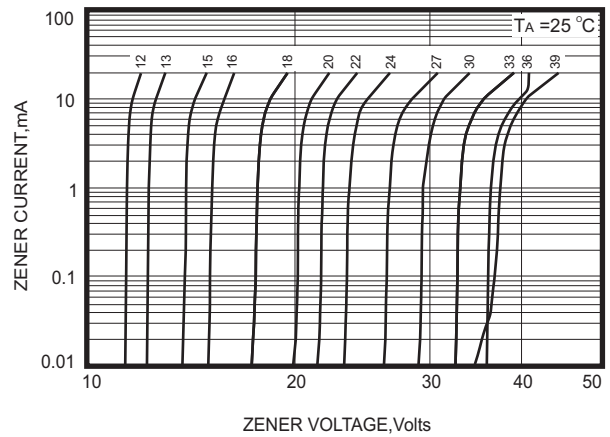
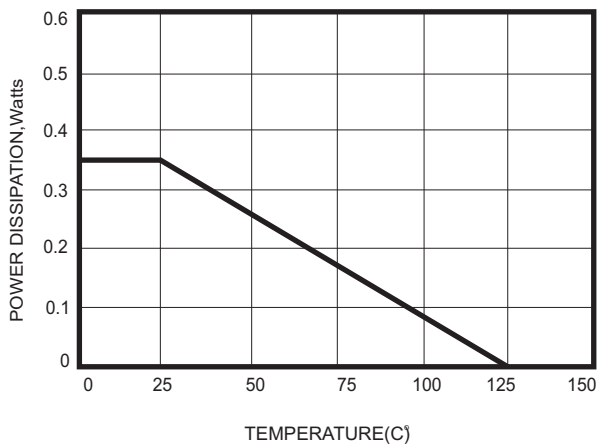
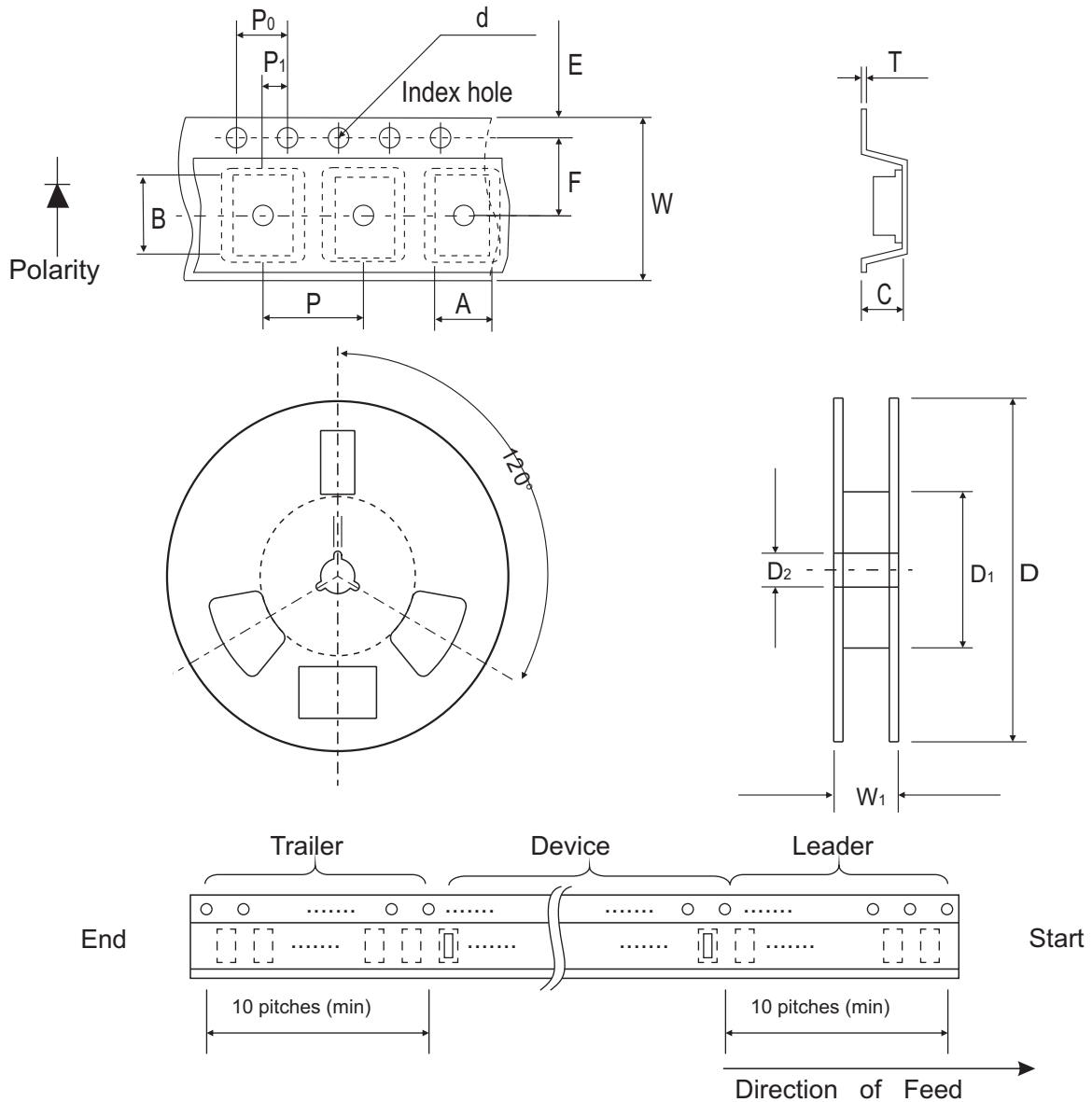

Fig.9 STEADY STATE POWER DERATING



Reel Taping Specification



| 1005 (SOD-323F) | SYMBOL | A | B | C | d | D | D ₁ | D ₂ |
|--------------------|--------|---------------|---------------|---------------|---------------|--------------|----------------|----------------|
| | (mm) | 1.55 ± 0.10 | 2.65 ± 0.10 | 1.05 ± 0.10 | 1.55 ± 0.05 | 178 ± 1 | 60.0 MIN. | 13.0 ± 0.20 |
| | (inch) | 0.061 ± 0.004 | 0.104 ± 0.004 | 0.041 ± 0.004 | 0.061 ± 0.002 | 7.008 ± 0.04 | 2.362 MIN. | 0.512 ± 0.008 |

| 1005 (SOD-323F) | SYMBOL | E | F | P | P ₀ | P ₁ | T | W | W ₁ |
|--------------------|--------|---------------|---------------|---------------|----------------|----------------|---------------|---------------|----------------|
| | (mm) | 1.75 ± 0.10 | 3.50 ± 0.05 | 4.00 ± 0.10 | 4.00 ± 0.10 | 2.00 ± 0.05 | 0.23 ± 0.05 | 8.00 ± 0.20 | 13.5 MAX. |
| | (inch) | 0.069 ± 0.004 | 0.138 ± 0.002 | 0.157 ± 0.004 | 0.157 ± 0.004 | 0.079 ± 0.002 | 0.009 ± 0.002 | 0.315 ± 0.008 | 0.531 MAX. |

Company reserves the right to improve product design, functions and reliability without notice.

REV:B

Suggested PAD Layout

| SIZE | 1005/SOD-323F | |
|------|---------------|--------|
| | (mm) | (inch) |
| A | 2.10 | 0.083 |
| B | 1.20 | 0.047 |
| C | 1.20 | 0.047 |
| D | 3.30 | 0.130 |
| E | 0.90 | 0.035 |

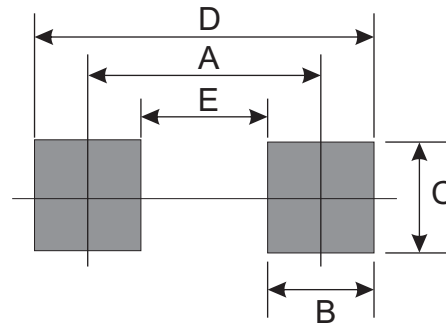

Standard Packaging

| Case Type | Qty per Reel | Reel Size |
|---------------|--------------|-----------|
| | (Pcs) | (inch) |
| 1005/SOD-323F | 4,000 | 7 |

Mouser Electronics

Authorized Distributor

Click to View Pricing, Inventory, Delivery & Lifecycle Information:

Comchip Technology:

[CZRF52C5V1](#) [CZRF52C5V6](#) [CZRF52C10-HF](#) [CZRF52C11-HF](#) [CZRF52C12-HF](#) [CZRF52C13-HF](#) [CZRF52C15-HF](#)
[CZRF52C16-HF](#) [CZRF52C18-HF](#) [CZRF52C20-HF](#) [CZRF52C22-HF](#) [CZRF52C24-HF](#) [CZRF52C27-HF](#) [CZRF52C2-](#)
[HF](#) [CZRF52C2V2-HF](#) [CZRF52C2V4-HF](#) [CZRF52C2V7-HF](#) [CZRF52C30-HF](#) [CZRF52C33-HF](#) [CZRF52C36-HF](#)
[CZRF52C39-HF](#) [CZRF52C3-HF](#) [CZRF52C3V3-HF](#) [CZRF52C3V6-HF](#) [CZRF52C3V9-HF](#) [CZRF52C4V3-HF](#)
[CZRF52C4V7-HF](#) [CZRF52C5V1-HF](#) [CZRF52C5V6-HF](#) [CZRF52C6V2-HF](#) [CZRF52C6V8-HF](#) [CZRF52C7V5-HF](#)
[CZRF52C8V2-HF](#) [CZRF52C9V1-HF](#) [CZRF52C2V2](#) [CZRF52C16](#) [CZRF52C4V3](#) [CZRF52C39](#) [CZRF52C30](#)
[CZRF52C22](#) [CZRF52C11](#) [CZRF52C7V5](#) [CZRF52C15](#) [CZRF52C20](#) [CZRF52C2V7](#) [CZRF52C3V6](#) [CZRF52C27](#)
[CZRF52C4V7](#) [CZRF52C33](#) [CZRF52C2V4](#) [CZRF52C9V1](#) [CZRF52C12](#) [CZRF52C13](#) [CZRF52C6V2](#) [CZRF52C8V2](#)
[CZRF52C3V9](#) [CZRF52C2](#) [CZRF52C6V8](#) [CZRF52C10](#) [CZRF52C24](#) [CZRF52C36](#) [CZRF52C18](#) [CZRF52C3V3](#)