

Figure 1  
Typical Forward Characteristics

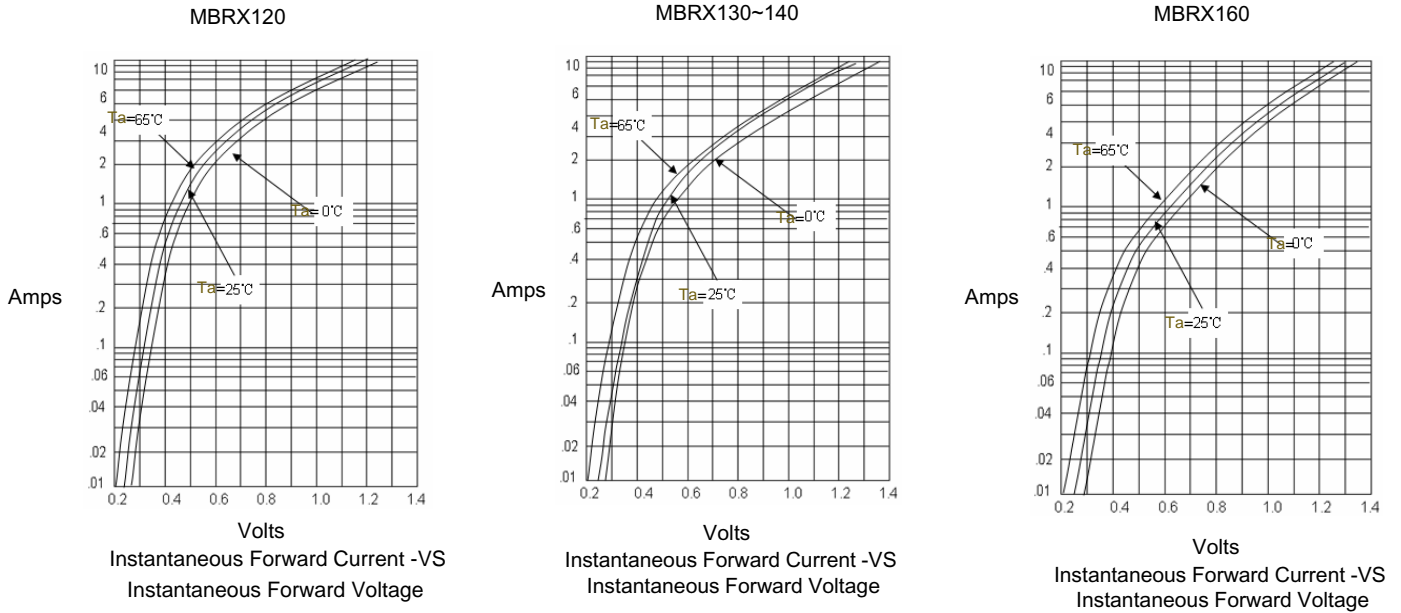
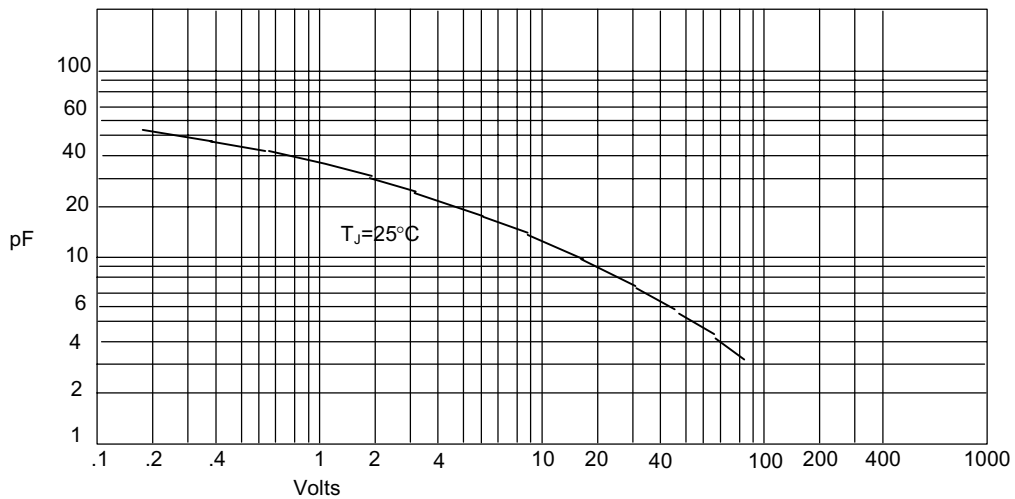
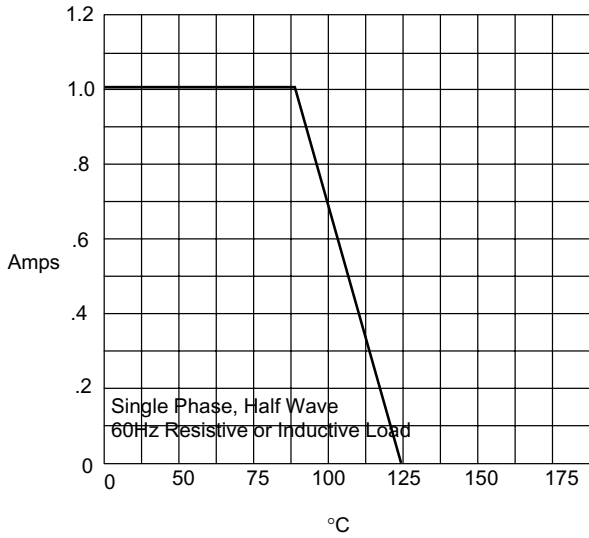

Figure 2  
Junction Capacitance



# MBRX120 thru MBRX160

Figure 3  
Forward Derating Curve



Average Forward Rectified Current - Amperes versus Ambient Temperature - °C

Figure 4  
Peak Forward Surge Current

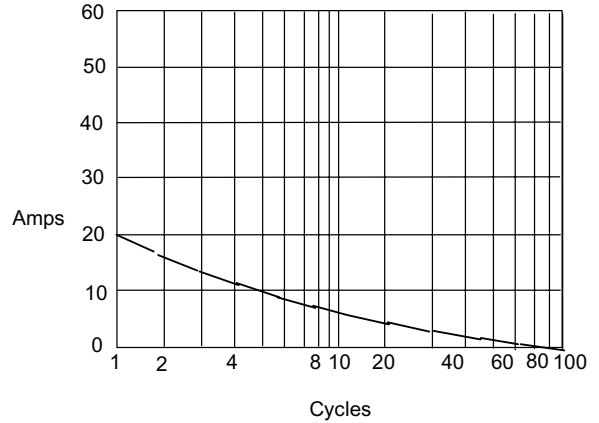

Peak Forward Surge Current - Amperes versus Number Of Cycles At 60Hz - Cycles

FIG. 5 - TYPICAL REVERSE CHARACTERISTICS

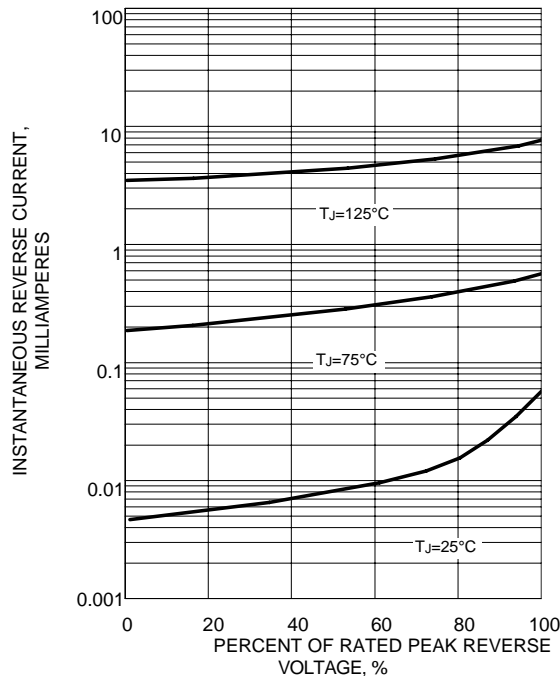

## **SURFACE MOUNT**

### **SURFACE MOUNT**

TYPE	TAPE SIZE (mm)	BULK/TUBE QUANTITY	7 INCH REEL QUANTITY	13 INCH REEL QUANTITY
SOD123	8	-----	3000	-----

### **TAPE DIMENSIONS AND ORIENTATION** 8mm Tape (in millimeters)

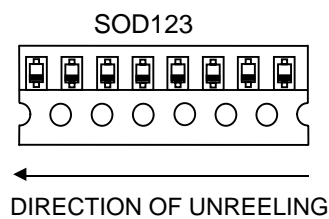

### **Embossed Carrier Tape Specifications** (8mm Tape)

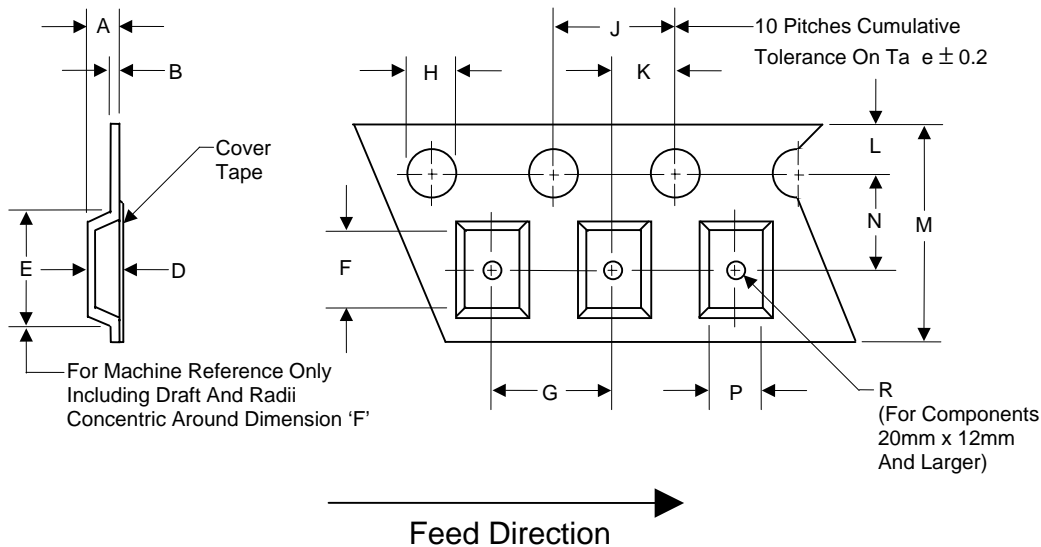

Tape Size	H	L	J	B (Max)	D, F, P	Constant Dimensions	
8	1.5 <sup>+0.1, -0.0</sup>	1.75±0.10	4.0±0.1	0.600	See Note 1		
Tape Size	E (Max)	R (Min)	N	A (Max)	K	M	Variable Dimensions
8mm	4.2	1.0	3.5±0.05	2.4	2.0±0.05	8.0±0.30	
Tape Size	G						
	4.0±0.10		8.0±0.10		12.0±0.10		16.0±0.10
8mm	X						

## **SURFACE MOUNT**

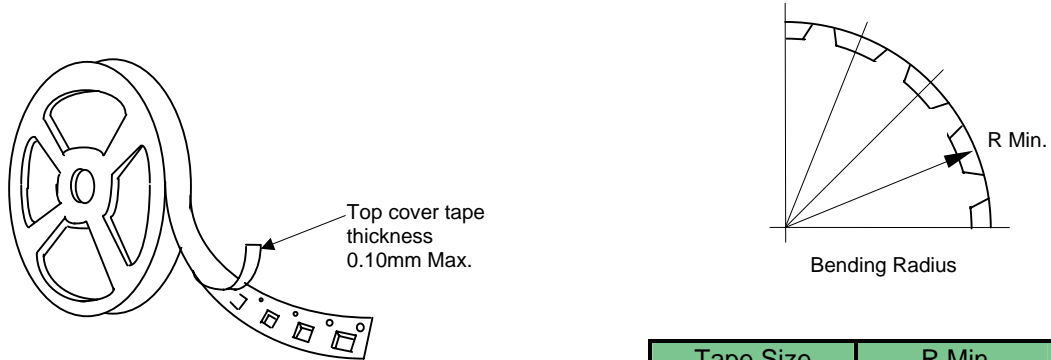

Tape Size	R Min.
8mm	25mm

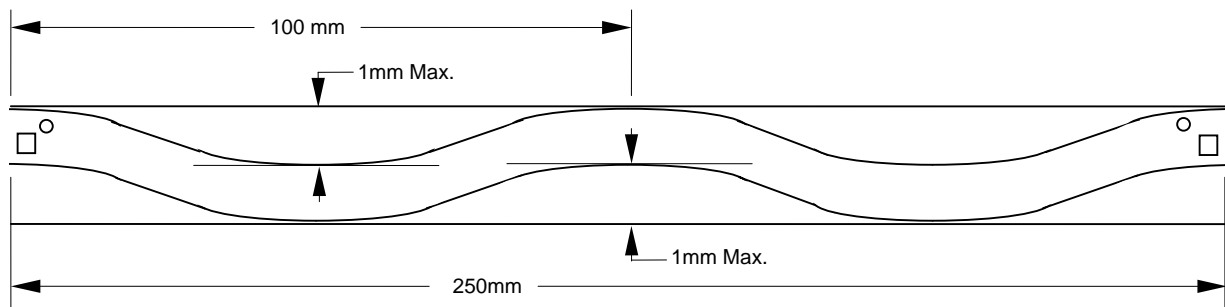

Camber (Top View)

Allowable camber to be 1mm/100mm non-accumulative over 250mm

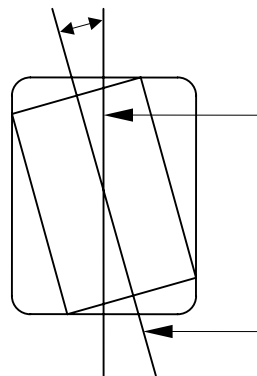



Micro Commercial Components

### Ordering Information :

Device	Packing
Part Number-TP	Tape&Reel: 3Kpcs/Reel

Note : Adding "-HF" suffix for halogen free, eg. Part Number-TP-HF

#### \*\*\*IMPORTANT NOTICE\*\*\*

**Micro Commercial Components Corp.** reserves the right to make changes without further notice to any product herein to make corrections, modifications , enhancements , improvements , or other changes . **Micro Commercial Components Corp .** does not assume any liability arising out of the application or use of any product described herein; neither does it convey any license under its patent rights ,nor the rights of others . The user of products in such applications shall assume all risks of such use and will agree to hold **Micro Commercial Components Corp .** and all the companies whose products are represented on our website, harmless against all damages.

#### \*\*\*LIFE SUPPORT\*\*\*

MCC's products are not authorized for use as critical components in life support devices or systems without the express written approval of Micro Commercial Components Corporation.

#### \*\*\*CUSTOMER AWARENESS\*\*\*

Counterfeiting of semiconductor parts is a growing problem in the industry. Micro Commercial Components (MCC) is taking strong measures to protect ourselves and our customers from the proliferation of counterfeit parts. MCC strongly encourages customers to purchase MCC parts either directly from MCC or from Authorized MCC Distributors who are listed by country on our web page cited below. Products customers buy either from MCC directly or from Authorized MCC Distributors are genuine parts, have full traceability, meet MCC's quality standards for handling and storage. **MCC will not provide any warranty coverage or other assistance for parts bought from Unauthorized Sources.** MCC is committed to combat this global problem and encourage our customers to do their part in stopping this practice by buying direct or from authorized distributors.

# Mouser Electronics

Authorized Distributor

Click to View Pricing, Inventory, Delivery & Lifecycle Information:

[Micro Commercial Components \(MCC\):](#)

[MBRX130-TP](#) [MBRX160-TP](#) [MBRX140-TP](#) [MBRX120-TP](#)