

TDA7240A

PIN CONNECTION (Top view)

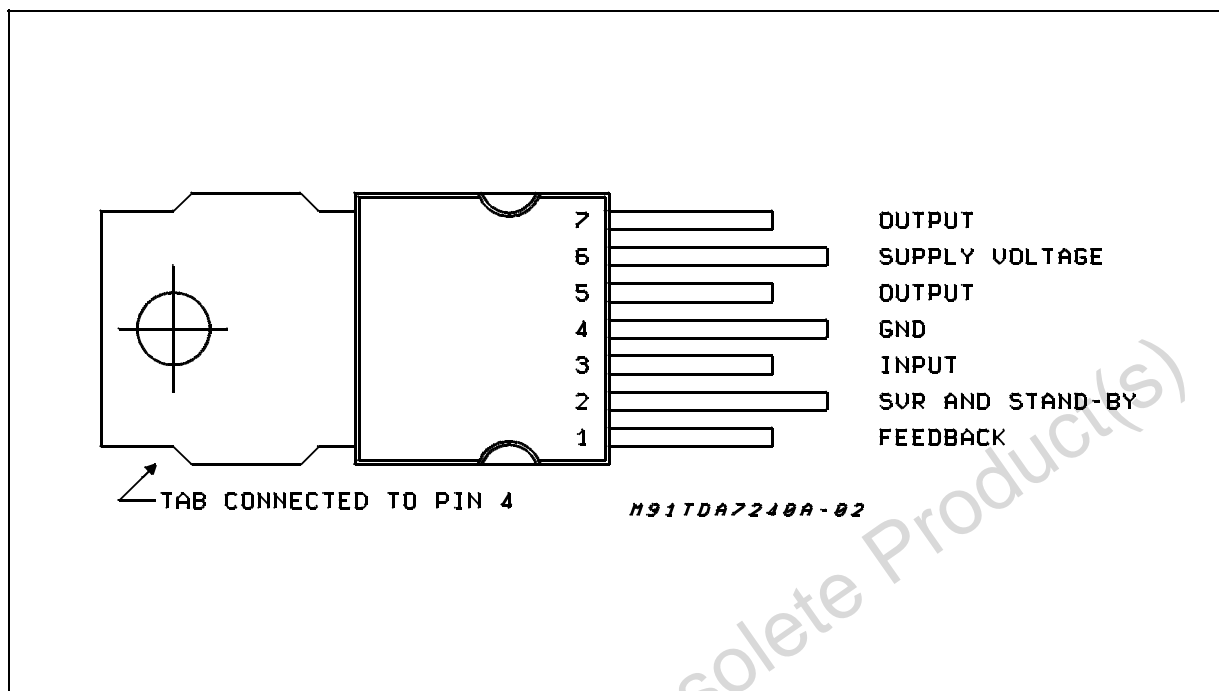

ABSOLUTE MAXIMUM RATINGS

Symbol	Parameter	Value	Unit
V_s	Operating Supply Voltage	18	V
V_s	DC Supply Voltage	28	V
V_s	Peak Supply Voltage (for 50ms)	40	V
I_o (*)	Peak Output Current (non repetitive $t = 0.1\text{ms}$)	4.5	A
I_o (*)	Peak Output Current (repetitive $f \geq 10\text{Hz}$)	3.5	A
P_{tot}	Power Dissipation at $T_{case} = 85^\circ\text{C}$	16	W
T_{stg}, T_j	Storage and Junction Temperature	-40 to 150	$^\circ\text{C}$

(*) Internally limited

THERMAL DATA

Symbol	Parameter	Value	Unit
$R_{th\ j-case}$	Thermal Resistance Junction-case	Max. 4	V

ELECTRICAL CHARACTERISTICS (refer to the circuit of fig. 1, $T_{amb} = 25^{\circ}\text{C}$, $R_{th}(\text{heatsink}) = 4^{\circ}\text{C/W}$, $V_s = 14.4\text{V}$)

Symbol	Parameter	Test Conditions	Min.	Typ.	Max.	Unit
V_s	Supply Voltage				18	V
V_{os}	Output Offset Voltage				150	mV
I_d	Total Quiescent Current	$R_L = 4\Omega$		65	120	mA
P_o	Output Power	$f = 1\text{kHz}; d = 10\%$ $R_L = 4\Omega$ $R_L = 8\Omega$	18 10	20 12		W W
d	Distortion	$R_L = 4\Omega$ $P_o = 50\text{mW to } 12\text{W}$ $f = 1\text{kHz}$		0.1	0.5	%
		$R_L = 8\Omega$ $P_o = 50\text{mW to } 12\text{W}$ $f = 1\text{kHz}$		0.05	0.5	%
GV	Voltage Gain	$f = 1\text{KHz}$	39.5	40	40.5	dB
SVR	Supply Voltage Rejection	$f = 100\text{Hz}$ $R_g = 10\text{K}\Omega$	35	40		dB
E_N	Total Input Noise	$R_g = 10\text{K}\Omega$ (*) (**)		2 3	10	μV μV
η	Efficiency	$R_L = 4\Omega$ $f = 1\text{KHz}$		65		%
I_{sb}	Stand-by Current			200		μA
R_i	Input Resistance	$f = 1\text{kHz}$	70			$\text{k}\Omega$
V_i	Input Sensitivity	$f = 1\text{kHz}; P_o = 2\text{W}; R_L = 4\Omega$		28		mV
f_L	Low Frequency Roll Off (-3dB)	$P_o = 15\text{W}; R_L = 4\Omega$			30	Hz
f_H	High Frequency Roll Off (-3dB)	$P_o = 15\text{W}; R_L = 4\Omega$	25			kHz
A_s	Stand-by Attenuation	$V_o = 2\text{Vrms}$	70	90		dB
$V_{TH}(\text{pin2})$	Stand-by Threshold				1	V

(*) B= Curve A

(**) B = 22Hz to 22 KHz

Figure 2 : P.C. Board and Components layout of the Circuit of Fig. 1.(1:1scale)

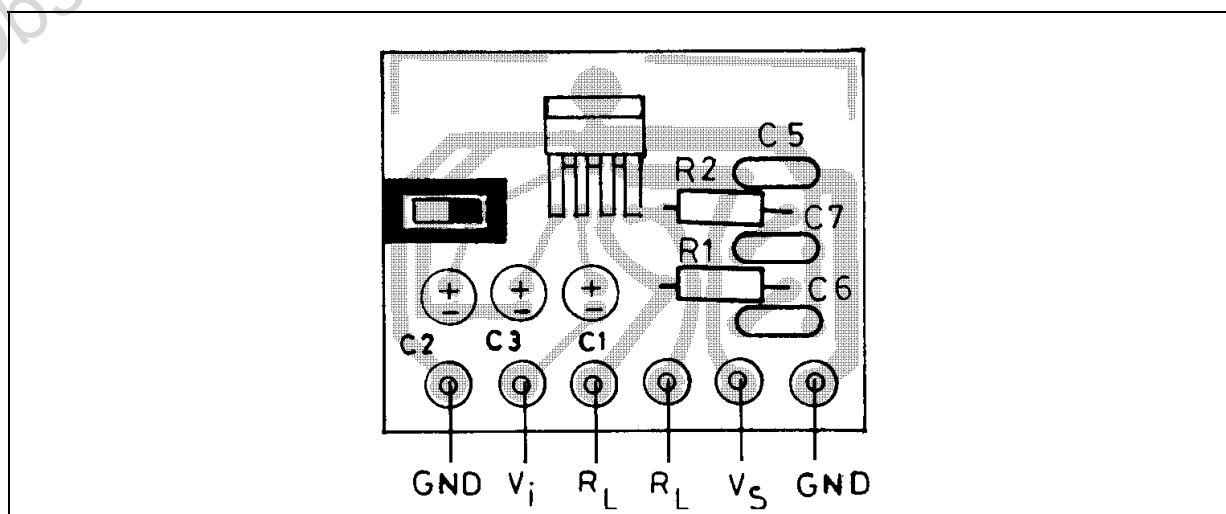

TDA7240A

APPLICATION SUGGESTION

The recommended values of the components are those shown on application circuit of Fig. 1. Different values can be used, the following table can help the designer.

Component	Recommended Value	Purpose	Larger Than	Smaller Than
R1, R2	2.2Ω	Frequency Stability	Danger of High Frequency Oscillation	
C1	1μF	Input DC Decoupling	Higher Turn On and Stand-by Delay	Higher Turn On Pop. Higher Low Frequency Cutoff
C2	22μF	Ripple Rejection	Increase of SVR Increase of the Turn On Delay	Degradation of SVR
C3	22μF	Feedback low Frequency Cutoff		Higher Low Frequency Cutoff
C6, C7	0.22μF	Frequency Stability		Danger of Oscillation
C4	220μF	Supply Filter		Danger of Oscillation
C5	0.1μF	Supply Bypass		Danger of Oscillation

Figure 3 : Output Power vs. Supply Voltage.

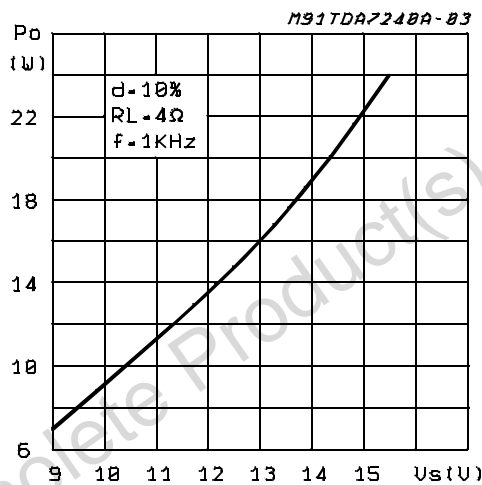

Figure 4 : Distortion vs. Output Power.

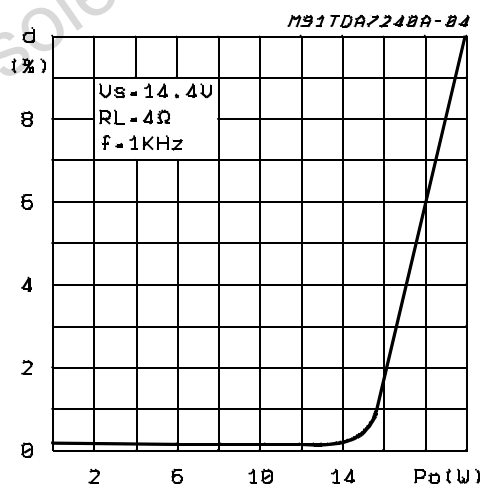

Figure 5 : Output Power vs. Supply voltage.

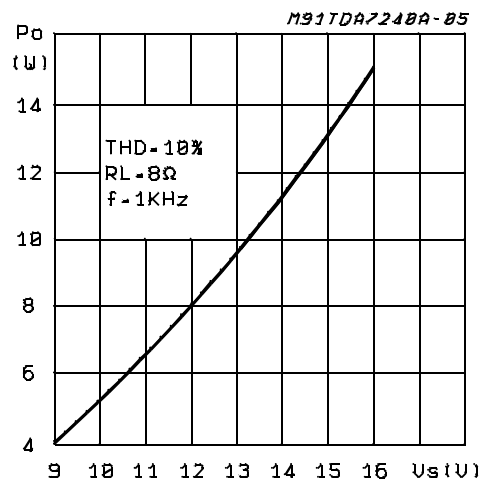

Figure 6 : Distortion vs. Output Power.

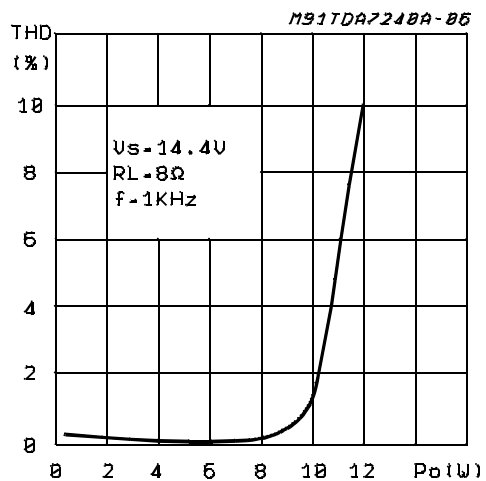

Figure 7 : Distortion vs. Frequency.

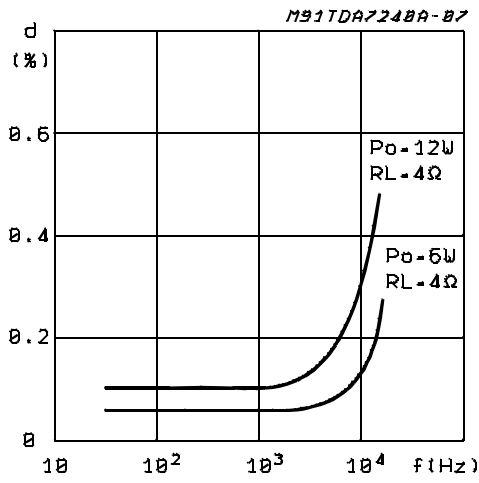

Figure 8 : Supply Voltage Rejection vs. Frequency.

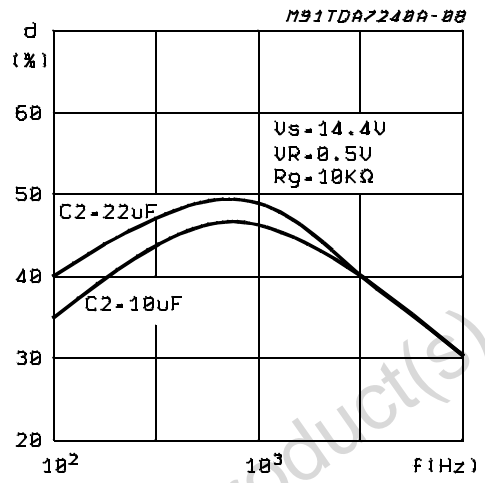

Figure 9 : Power Dissipation and Efficiency vs. Output Power.

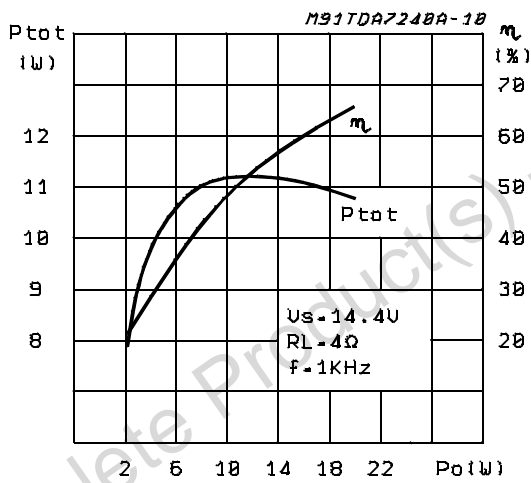
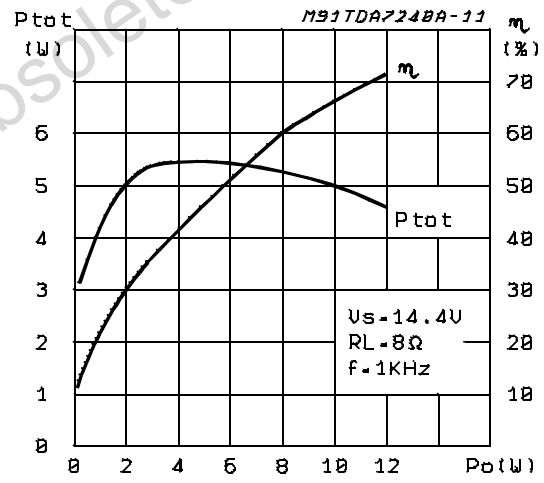

Figure 10 : Power Dissipation and Efficiency vs. Output Power.



TDA7240A

DIM.	mm			inch		
	MIN.	TYP.	MAX.	MIN.	TYP.	MAX.
A			4.8			0.189
C			1.37			0.054
D	2.4		2.8	0.094		0.110
D1	1.2		1.35	0.047		0.053
E	0.35		0.55	0.014		0.022
E1	0.7		0.97	0.028		0.038
F	0.6		0.8	0.024		0.031
F1			0.9			0.035
G	2.34	2.54	2.74	0.095	0.100	0.105
G1	4.88	5.08	5.28	0.193	0.200	0.205
G2	7.42	7.62	7.82	0.295	0.300	0.307
H2			10.4			0.409
H3	10.05		10.4	0.396		0.409
L	16.7	16.9	17.1	0.657	0.668	0.673
L1		14.92			0.587	
L2	21.24	21.54	21.84	0.386	0.848	0.860
L3	22.27	22.52	22.77	0.877	0.891	0.896
L4			1.29			0.051
L5	2.6	2.8	3	0.102	0.110	0.118
L6	15.1	15.5	15.8	0.594	0.610	0.622
L7	6	6.35	6.6	0.236	0.250	0.260
L9		0.2			0.008	
M	2.55	2.8	3.05	0.100	0.110	0.120
M1	4.83	5.08	5.33	0.190	0.200	0.210
V4	40° (typ.)					
Dia	3.65		3.85	0.144		0.152

OUTLINE AND MECHANICAL DATA

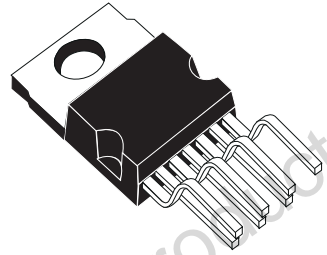

Heptawatt V

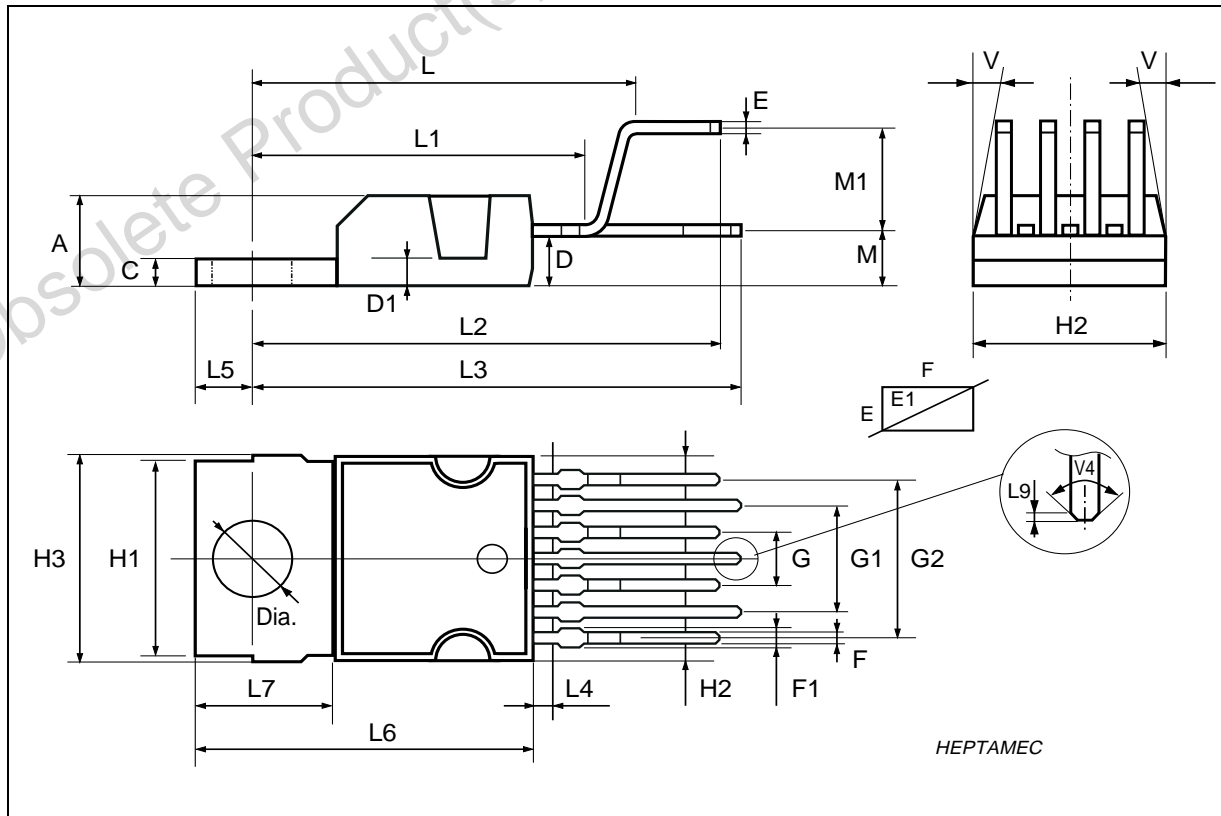

DIM.	mm			inch		
	MIN.	TYP.	MAX.	MIN.	TYP.	MAX.
A			4.8			0.189
C			1.37			0.054
D	2.4		2.8	0.094		0.110
D1	1.2		1.35	0.047		0.053
E	0.35		0.55	0.014		0.022
F	0.6		0.8	0.024		0.031
F1			0.9			0.035
G	2.41	2.54	2.67	0.095	0.100	0.105
G1	4.91	5.08	5.21	0.193	0.200	0.205
G2	7.49	7.62	7.8	0.295	0.300	0.307
H2			10.4			0.409
H3	10.05		10.4	0.396		0.409
L		14.2			0.559	
L1		4.4			0.173	
L2		15.8			0.622	
L3		5.1			0.201	
L5	2.6		3	0.102		0.118
L6	15.1		15.8	0.594		0.622
L7	6		6.6	0.236		0.260
L9		4.44			0.175	
Dia	3.65		3.85	0.144		0.152

OUTLINE AND MECHANICAL DATA

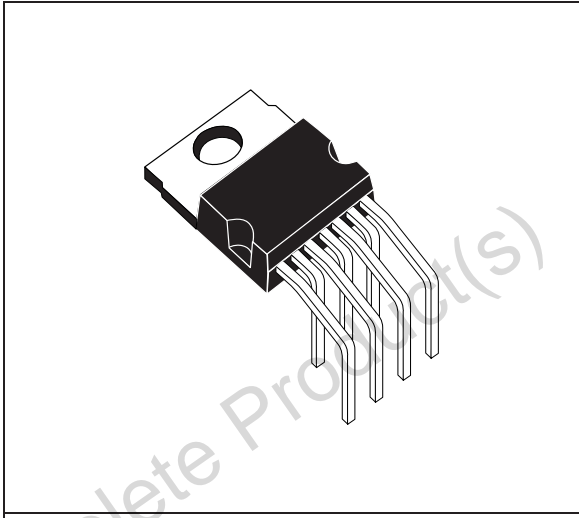

Heptawatt H

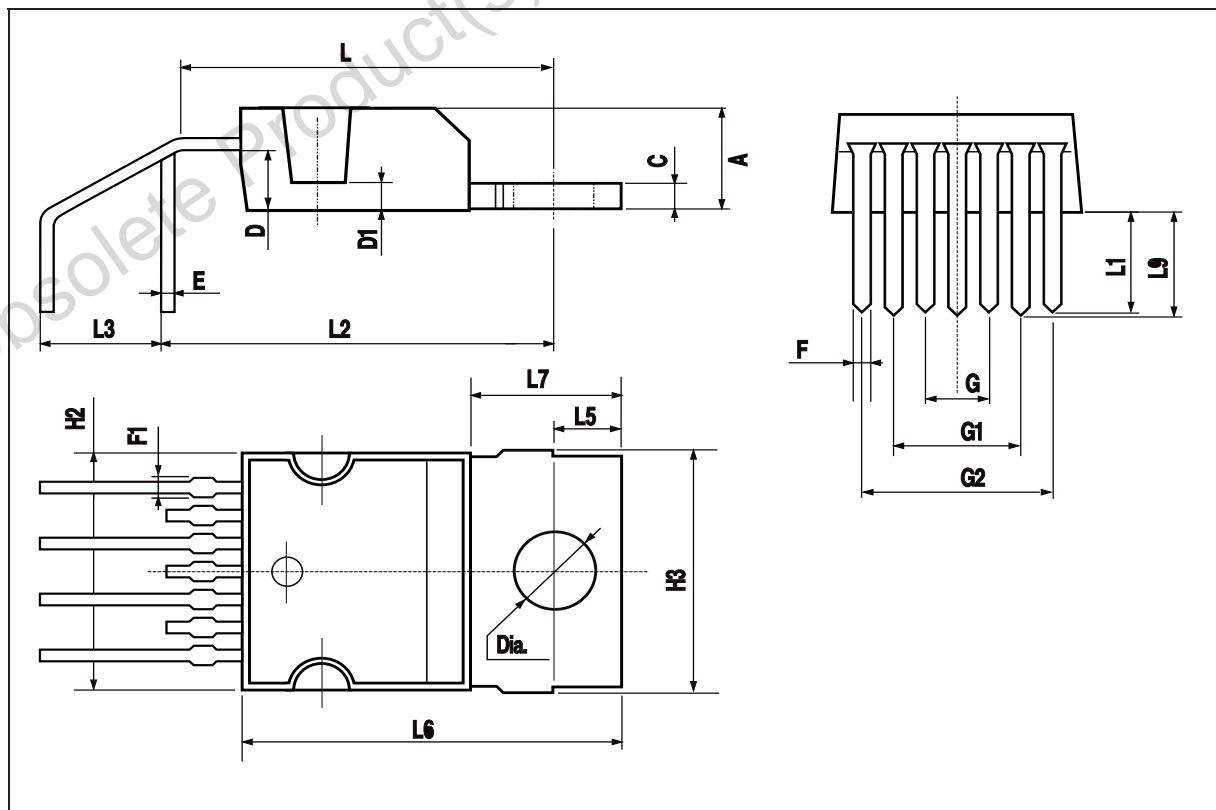

Obsolete Product(s) - Obsolete Product(s)

Information furnished is believed to be accurate and reliable. However, STMicroelectronics assumes no responsibility for the consequences of use of such information nor for any infringement of patents or other rights of third parties which may result from its use. No license is granted by implication or otherwise under any patent or patent rights of STMicroelectronics. Specification mentioned in this publication are subject to change without notice. This publication supersedes and replaces all information previously supplied. STMicroelectronics products are not authorized for use as critical components in life support devices or systems without express written approval of STMicroelectronics.

The ST logo is a registered trademark of STMicroelectronics
HEPTAWATT™ is a Trademark of SGS-THOMSON Microelectronics
© 1998 STMicroelectronics – Printed in Italy – All Rights Reserved
STMicroelectronics GROUP OF COMPANIES

Australia - Brazil - Canada - China - France - Germany - Italy - Japan - Korea - Malaysia - Malta - Mexico - Morocco - The Netherlands - Singapore - Spain - Sweden - Switzerland - Taiwan - Thailand - United Kingdom - U.S.A.

<http://www.st.com>

Mouser Electronics

Authorized Distributor

Click to View Pricing, Inventory, Delivery & Lifecycle Information:

[STMicroelectronics:](#)

[TDA7240AV](#) [TDA7240AH](#)