

Rating and Characteristic Curves (P6KE-G Series)

Fig.1 - Pulse Derating Curve

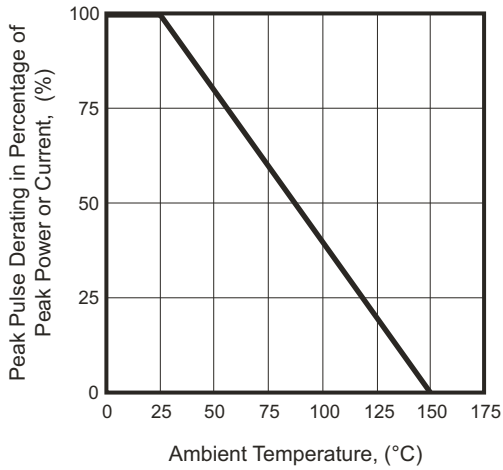

Fig.2 - Maximum Non-Repetitive Surge Current

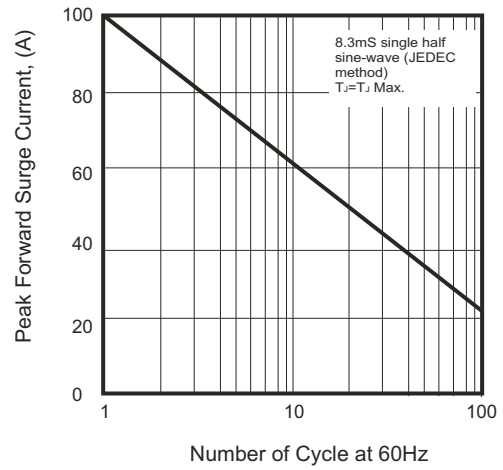

Fig.3 - Steady State Power Derating Curve

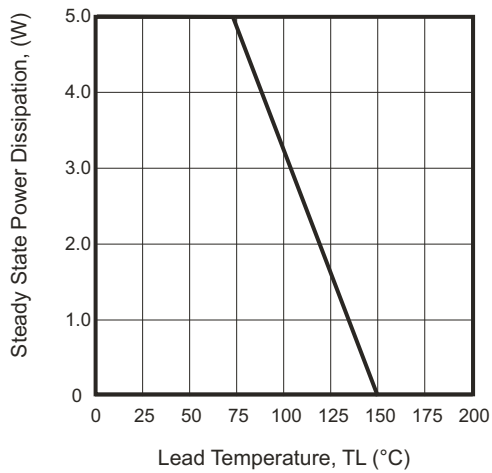

Fig.4 - Peak Pulse Power Rating Curve

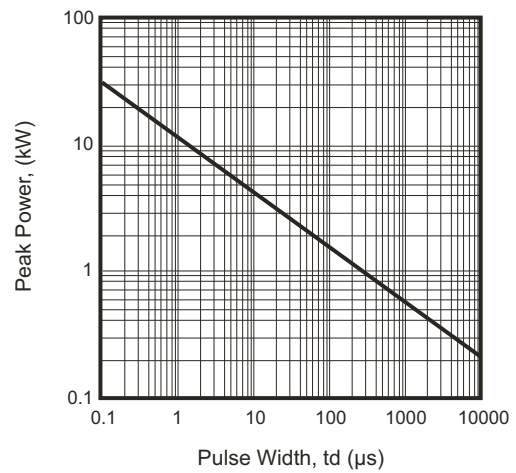

Fig.5 - Pulse Waveform

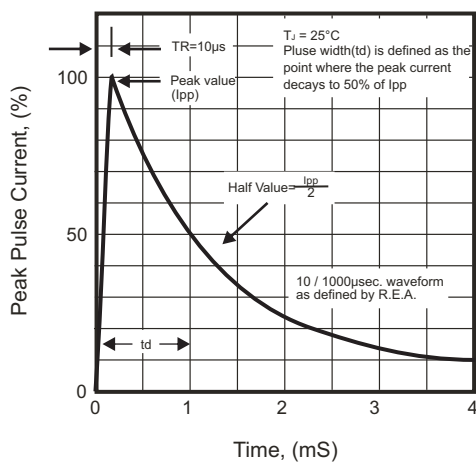
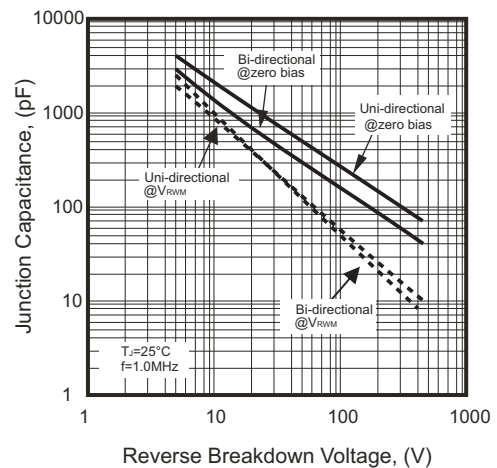

Fig.6 - Typical Junction Capacitance



Company reserves the right to improve product design, functions and reliability without notice.

600W Transient Voltage Suppressor

Electrical Characteristics (P6KE-G Series)

| Part No. | Breakdown voltage VBR @ IT | | | Maximum Reverse Leakage @VRWM IR (uA) | Working Peak Reverse Voltage VRWM (V) | Maximum Reverse Surge Current IPP (A) | Maximum Clamping Voltage @IPP Vc (V) | Marking Code | |
|---------------|-------------------------------|----------|---------|---|--|--|--|--------------|-----------|
| | Min. (V) | Max. (V) | IT (mA) | | | | | UNI | BI |
| P6KE6.8(C)A-G | 6.46 | 7.14 | 10 | 1000 | 5.8 | 57.14 | 10.5 | P6KE6.8A | P6KE6.8CA |
| P6KE7.5(C)A-G | 7.13 | 7.88 | 10 | 500 | 6.4 | 53.10 | 11.3 | P6KE7.5A | P6KE7.5CA |
| P6KE8.2(C)A-G | 7.79 | 8.61 | 10 | 200 | 7.0 | 49.59 | 12.1 | P6KE8.2A | P6KE8.2CA |
| P6KE9.1(C)A-G | 8.65 | 9.56 | 1 | 50 | 7.8 | 44.78 | 13.4 | P6KE9.1A | P6KE9.1CA |
| P6KE10(C)A-G | 9.50 | 10.50 | 1 | 10 | 8.6 | 41.38 | 14.5 | P6KE10A | P6KE10CA |
| P6KE11(C)A-G | 10.45 | 11.55 | 1 | 5.0 | 9.4 | 38.46 | 15.6 | P6KE11A | P6KE11CA |
| P6KE12(C)A-G | 11.40 | 12.60 | 1 | 5.0 | 10.2 | 35.93 | 16.7 | P6KE12A | P6KE12CA |
| P6KE13(C)A-G | 12.35 | 13.65 | 1 | 1 | 11.1 | 32.97 | 18.2 | P6KE13A | P6KE13CA |
| P6KE15(C)A-G | 14.25 | 15.75 | 1 | 1 | 12.8 | 28.30 | 21.2 | P6KE15A | P6KE15CA |
| P6KE16(C)A-G | 15.20 | 16.80 | 1 | 1 | 13.6 | 26.67 | 22.5 | P6KE16A | P6KE16CA |
| P6KE18(C)A-G | 17.10 | 18.90 | 1 | 1 | 15.3 | 23.81 | 25.2 | P6KE18A | P6KE18CA |
| P6KE20(C)A-G | 19.00 | 21.00 | 1 | 1 | 17.1 | 21.66 | 27.7 | P6KE20A | P6KE20CA |
| P6KE22(C)A-G | 20.90 | 23.10 | 1 | 1 | 18.8 | 19.61 | 30.6 | P6KE22A | P6KE22CA |
| P6KE24(C)A-G | 22.80 | 25.20 | 1 | 1 | 20.5 | 18.07 | 33.2 | P6KE24A | P6KE24CA |
| P6KE27(C)A-G | 25.65 | 28.35 | 1 | 1 | 23.1 | 16.00 | 37.5 | P6KE27A | P6KE27CA |
| P6KE30(C)A-G | 28.50 | 31.50 | 1 | 1 | 25.6 | 14.49 | 41.4 | P6KE30A | P6KE30CA |
| P6KE33(C)A-G | 31.35 | 34.65 | 1 | 1 | 28.2 | 13.13 | 45.7 | P6KE33A | P6KE33CA |
| P6KE36(C)A-G | 34.20 | 37.80 | 1 | 1 | 30.8 | 12.02 | 49.9 | P6KE36A | P6KE36CA |
| P6KE39(C)A-G | 37.05 | 40.95 | 1 | 1 | 33.3 | 11.13 | 53.9 | P6KE39A | P6KE39CA |
| P6KE43(C)A-G | 40.85 | 45.15 | 1 | 1 | 36.8 | 10.12 | 59.3 | P6KE43A | P6KE43CA |
| P6KE47(C)A-G | 44.65 | 49.35 | 1 | 1 | 40.2 | 9.26 | 64.8 | P6KE47A | P6KE47CA |
| P6KE51(C)A-G | 48.45 | 53.55 | 1 | 1 | 43.6 | 8.56 | 70.1 | P6KE51A | P6KE51CA |
| P6KE56(C)A-G | 53.20 | 58.80 | 1 | 1 | 47.8 | 7.79 | 77.0 | P6KE56A | P6KE56CA |
| P6KE62(C)A-G | 58.90 | 65.10 | 1 | 1 | 53.0 | 7.06 | 85.0 | P6KE62A | P6KE62CA |
| P6KE68(C)A-G | 64.60 | 71.40 | 1 | 1 | 58.1 | 6.52 | 92.0 | P6KE68A | P6KE68CA |
| P6KE75(C)A-G | 71.25 | 78.75 | 1 | 1 | 64.1 | 5.83 | 103.0 | P6KE75A | P6KE75CA |
| P6KE82(C)A-G | 77.90 | 86.10 | 1 | 1 | 70.1 | 5.31 | 113.0 | P6KE82A | P6KE82CA |
| P6KE91(C)A-G | 86.45 | 95.55 | 1 | 1 | 77.8 | 4.80 | 125.0 | P6KE91A | P6KE91CA |
| P6KE100(C)A-G | 95.00 | 105.00 | 1 | 1 | 85.5 | 4.38 | 137.0 | P6KE100A | P6KE100CA |
| P6KE110(C)A-G | 104.50 | 115.50 | 1 | 1 | 94.0 | 3.95 | 152.0 | P6KE110A | P6KE110CA |
| P6KE120(C)A-G | 114.00 | 126.00 | 1 | 1 | 102.0 | 3.64 | 165.0 | P6KE120A | P6KE120CA |
| P6KE130(C)A-G | 123.50 | 136.50 | 1 | 1 | 111.0 | 3.35 | 179.0 | P6KE130A | P6KE130CA |
| P6KE150(C)A-G | 142.50 | 157.50 | 1 | 1 | 128.0 | 2.90 | 207.0 | P6KE150A | P6KE150CA |
| P6KE160(C)A-G | 152.00 | 168.00 | 1 | 1 | 136.0 | 2.74 | 219.0 | P6KE160A | P6KE160CA |
| P6KE170(C)A-G | 161.50 | 178.50 | 1 | 1 | 145.0 | 2.56 | 234.0 | P6KE170A | P6KE170CA |
| P6KE180(C)A-G | 171.00 | 189.00 | 1 | 1 | 154.0 | 2.44 | 246.0 | P6KE180A | P6KE180CA |
| P6KE200(C)A-G | 190.00 | 210.00 | 1 | 1 | 171.0 | 2.19 | 274.0 | P6KE200A | P6KE200CA |
| P6KE220(C)A-G | 209.00 | 231.00 | 1 | 1 | 185.0 | 1.83 | 328.0 | P6KE220A | P6KE220CA |
| P6KE250(C)A-G | 237.50 | 262.50 | 1 | 1 | 214.0 | 1.74 | 344.0 | P6KE250A | P6KE250CA |
| P6KE300(C)A-G | 285.00 | 315.00 | 1 | 1 | 256.0 | 1.45 | 414.0 | P6KE300A | P6KE300CA |
| P6KE350(C)A-G | 332.50 | 367.50 | 1 | 1 | 299.3 | 1.24 | 482.0 | P6KE350A | P6KE350CA |
| P6KE380(C)A-G | 361.00 | 399.00 | 1 | 1 | 324.9 | 1.14 | 524.4 | P6KE380A | P6KE380CA |
| P6KE400(C)A-G | 380.00 | 420.00 | 1 | 1 | 342.0 | 1.09 | 548.0 | P6KE400A | P6KE400CA |
| P6KE440(C)A-G | 418.00 | 462.00 | 1 | 1 | 376.2 | 0.99 | 607.2 | P6KE440A | P6KE440CA |
| P6KE500(C)A-G | 475.00 | 525.00 | 1 | 1 | 427.5 | 0.87 | 690.0 | P6KE500A | P6KE500CA |
| P6KE520(C)A-G | 494.00 | 546.00 | 1 | 1 | 444.6 | 0.84 | 717.6 | P6KE520A | P6KE520CA |
| P6KE550(C)A-G | 522.50 | 577.50 | 1 | 1 | 470.3 | 0.79 | 759.0 | P6KE550A | P6KE550CA |
| P6KE600(C)A-G | 570.00 | 630.00 | 1 | 1 | 513.0 | 0.72 | 828.0 | P6KE600A | P6KE600CA |

- Note: 1) Suffix A denotes 5% tolerance devices.
 2) Add suffix "C" or "CA" after part number to specify Bi-directional devices.
 3) For Bi-Directional devices having VR of 10 volts and under, the IR limit is double.

Company reserves the right to improve product design , functions and reliability without notice.

Taping Specification For Axial Lead Diodes

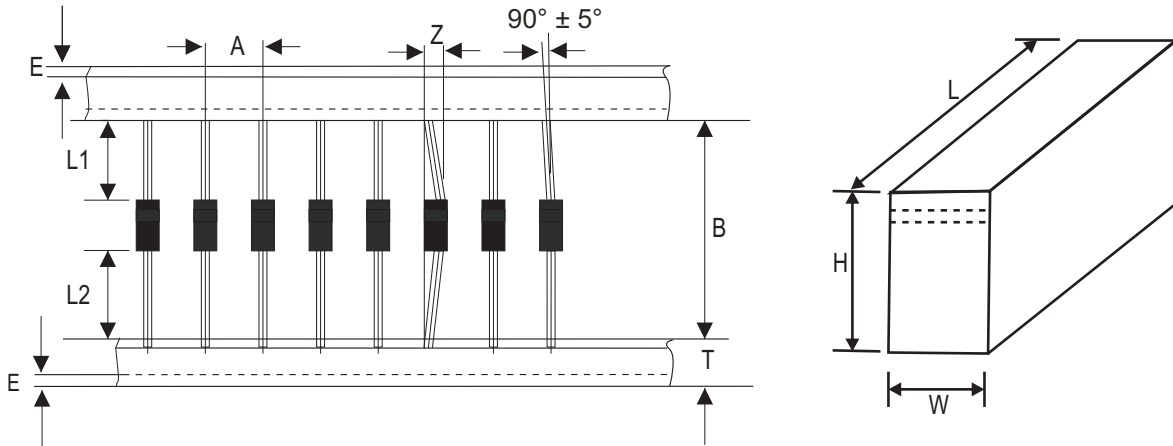

| DO-15 | SYMBOL | A | B | Z | T | E |
|-------|--------|---------------|---------------|-------------|---------------|-------------|
| | (mm) | 5.00 ± 0.50 | 52.00 ± 0.50 | 1.20 (max) | 6.00 ± 0.40 | 3.00 (max) |
| | (inch) | 0.197 ± 0.020 | 2.047 ± 0.020 | 0.047 (max) | 0.236 ± 0.016 | 0.118 (max) |

| DO-15 | SYMBOL | L1 | L2 | L | W | H |
|-------|--------|-------------|-------------|--------|-------|--------|
| | (mm) | 1.00 (max) | 1.00 (max) | 260.00 | 75.00 | 145.00 |
| | (inch) | 0.039 (max) | 0.039 (max) | 10.236 | 2.953 | 5.709 |

Standard Packaging

| Case Type | AMMO PACK | |
|-----------|----------------|-------------------|
| | BOX (pcs) | CARTON (pcs) |
| DO-15 | 3,000 | 30,000 |

Mouser Electronics

Authorized Distributor

Click to View Pricing, Inventory, Delivery & Lifecycle Information:

Comchip Technology:

[P6KE100A-G](#) [P6KE10A-G](#) [P6KE10CA-G](#) [P6KE110A-G](#) [P6KE11CA-G](#) [P6KE12A-G](#) [P6KE130A-G](#) [P6KE150A-G](#)
[P6KE15A-G](#) [P6KE15CA-G](#) [P6KE160A-G](#) [P6KE170A-G](#) [P6KE180A-G](#) [P6KE18CA-G](#) [P6KE200A-G](#) [P6KE20CA-G](#)
[P6KE220A-G](#) [P6KE22A-G](#) [P6KE22CA-G](#) [P6KE24A-G](#) [P6KE250A-G](#) [P6KE27A-G](#) [P6KE27CA-G](#) [P6KE300A-G](#)
[P6KE30A-G](#) [P6KE30CA-G](#) [P6KE33A-G](#) [P6KE33CA-G](#) [P6KE350A-G](#) [P6KE36A-G](#) [P6KE39A-G](#) [P6KE39CA-G](#)
[P6KE400A-G](#) [P6KE43A-G](#) [P6KE47A-G](#) [P6KE47CA-G](#) [P6KE51A-G](#) [P6KE51CA-G](#) [P6KE56CA-G](#) [P6KE6.8A-G](#)
[P6KE6.8CA-G](#) [P6KE62A-G](#) [P6KE62CA-G](#) [P6KE75CA-G](#) [P6KE220CA-G](#) [P6KE600A-G](#) [P6KE550A-G](#) [P6KE500CA-](#)
[G](#) [P6KE500A-G](#) [P6KE440A-G](#) [P6KE380CA-G](#) [P6KE520CA-G](#) [P6KE200CA-G](#) [P6KE520A-G](#) [P6KE380A-G](#)
[P6KE440CA-G](#) [P6KE550CA-G](#) [P6KE400CA-G](#) [P6KE300CA-G](#) [P6KE250CA-G](#) [P6KE350CA-G](#) [P6KE600CA-G](#)