

ORDERING INFORMATION

PART NO.	PACKING CODE	PACKING CODE SUFFIX	PACKAGE	PACKING
TST20UXXCW	C0	G	TO-220AB	50 / Tube

Note 1: "XX" defines voltage from 45V (TST20U45CW) to 60V (TST20U60CW)

EXAMPLE

PREFERRED PART NO.	PART NO.	PACKING CODE	PACKING CODE SUFFIX	DESCRIPTION
TST20U60CW C0G	TST20U60CW	C0	G	Green compound

RATINGS AND CHARACTERISTICS CURVES

($T_A=25^\circ\text{C}$ unless otherwise noted)

FIG.1 FORWARD CURRENT DERATING CURVE

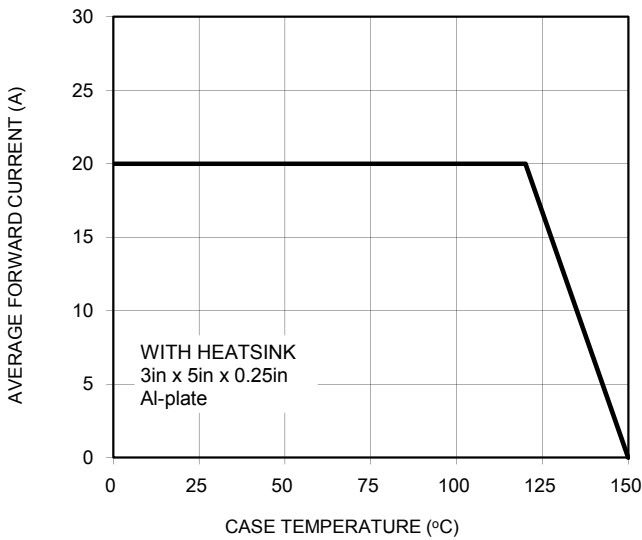

FIG. 2 TYPICAL FORWARD CHARACTERISTICS

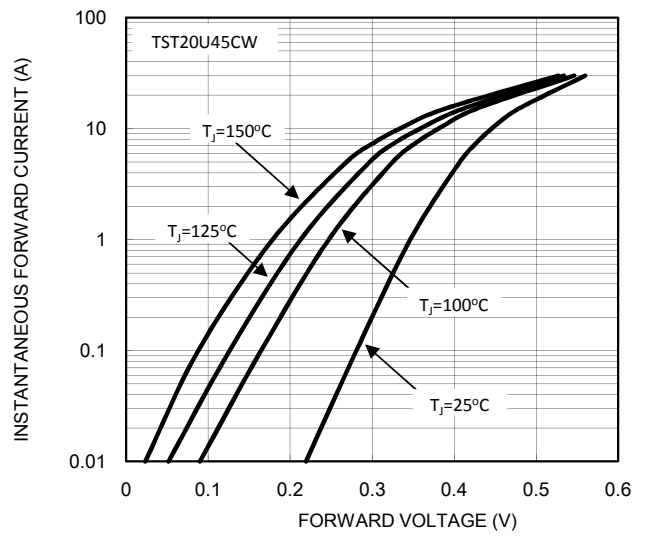

FIG. 3 TYPICAL FORWARD CHARACTERISTICS

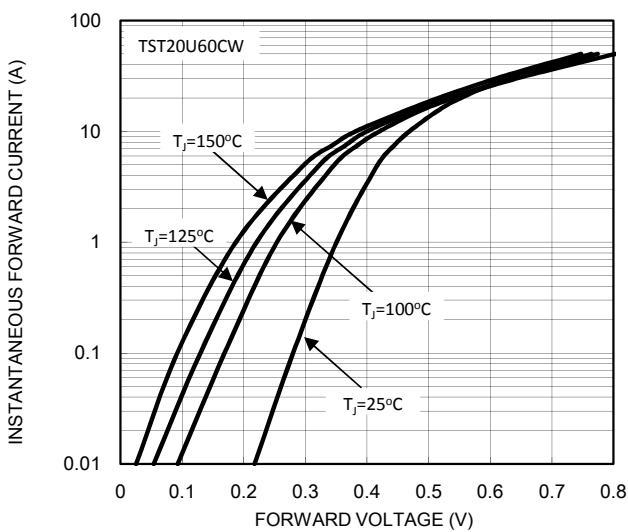

FIG. 4 TYPICAL REVERSE CHARACTERISTICS

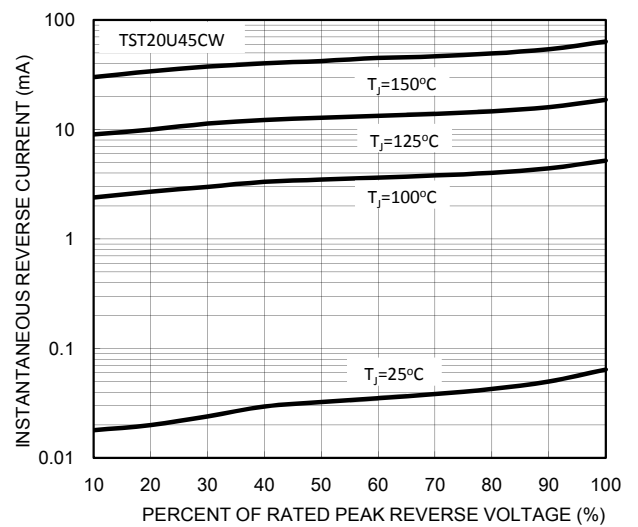

FIG. 5 TYPICAL REVERSE CHARACTERISTICS

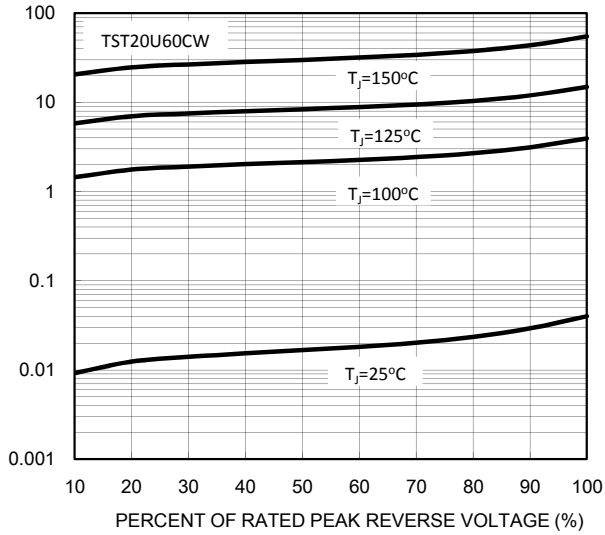

FIG. 6 TYPICAL JUNCTION CAPACITANCE

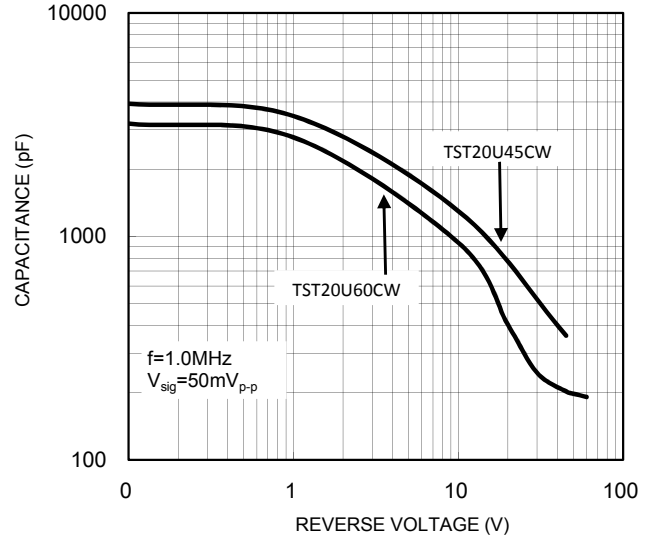
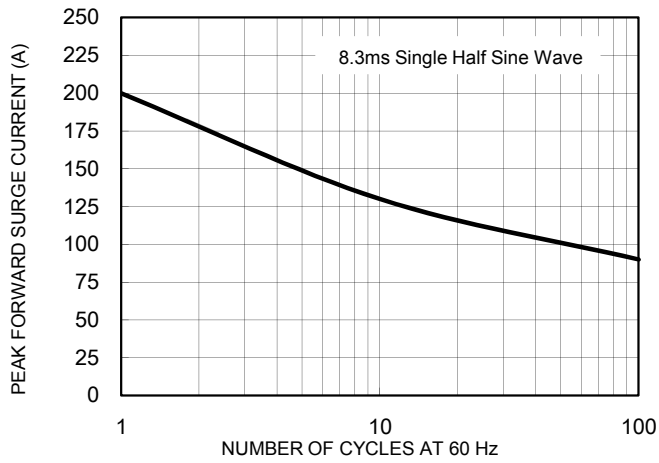
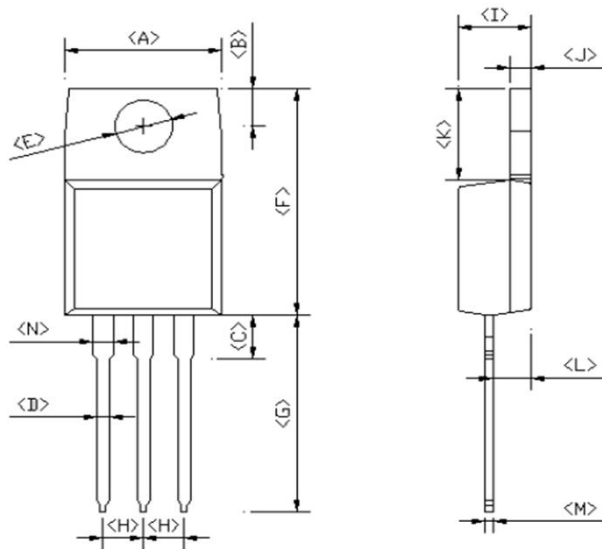

FIG. 7 MAXIMUM NON-REPETITIVE FORWARD SURGE CURRENT



PACKAGE OUTLINE DIMENSIONS

TO-220AB



DIM.	Unit (mm)		Unit (inch)	
	Min	Max	Min	Max
A	-	10.50	-	0.413
B	2.54	3.44	0.100	0.135
C	2.80	4.20	0.110	0.165
D	0.68	0.94	0.027	0.037
E	3.54	4.00	0.139	0.157
F	14.60	16.00	0.575	0.630
G	13.19	14.79	0.519	0.582
H	2.41	2.67	0.095	0.105
I	4.42	4.76	0.174	0.187
J	1.14	1.40	0.045	0.055
K	5.84	6.86	0.230	0.270
L	2.20	2.80	0.087	0.110
M	0.35	0.64	0.014	0.025
N	0.95	1.45	0.037	0.057

MARKING DIAGRAM

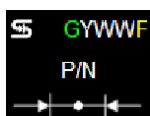

- P/N = Specific Device Code
- G = Green Compound
- YWW = Date Code
- F = Factory Code

Notice

Specifications of the products displayed herein are subject to change without notice. TSC or anyone on its behalf, assumes no responsibility or liability for any errors or inaccuracies.

Information contained herein is intended to provide a product description only. No license, express or implied, to any intellectual property rights is granted by this document. Except as provided in TSC's terms and conditions of sale for such products, TSC assumes no liability whatsoever, and disclaims any express or implied warranty, relating to sale and/or use of TSC products including liability or warranties relating to fitness for a particular purpose, merchantability, or infringement of any patent, copyright, or other intellectual property right.

The products shown herein are not designed for use in medical, life-saving, or life-sustaining applications. Customers using or selling these products for use in such applications do so at their own risk and agree to fully indemnify TSC for any damages resulting from such improper use or sale.

Mouser Electronics

Authorized Distributor

Click to View Pricing, Inventory, Delivery & Lifecycle Information:

[Taiwan Semiconductor:](#)

[TST20U45CW COG](#) [TST20U60CW COG](#) [TST20U45CW](#) [TST20U60CW](#)