

**ABSOLUTE MAXIMUM RATINGS<sup>1</sup>** (T<sub>A</sub> = 25°C)

SYMBOLS	PARAMETERS	UNITS	RATINGS
V <sub>CC</sub>	Supply Voltage	V	4.0
V <sub>PS</sub>	Power Save Voltage	V	4.0
P <sub>D</sub>	Power Dissipation <sup>2</sup>	mW	430
T <sub>OP</sub>	Operating Temperature	°C	-40 to +85
T <sub>STG</sub>	Storage Temperature	°C	-55 to +150

Notes:

1. Operation in excess of any one of these parameters may result in permanent damage.
2. Mounted on a 50 x 50 x 1.6 mm double copper clad epoxy glass PWB (T<sub>A</sub> = +85°C).

**PIN FUNCTIONS**

Pin No.	Symbol	Supply Voltage (V)	Pin Voltage (V)	Description	Equivalent Circuit
1	LO <sub>IN</sub>	—	2.6	LO input for the phase shifter.	
2	GND	0	—	Connect to ground with minimum inductance. Track length should be kept as short as possible.	
3	$\overline{\text{LO}}_{\text{IN}}$	—	2.6	Bypass of the LO input. This pin is grounded through a capacitor of approx. 30 pF.	
4	GND	0	—	Connect to ground with minimum inductance. Track length should be kept as short as possible.	
5	Q	V <sub>CC/2</sub> <sup>*1</sup>	—	Input for Q signal. If the I/Q input signals are single-ended, the maximum amplitude of the signal is 500 mVp-p.	
6	$\overline{\text{Q}}$	V <sub>CC/2</sub> <sup>*1</sup>	—	Input for Q signal. If the I/Q input signals are single-ended, $\overline{\text{Q}}$ should be DC biased at V <sub>CC</sub> /2. If the I/Q input signals are differential, the maximum amplitude of the signal is 250 mVp-p.	
7	$\overline{\text{I}}$	V <sub>CC/2</sub> <sup>*1</sup>	—	Input for I signal. If the I/Q input signals are single-ended, $\overline{\text{I}}$ should be DC biased at V <sub>CC</sub> /2. If the I/Q input signals are differential, the maximum amplitude of the signal is 250 mVp-p.	
8	I	V <sub>CC/2</sub> <sup>*1</sup>	—	Input for I signal. If the I/Q input signals are single-ended, the maximum amplitude of the signal is 500 mVp-p.	
9	GND	0	—	Connect to ground with minimum inductance. Track length should be kept as short as possible.	
10					
11	RF <sub>OUT</sub>	—	1.6	Output from the modulator. This is an emitter follower output. Connect approx. 15Ω in series to match to 50Ω.	

**RECOMMENDED OPERATING CONDITIONS**

SYMBOLS	PARAMETERS	UNITS	MIN	TYP	MAX
V <sub>CC</sub>	Supply Voltage	V	2.7	3.0	3.6
V <sub>PS</sub>	Power Save Voltage	V	0		V <sub>CC</sub>
T <sub>OP</sub>	Operating Temperature	°C	-40	+25	+85
P <sub>LO</sub>	LO Input Power Level	dBm	-15	-10	-7
f <sub>LOIN</sub>	LO Input Frequency	MHz	800	900	1000
f <sub>I/QIN</sub>	I/Q Input Frequency	MHz	DC		10
V <sub>I/QIN</sub>	I/Q Input Voltage	mVp-p			500 <sup>1</sup>
		mVp-p			250 <sup>2</sup>

Notes:

1. Single-ended Input.
2. Differential Input.

**PIN FUNCTIONS**

Pin No.	Symbol	Supply Voltage	Pin Voltage	Description	Equivalent Circuit						
12	GND	0	—	Connect to ground with minimum inductance. Track length should be kept as short as possible.							
13											
14	Vcc	2.7~3.6	—	Supply voltage pin for the modulator. An internal regulator helps keep the device stable against temperature or Vcc variations.							
15	GND	0	—	Connect to ground with minimum inductance. Track length should be kept as short as possible.							
16											
17	Power Save	Vps	—	Power save control pin can control the ON/SLEEP state with a bias as follows:  <table border="1" style="margin-left: auto; margin-right: auto;"> <tr> <th>Vps (V)</th> <th>STATE</th> </tr> <tr> <td>2.0 ~ 3.6</td> <td>ON</td> </tr> <tr> <td>0 ~ 0.8</td> <td>SLEEP</td> </tr> </table>	Vps (V)	STATE	2.0 ~ 3.6	ON	0 ~ 0.8	SLEEP	
Vps (V)	STATE										
2.0 ~ 3.6	ON										
0 ~ 0.8	SLEEP										
18	GND	0	—	Connect to ground with minimum inductance. Track length should be kept as short as possible.							
19	Vcc	2.7 ~ 3.6	—	Supply voltage pin for the modulator. An internal regulator helps keep the device stable against temperature or Vcc variations.							
20	GND	0	—	Connect to ground with minimum inductance. Track length should be kept as short as possible.							

\*1: Vcc/2 DC bias must be supplied to I,  $\bar{I}$ , Q,  $\bar{Q}$ .

**TYPICAL PERFORMANCE CURVES** Unless Otherwise Specified, (TA = +25°C, Vcc = Vps = 3 V, I/Q DC offset = 1.5 V, I/Q Input Signal = 500 mVp-p (Single ended), fI/Q = 2.625 kHz, fLOIN = 948 MHz, PLOIN = -10 dBm, <PDC>Transmission Speed: 42 kbps, RNYQ: a = 0.5.)

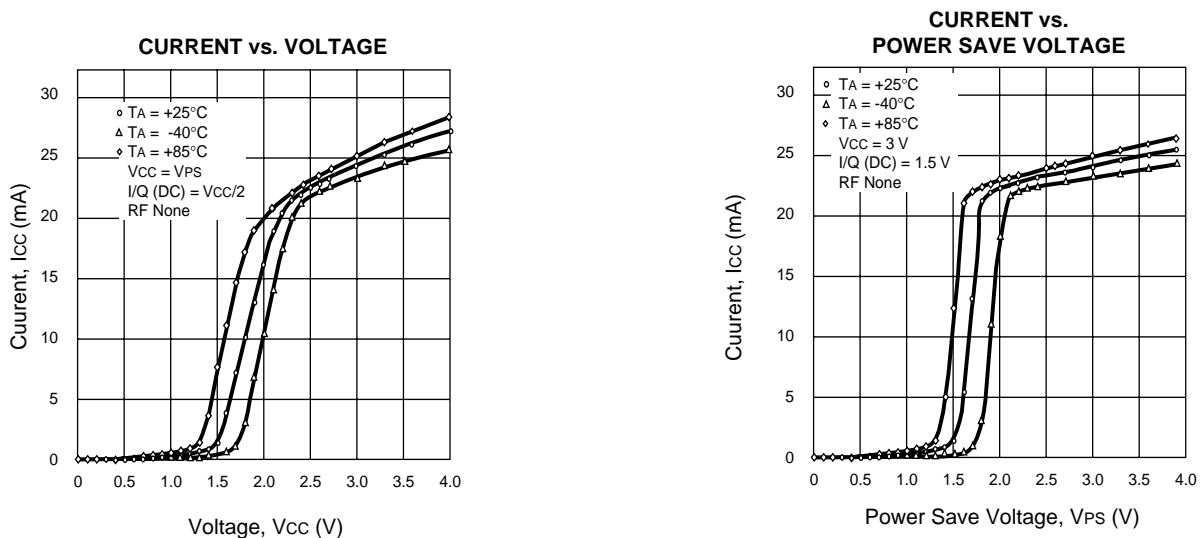

**TYPICAL PERFORMANCE CURVES** Unless Otherwise Specified, (TA = +25°C, VCC = VPS = 3 V, I/Q DC offset = 1.5 V, I/Q Input Signal = 500 mVp-p (Single ended), fI/Q = 2.625 kHz, fLOIN = 948 MHz, PLOIN = -10 dBm, <PDC>Transmission Speed: 42 kbps, RNYQ: a = 0.5.)

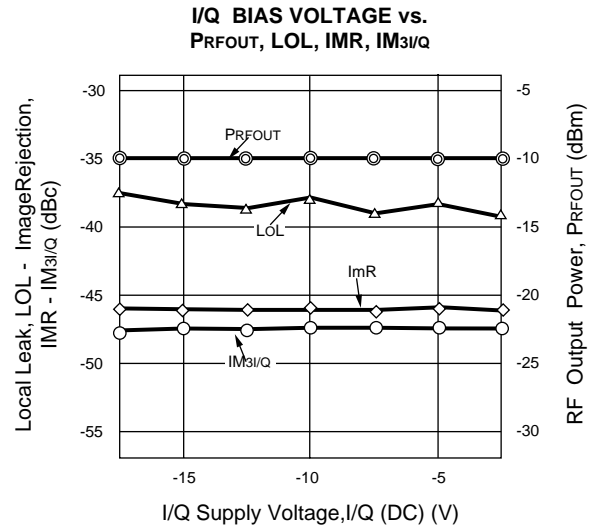
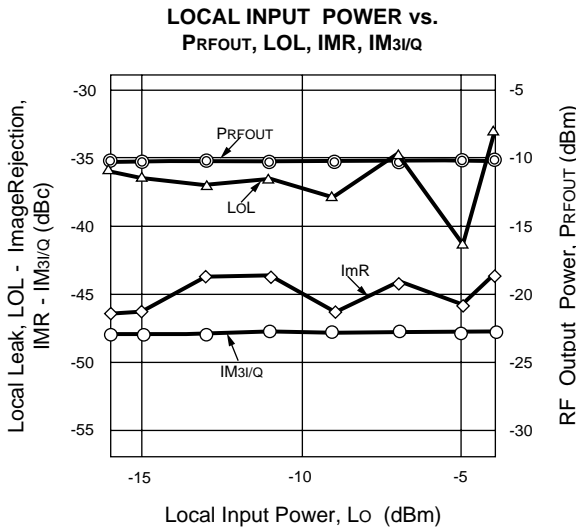
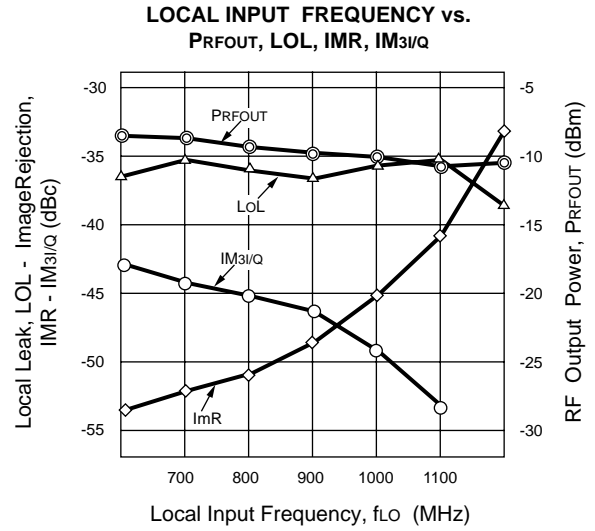
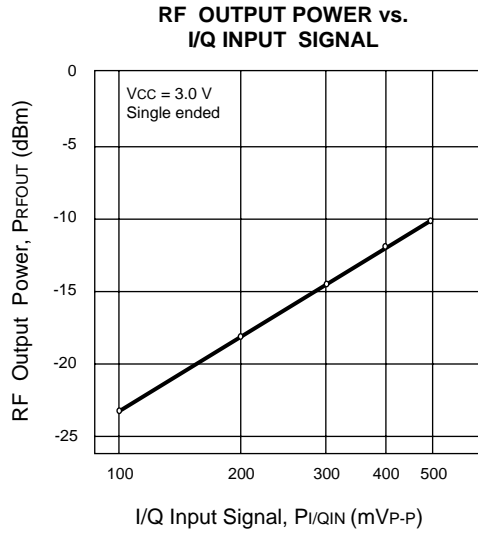

**TYPICAL SINE WAVE MODULATION OUTPUT SPECTRUM**

<PDC> 42 kbps, RNYQ α = 0.5, MOD PATTERN [0000]

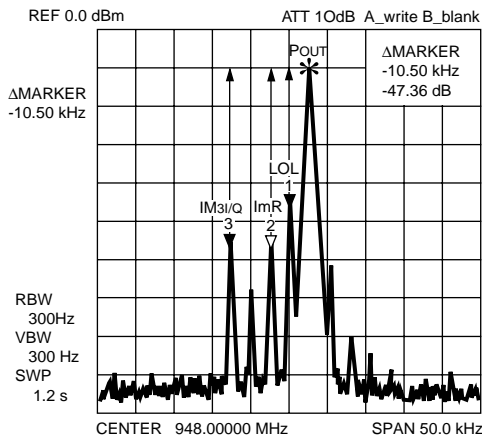

**TYPICAL π/4DQPSK MODULATION OUTPUT SPECTRUM**

<PDC> 42 kbps, RNYQ α = 0.5, MOD PATTERN [0000]

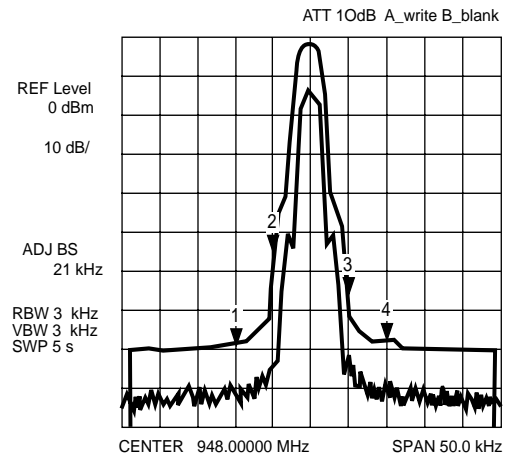

Padj (dB)	Marker	No. 1: 947.90 MHz	-78.0 dB	Δf = -100 kHz
		No. 2: 947.95 MHz	-67.0 dB	Δf = -50 kHz
		No. 1: 948.05 MHz	-70.3 dB	Δf = +50 kHz
		No. 2: 948.10 MHz	-77.8 dB	Δf = +100 kHz

**TYPICAL PERFORMANCE CURVES** Unless Otherwise Specified, ( $T_A = +25^\circ\text{C}$ ,  $V_{CC} = V_{PS} = 3\text{ V}$ , I/Q DC offset = 1.5 V, I/Q Input Signal = 500 mV<sub>p-p</sub> (Single ended),  $f_{I/Q} = 2.625\text{ kHz}$ ,  $f_{LOIN} = 948\text{ MHz}$ ,  $P_{LOIN} = -10\text{ dBm}$ , <PDC>Transmission Speed: 42 kbps, RNYQ: a = 0.5.)

**POWER SAVE RESPONSE**  
(at  $V_{CC} = V_{PS} = 2.7\text{ V}$ )

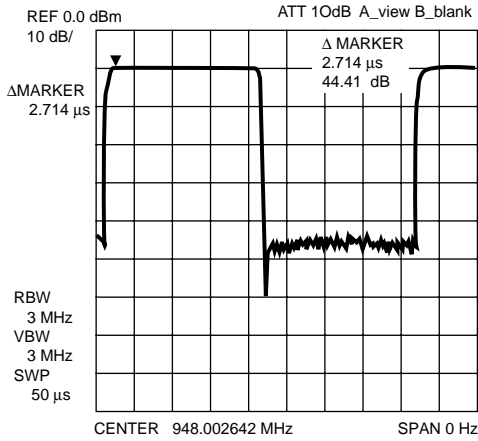

**POWER SAVE RESPONSE**  
(at  $V_{CC} = V_{PS} = 3.0\text{ V}$ )

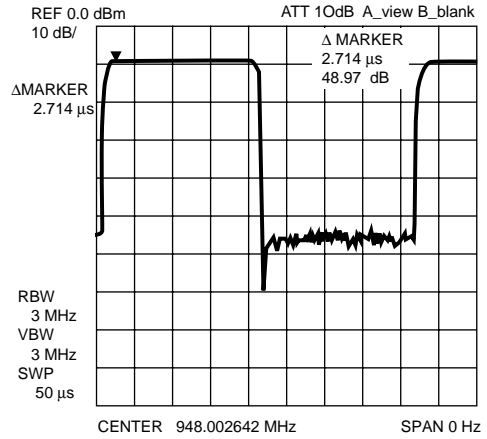

**POWER SAVE RESPONSE**  
(at  $V_{CC} = V_{PS} = 3.6\text{ V}$ )

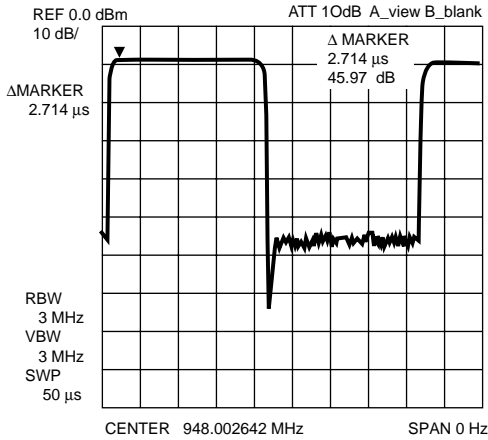

**SCATTERING PARAMETERS** ( $T_A = +25^\circ\text{C}$ )

**Lo INPUT IMPEDANCE (L<sub>oIN</sub>)**  
(at  $V_{CC} = V_{PS} = 3.0\text{ V}$ )

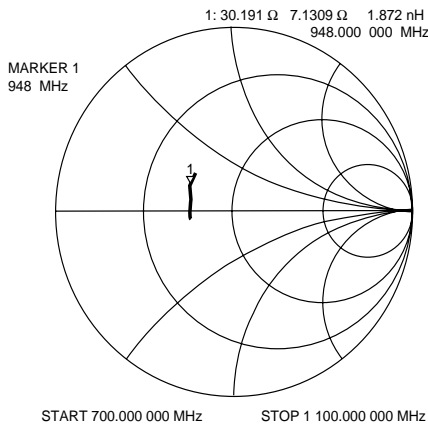

**RF OUTPUT IMPEDANCE (R<sub>Fout</sub>)**  
(at  $V_{CC} = V_{PS} = 3.0\text{ V}$ )

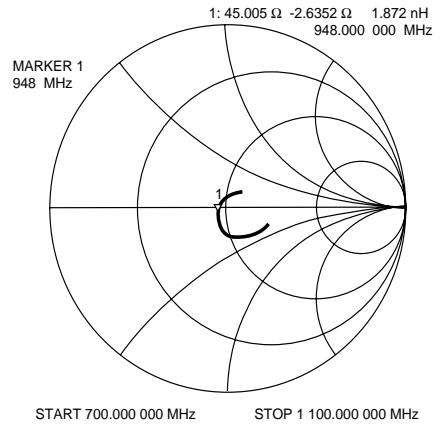

**EXPLANATION OF INTERNAL FUNCTIONS**

Block	Function/Operation	Block Diagram
90° PHASE SHIFTER	Input signal from the LO input is sent to a T-type flip-flop through a frequency doubler. The output signal from the T-type F/F is changed to the same frequency as the LO input with a quadrature phase shift of 0°, 90°, 180°, or 270°. These circuits provide self phase correction for proper quadrature signals.	
BUFFER AMPLIFIER	Buffer amplifiers for each phase signal are sent to each mixer.	
MIXER	The signals from the buffer amps are quadrature modulated with two double-balanced mixers. High accurate phase and amplitude inputs are realized to provide excellent image rejection.	
ADDER	Output signals from each mixer are added and sent through a final amplifier.	

**OUTLINE DIMENSIONS** (Units in mm)

**PACKAGE OUTLINE S20 (SSOP20)**

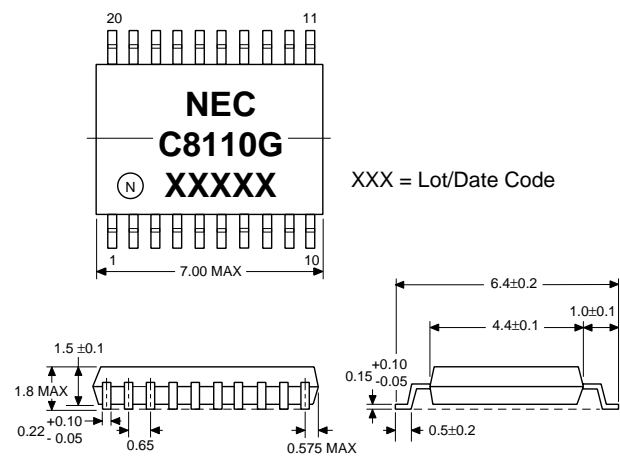

Note:  
All dimensions are typical unless otherwise specified.

**ORDERING INFORMATION**

PART NUMBER	QTY
UPC8110GR-E1	2.5 K/Reel

**INTERNAL BLOCK DIAGRAM**

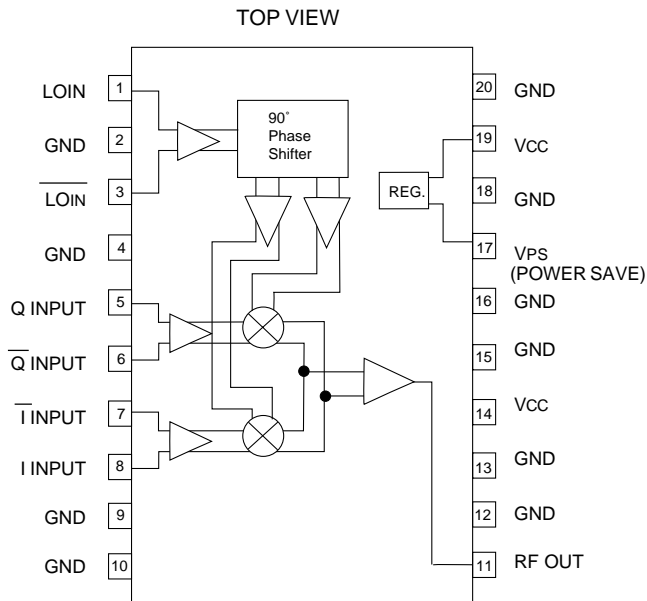

EXCLUSIVE NORTH AMERICAN AGENT FOR **NEC** RF, MICROWAVE & OPTOELECTRONIC SEMICONDUCTORS

**CEL** CALIFORNIA EASTERN LABORATORIES • Headquarters • 4590 Patrick Henry Drive • Santa Clara, CA 95054-1817 • (408) 988-3500 • Telex 34-6393 • FAX (408) 988-0279  
24-Hour Fax-On-Demand: 800-390-3232 (U.S. and Canada only) • Internet: <http://WWW.CEL.COM>

DATA SUBJECT TO CHANGE WITHOUT NOTICE

09/14/2000

# Mouser Electronics

Authorized Distributor

Click to View Pricing, Inventory, Delivery & Lifecycle Information:

[CEL:](#)

[UPC3227TB-E3-A](#)