

### Pin Descriptions

Pin Name	Pin #	Description
V <sub>CC</sub>	1	Positive Power Supply
GND	2	Ground
OUT	3	Output Stage

### Functional Block Diagram

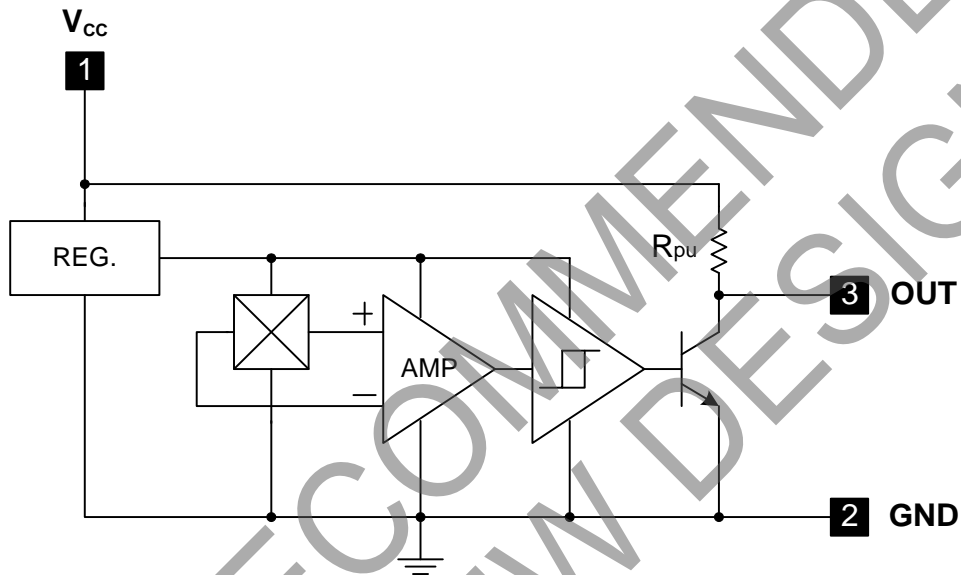

### Absolute Maximum Ratings (T<sub>A</sub> = +25°C)

Symbol	Characteristics	Values	Unit	
V <sub>CC</sub>	Supply Voltage	20	V	
V <sub>OUT (Off)</sub>	Output "Off" Voltage	20	V	
I <sub>O (Sink)</sub>	Output "On" Current	25	mA	
T <sub>S</sub>	Storage Temperature Range	-65 to +150	°C	
T <sub>J</sub>	Maximum Junction Temperature	+150	°C	
P <sub>D</sub>	Power Dissipation	SIP-3	550	mW
		SC59	230	mW

### Recommended Operating Conditions

Symbol	Characteristic	Conditions	Min	Max	Unit
V <sub>CC</sub>	Supply Voltage	Operating	3	20	V
T <sub>A</sub>	Operating Ambient Temperature	Operating	-40	+125	°C

### Electrical Characteristics (T<sub>A</sub> = +25°C)

Symbol	Characteristics	Conditions	Min	Typ	Max	Unit
V <sub>OUT (SAT)</sub>	Output Saturation Voltage	V <sub>CC</sub> = 12V, OUT "ON" I <sub>O</sub> = 10mA	-	300	400	mV
I <sub>CC</sub>	Supply Current	V <sub>CC</sub> = 12V, OUT "OFF"	-	3.5	6	mA
R <sub>pu</sub>	Internal Pull-up Resistor	-	7	10	13	KΩ
V <sub>d</sub>	Dropout Voltage	V <sub>d</sub> = V <sub>CC</sub> - V <sub>CE</sub>	-	-	0.3	V

### Magnetic Characteristics (T<sub>A</sub> = +25°C, V<sub>CC</sub> = 12V, unless otherwise specified, Note 4)

(1mT = 10 Gauss)

#### A Grade

Symbol	Parameter	Min	Typ	Max	Unit
B <sub>ops</sub> (South Pole to Brand Side)	Operation Point	15	-	60	Gauss
B <sub>rps</sub> (South Pole to Brand Side)	Release Point	-60	-	-15	Gauss
B <sub>hy</sub> ( B <sub>opx</sub>  - B <sub>rpx</sub>  )	Hysteresis	-	80	-	Gauss

#### B Grade

Symbol	Parameter	Min	Typ	Max	Unit
B <sub>ops</sub> (South Pole to Brand Side)	Operation Point	5	-	80	Gauss
B <sub>rps</sub> (South Pole to Brand Side)	Release Point	-80	-	-5	Gauss
B <sub>hy</sub> ( B <sub>opx</sub>  - B <sub>rpx</sub>  )	Hysteresis	-	80	-	Gauss

Notes: 4. Magnetic characteristics may vary with supply voltage, operating temperature and after soldering.

### Operating Characteristics

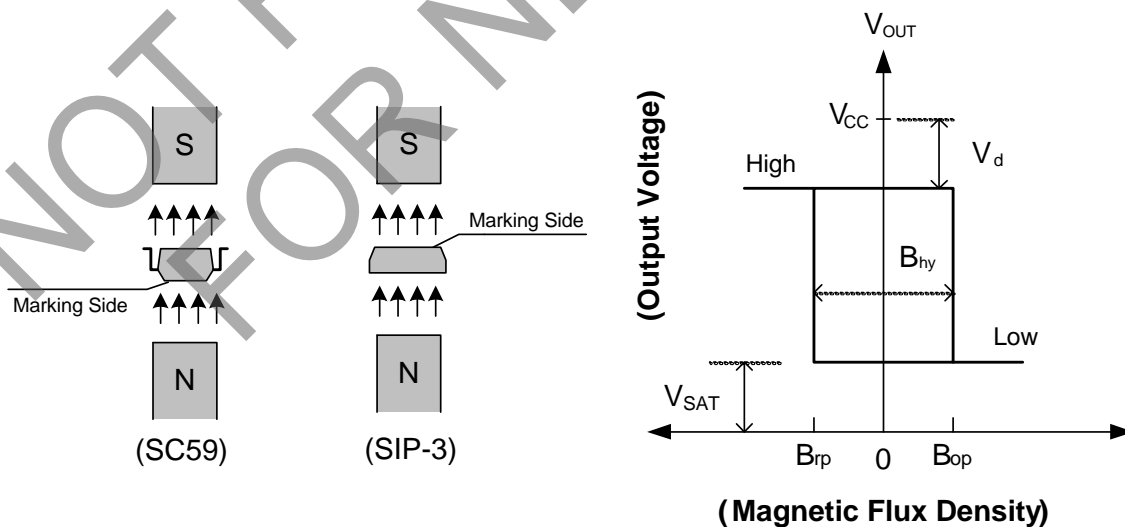

**Performance Characteristics**

(1) SIP-3

$T_A$ (°C)	25	50	60	70	80	85	90	95	100
$P_D$ (mW)	550	440	396	352	308	286	264	242	220
$T_A$ (°C)	105	110	115	120	125	130	135	140	150
$P_D$ (mW)	198	176	154	132	110	88	66	44	0

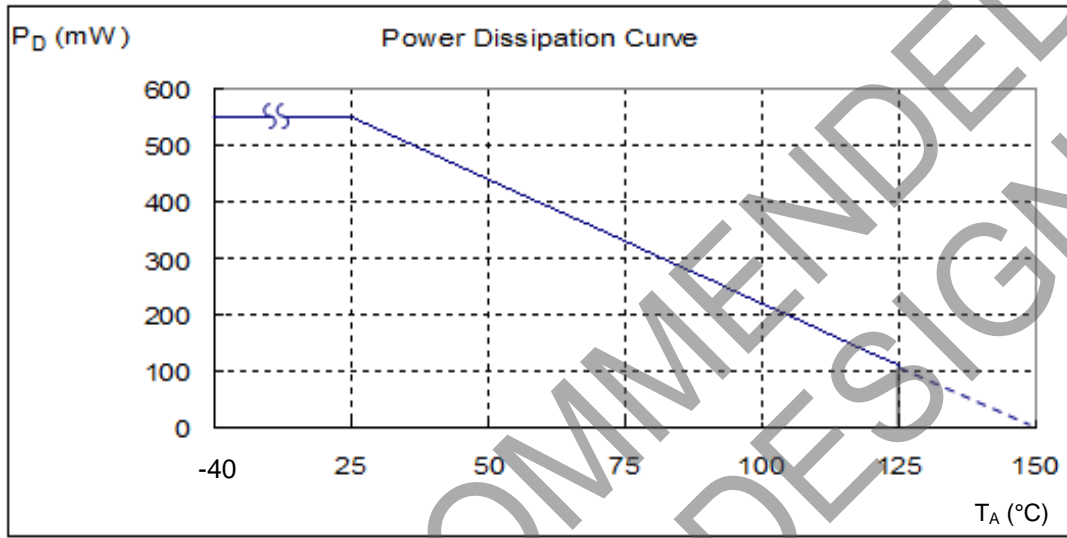

(2) SC59 (Commonly Known as SOT23 in Asia)

$T_A$ (°C)	25	50	60	70	80	85	90	100	110	120	130	140	150
$P_D$ (mW)	230	184	166	147	129	120	110	92	74	55	37	18	0

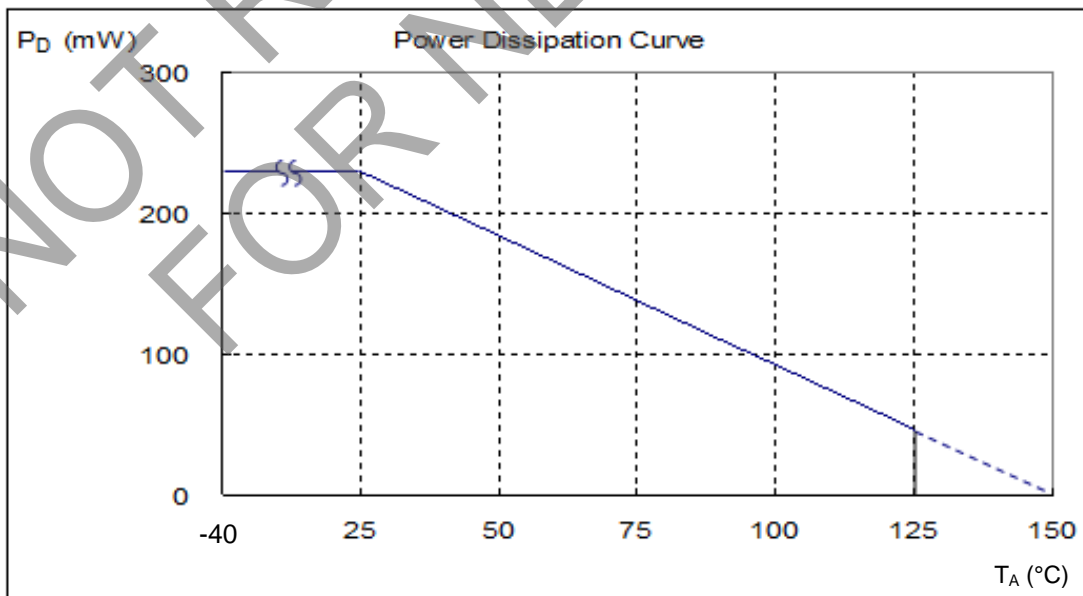

## Ordering Information

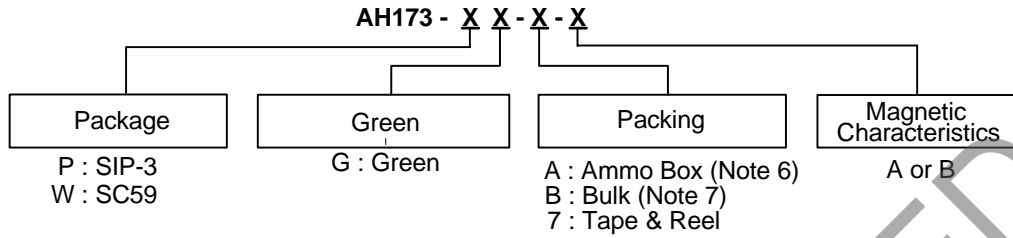

Part Number	Status (Note 8)	Package Code	Packaging (Note 5)	Bulk		7" Tape and Reel		Ammo Box	
				Quantity	Part Number Suffix	Quantity	Part Number Suffix	Quantity	Part Number Suffix
AH173-PG-A-A	NRND	P	SIP-3	NA	NA	NA	NA	4000/Box	-A
AH173-PG-A-B	NRND	P	SIP-3	NA	NA	NA	NA	4000/Box	-A
AH173-PG-B-A	NRND	P	SIP-3	1000	-B	NA	NA	NA	NA
AH173-PG-B-B	NRND	P	SIP-3	1000	-B	NA	NA	NA	NA
AH173-WG-7-A	NRND	W	SC59	NA	NA	3000/Tape & Reel	-7	NA	NA
AH173-WG-7-B	NRND	W	SC59	NA	NA	3000/Tape & Reel	-7	NA	NA

- Notes:
5. Pad layout as shown on Diodes Incorporated's suggested pad layout document, which can be found on our website at <http://www.diodes.com/package-outlines.html>.
  6. Ammo Box is for SIP-3 Spread Lead.
  7. Bulk is for SIP-3 Straight Lead.
  - 8: NRND = Not Recommended for New Design

NOT RECOMMENDED FOR NEW DESIGN

**Marking Information**

(1) Package Type: SIP-3 (Ammo Pack), SIP-3 (Bulk Pack)

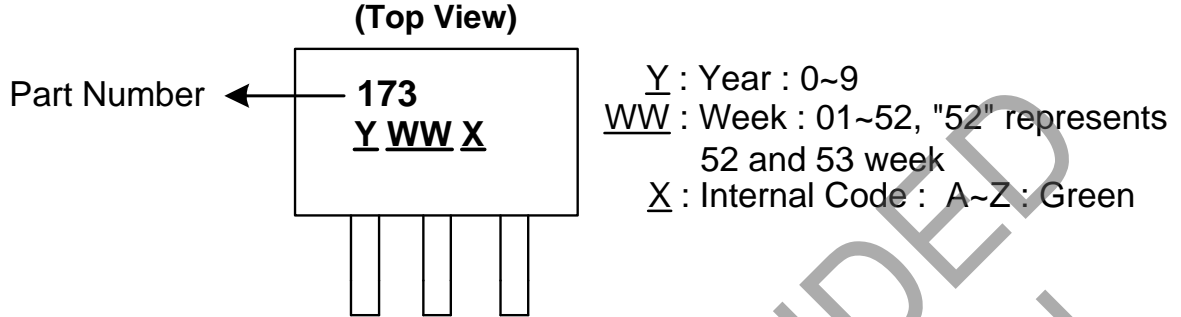

Part Number	Package	Identification Code
AH173	SIP-3 (Ammo Pack)	173
AH173	SIP-3 (Bulk Pack)	173

(2) Package Type: SC59 (Commonly Known as SOT23 in Asia)

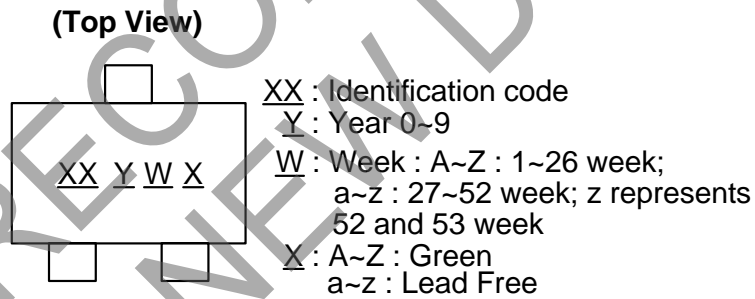

Part Number	Package	Identification Code
AH173	SC59	J3

**Package Outline Dimensions** (All Dimensions in mm)

Please see <http://www.diodes.com/package-outlines.html> for the latest version.

**(1) Package Type: SIP-3 (Bulk Pack)**

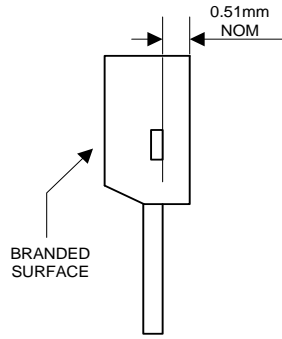

Active Area Depth

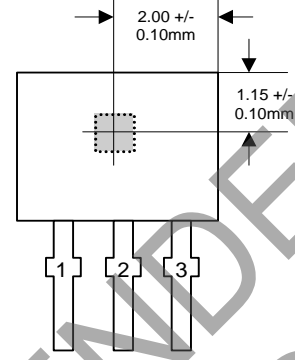

Sensor Location

**Package Dimension**

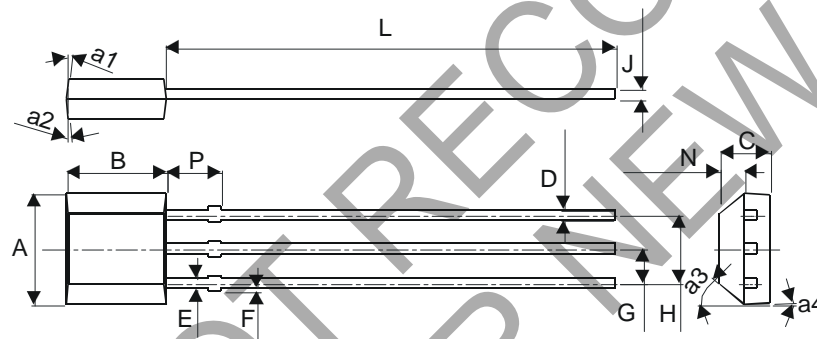

SIP-3 (Bulk Pack)		
Dim	Min	Max
A	3.9	4.3
a1	5° Typ	
a2	5° Typ	
a3	45° Typ	
a4	3° Typ	
B	2.8	3.2
C	1.40	1.60
D	0.33	0.432
E	0.40	0.508
F	0	0.2
G	1.24	1.30
H	2.51	2.57
J	0.35	0.43
L	14.0	15.0
N	0.63	0.84
P	1.55	-
All Dimensions in mm		

**Package Outline Dimensions** (Continued)

Please see <http://www.diodes.com/package-outlines.html> for the latest version.

**(2) Package Type: SIP-3 (Ammo Pack)**

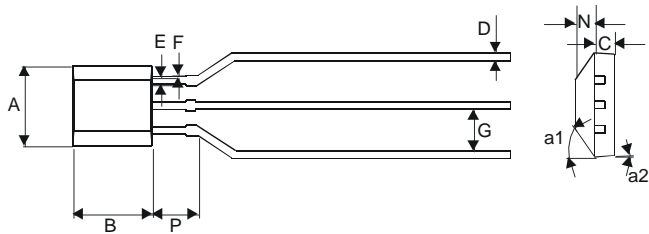

SIP-3 (Ammo Pack)		
Dim	Min	Max
A	3.9	4.3
a1	45° Typ	
a2	3° Typ	
B	2.8	3.2
C	1.40	1.60
D	0.35	0.41
E	0.43	0.48
F	0	0.2
G	2.4	2.9
N	0.63	0.84
P	1.55	-
All Dimensions in mm		

**(3) SC59 (Commonly Known as SOT23 in Asia)**

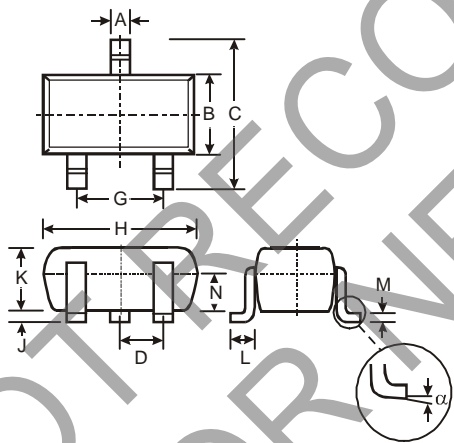

SC59			
Dim	Min	Max	Typ
A	0.35	0.50	0.38
B	1.50	1.70	1.60
C	2.70	3.00	2.80
D	-	-	0.95
G	-	-	1.90
H	2.90	3.10	3.00
J	0.013	0.10	0.05
K	1.00	1.30	1.10
L	0.35	0.55	0.40
M	0.10	0.20	0.15
N	0.70	0.80	0.75
α	0°	8°	-
All Dimensions in mm			

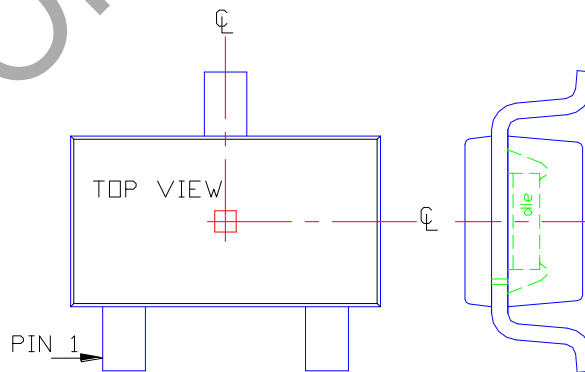

CL = Package Center Line

## Suggested Pad Layout

Please see <http://www.diodes.com/package-outlines.html> for the latest version.

### (1) Package Type: SC59 (Commonly Known as SOT23 in Asia)

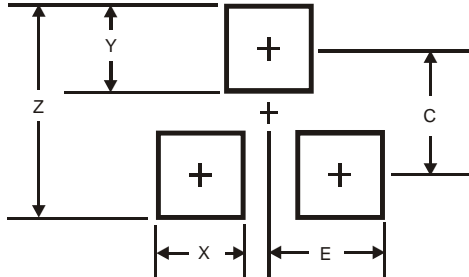

Dimensions	Value (in mm)
Z	3.4
X	0.8
Y	1.0
C	2.4
E	1.35

### IMPORTANT NOTICE

DIODES INCORPORATED MAKES NO WARRANTY OF ANY KIND, EXPRESS OR IMPLIED, WITH REGARDS TO THIS DOCUMENT, INCLUDING, BUT NOT LIMITED TO, THE IMPLIED WARRANTIES OF MERCHANTABILITY AND FITNESS FOR A PARTICULAR PURPOSE (AND THEIR EQUIVALENTS UNDER THE LAWS OF ANY JURISDICTION).

Diodes Incorporated and its subsidiaries reserve the right to make modifications, enhancements, improvements, corrections or other changes without further notice to this document and any product described herein. Diodes Incorporated does not assume any liability arising out of the application or use of this document or any product described herein; neither does Diodes Incorporated convey any license under its patent or trademark rights, nor the rights of others. Any Customer or user of this document or products described herein in such applications shall assume all risks of such use and will agree to hold Diodes Incorporated and all the companies whose products are represented on Diodes Incorporated website, harmless against all damages.

Diodes Incorporated does not warrant or accept any liability whatsoever in respect of any products purchased through unauthorized sales channel. Should Customers purchase or use Diodes Incorporated products for any unintended or unauthorized application, Customers shall indemnify and hold Diodes Incorporated and its representatives harmless against all claims, damages, expenses, and attorney fees arising out of, directly or indirectly, any claim of personal injury or death associated with such unintended or unauthorized application.

Products described herein may be covered by one or more United States, international or foreign patents pending. Product names and markings noted herein may also be covered by one or more United States, international or foreign trademarks.

This document is written in English but may be translated into multiple languages for reference. Only the English version of this document is the final and determinative format released by Diodes Incorporated.

### LIFE SUPPORT

Diodes Incorporated products are specifically not authorized for use as critical components in life support devices or systems without the express written approval of the Chief Executive Officer of Diodes Incorporated. As used herein:

A. Life support devices or systems are devices or systems which:

1. are intended to implant into the body, or
2. support or sustain life and whose failure to perform when properly used in accordance with instructions for use provided in the labeling can be reasonably expected to result in significant injury to the user.

B. A critical component is any component in a life support device or system whose failure to perform can be reasonably expected to cause the failure of the life support device or to affect its safety or effectiveness.

Customers represent that they have all necessary expertise in the safety and regulatory ramifications of their life support devices or systems, and acknowledge and agree that they are solely responsible for all legal, regulatory and safety-related requirements concerning their products and any use of Diodes Incorporated products in such safety-critical, life support devices or systems, notwithstanding any devices- or systems-related information or support that may be provided by Diodes Incorporated. Further, Customers must fully indemnify Diodes Incorporated and its representatives against any damages arising out of the use of Diodes Incorporated products in such safety-critical, life support devices or systems.

Copyright © 2017, Diodes Incorporated

[www.diodes.com](http://www.diodes.com)