

Edition 2007-12-05

**published by Infineon Technologies AG,
Am Campeon 1-12,
81726 München, Germany**

**© Infineon Technologies AG 2007.
All Rights Reserved.**

Attention please!

The information herein is given to describe certain components and shall not be considered as a guarantee of characteristics. Terms of delivery and rights to technical change reserved.

We hereby disclaim any and all warranties, including but not limited to warranties of non-infringement, regarding circuits, descriptions and charts stated herein.

Information

For further information on technology, delivery terms and conditions and prices please contact your nearest Infineon Technologies Office (www.infineon.com).

Warnings

Due to technical requirements components may contain dangerous substances. For information on the types in question please contact your nearest Infineon Technologies Office.

Infineon Technologies Components may only be used in life-support devices or systems with the express written approval of Infineon Technologies, if a failure of such components can reasonably be expected to cause the failure of that life-support device or system, or to affect the safety or effectiveness of that device or system. Life support devices or systems are intended to be implanted in the human body, or to support and/or maintain and sustain and/or protect human life. If they fail, it is reasonable to assume that the health of the user or other persons may be endangered.

Uni- and Bipolar Hall IC Switches for Magnetic Field Applications

TLE4905G; TLE4935G;
TLE4945-2G

Features

- Digital output signal
- For unipolar and alternating magnetic fields
- Large temperature range
- Temperature compensated magnetic performance
- Protection against reversed polarity
- Output protection against electrical disturbances

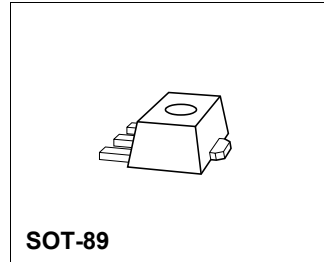

Type	Marking	Ordering Code	Package
TLE4905G	05	Q62705-K402	SOT-89
TLE4935G	35	Q62705-K404	SOT-89
TLE4945-2G	45 2	Q62705-K403	SOT-89

TLE4905/35/45-2 (Unipolar/Bipolar Magnetic Field Switches) have been designed specifically for automotive and industrial applications. Reverse polarity protection is included on-chip as is output protection against negative voltage transients.

Typical applications are position/proximity indicators, brushless DC motor commutation, rotational indexing etc.

Pin Configuration

(view on branded side of component)

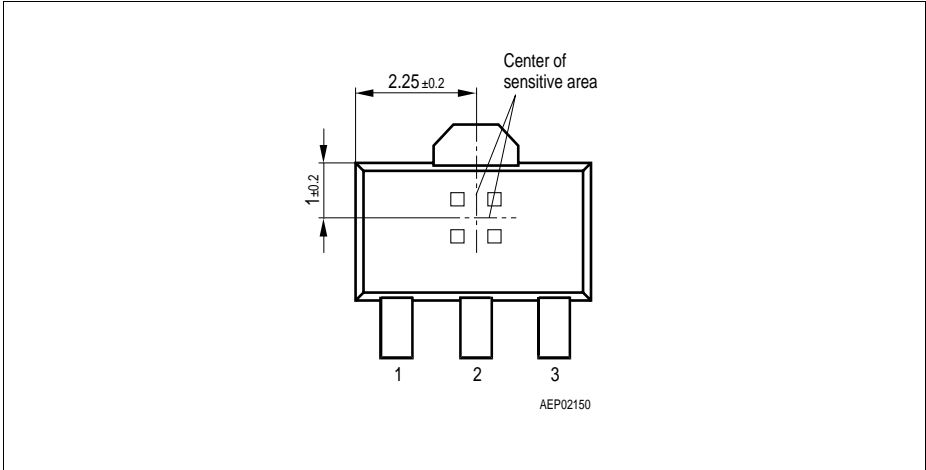

Figure 1

Pin Definitions and Functions

Pin No.	Symbol	Function
1	V_S	Supply voltage
2	GND	Ground
3	Q	Output

Circuit Description

The circuit includes Hall generator, amplifier and Schmitt-Trigger on one chip. The internal reference provides the supply voltage for the components. A magnetic field perpendicular to the chip surface induces a voltage at the hall probe. This voltage is amplified and switches a Schmitt-trigger with open-collector output. A protection diode against reverse power supply is integrated. The output is protected against electrical disturbances.

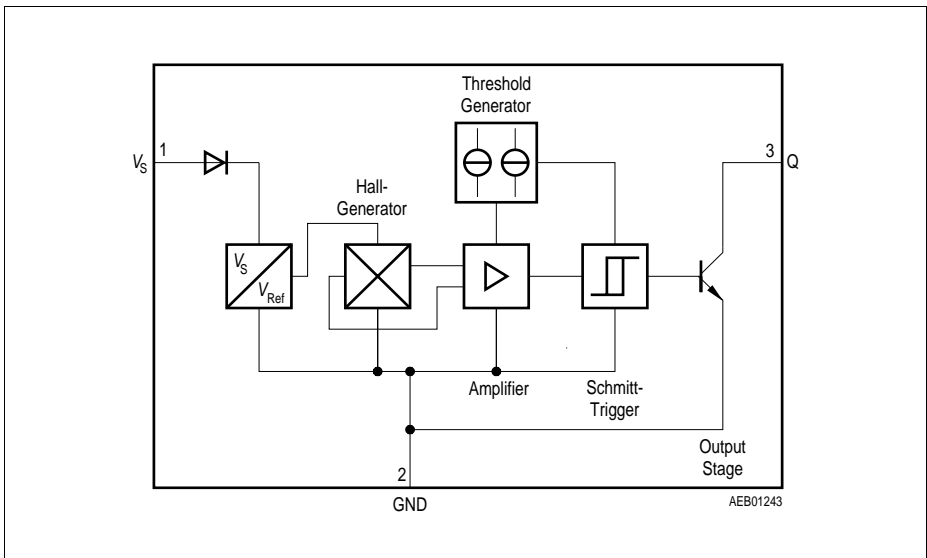

Figure 2 Block Diagram

Functional Description Unipolar Type TLE4905 (Figure 3 and 4)

When a positive magnetic field is applied in the indicated direction (**Figure 3**) and the turn-on magnetic induction B_{OP} is exceeded, the output of the Hall-effect IC will conduct (Operate Point). When the magnetic field is reduced to a value smaller than the release point, the output of the IC turns off (Release Point; **Figure 4**).

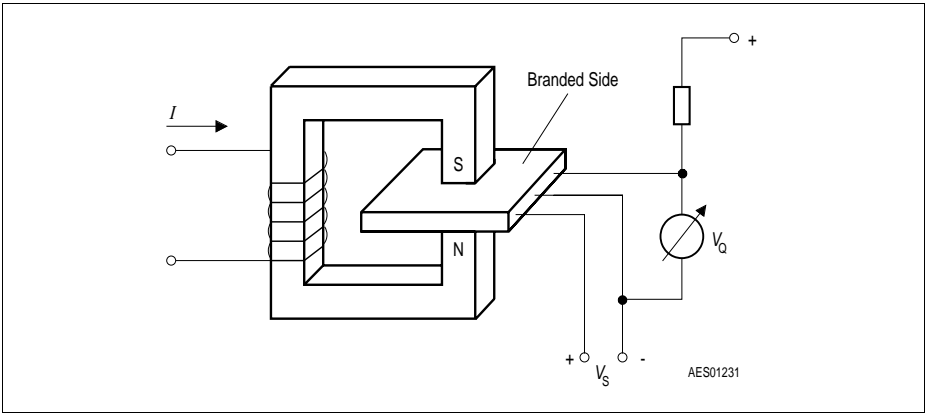

Figure 3 Sensor/Magnetic-Field Configuration

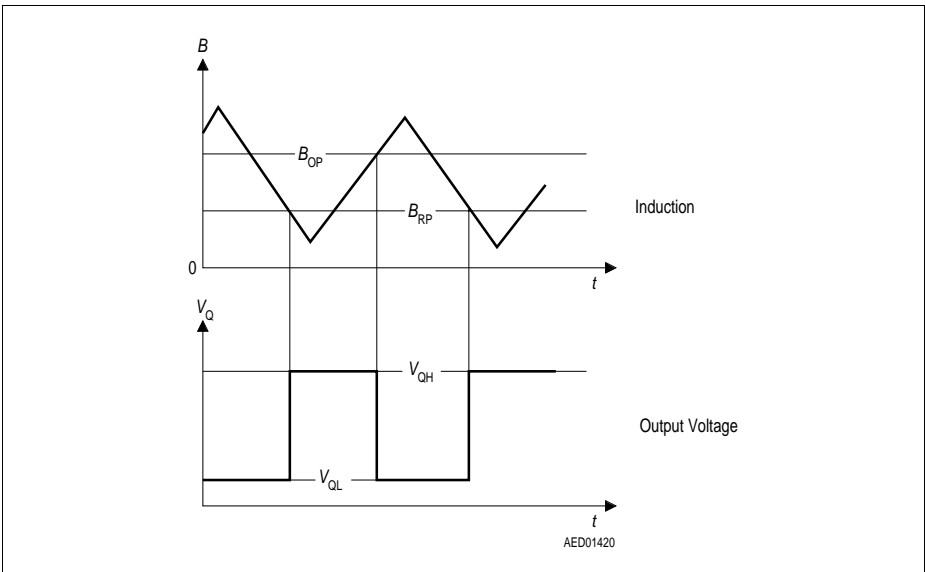

Figure 4 Switching Characteristics Unipolar Type

Functional Description Bipolar Type TLE4935/45-2 (Figure 5 and 6)

When a positive magnetic field is applied in the indicated direction (**Figure 5**) and the turn-on magnetic induction B_{OP} is exceeded, the output of the Hall-effect IC will conduct (Operate Point). The output state does not change unless a reverse magnetic field exceeding the turn-off magnetic induction $|B_{RP}|$ is exceeded. In this case the output will turn off (Release Point; **Figure 6**).

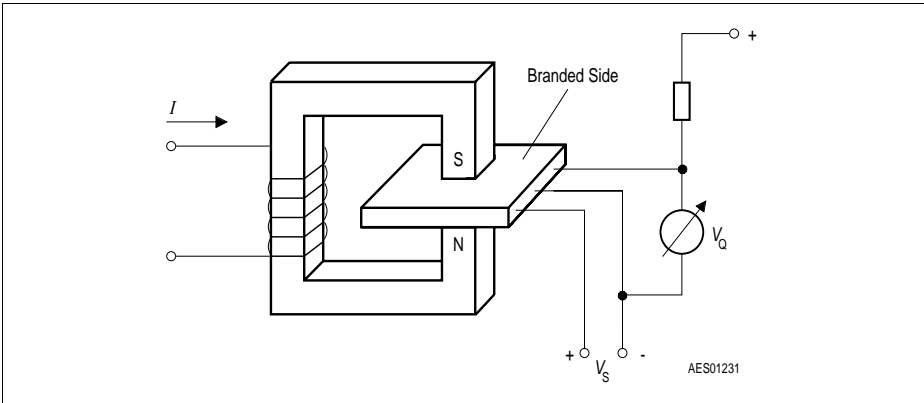

Figure 5 Sensor/Magnetic-Field Configuration

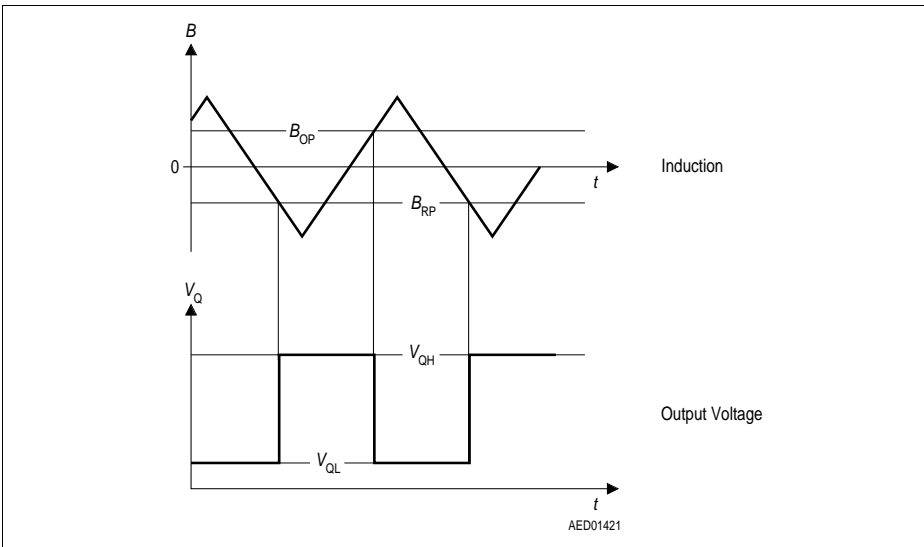

Figure 6 Switching Characteristics Bipolar Type

Absolute Maximum Ratings

$T_j = -40$ to 150 °C

Parameter	Symbol	Limit Values		Unit	Remarks
		min.	max.		
Supply voltage	V_S	- 40	32	V	-
Supply voltage	V_S	-	40	V	$t < 400$ ms; $v = 0.1$
Output voltage	V_Q	-	32	V	-
Output current	I_Q	-	100	mA	-
Output reverse current	$-I_Q$	-	100	mA	-
Junction temperature	T_j	- 40	150	°C	-
Storage temperature	T_{stg}	- 50	150	°C	-
Thermal resistance	$R_{th JA}$	-	100	K/W	-

Note: Stresses above those listed here may cause permanent damage to the device. Exposure to absolute maximum rating conditions for extended periods may affect device reliability.

Operating Range

Parameter	Symbol	Limit Values		Unit	Remarks
		min.	max.		
Supply voltage	V_S	4.0	24	V	-
Junction temperature	T_j	- 40	150	°C	-

Note: In the operating range the functions given in the circuit description are fulfilled.

AC/DC Characteristics

$4.0\text{ V} \leq V_S \leq 24\text{ V}$; $-40\text{ }^\circ\text{C} \leq T_j \leq 150\text{ }^\circ\text{C}$

Parameter	Symbol	Limit Values			Unit	Test Condition	Test Circuit
		min.	typ.	max.			
Supply current	I	1.6	–	5.0	mA		1
	I_{SHigh}	–	2.5	–	mA	$B < B_{\text{RP}}$	1
	I_{SLow}	–	3.5	–	mA	$B > B_{\text{OP}}$	1
Output saturation voltage	V_{QSat}	–	0.25	0.5	V	$I_{\text{Q}} = 40\text{ mA}$	1
Output leakage current	I_{QL}	–	–	10	μA	$V_{\text{Q}} = 18\text{ V}$	1
Rise/fall time	t_r / t_f	–	–	1	μs	$R_{\text{L}} = 1.2\text{ k}\Omega$ $C_{\text{L}} \leq 33\text{ pF}$	1

Note: The listed characteristics are ensured over the operating range of the integrated circuit. Typical characteristics specify mean values expected over the production spread. If not otherwise specified, typical characteristics apply at $T_j = 25\text{ }^\circ\text{C}$ and the given supply voltage.

Magnetic Characteristics
 $4.0\text{ V} \leq V_S \leq 24\text{ V}$

Parameter	Symbol	Limit Values						Unit
		TLE4905 unipolar		TLE4935 bipolar latch		TLE4945-2 bipolar switch		
		min.	max.	min.	max.	min.	max.	

Junction Temperature $T_j = -40\text{ }^\circ\text{C}$

Turn-ON induction	B_{OP}	7.5	19	10	20	-3	6	mT
Turn-OFF induction	B_{RP}	5.5	17	-20	-10	-6	3	mT
Hysteresis ($B_{OP}-B_{RP}$)	ΔB_H	2	6.5	20	40	1	5	mT

Junction Temperature $T_j = 25\text{ }^\circ\text{C}$

Turn-ON induction	B_{OP}	7	18	10	20	-3	6	mT
Turn-OFF induction	B_{RP}	5	16	-20	-10	-6	3	mT
Hysteresis ($B_{OP}-B_{RP}$)	ΔB_H	2	6	20	40	1	5	mT

Junction Temperature $T_j = 85\text{ }^\circ\text{C}$

Turn-ON induction	B_{OP}	6.5	17.5	10	20	-3	6	mT
Turn-OFF induction	B_{RP}	4.5	15	-20	-10	-6	3	mT
Hysteresis ($B_{OP}-B_{RP}$)	ΔB_H	2	5.5	20	40	1	5	mT

Junction Temperature $T_j = 150\text{ }^\circ\text{C}$

Turn-ON induction	B_{OP}	6	17	10	20	-3	6	mT
Turn-OFF induction	B_{RP}	4	14	-20	-10	-6	3	mT
Hysteresis ($B_{OP}-B_{RP}$)	ΔB_H	2	5	20	40	1	5	mT

Note: The listed characteristics are ensured over the operating range of the integrated circuit. Typical characteristics specify mean values expected over the production spread. If not otherwise specified, typical characteristics apply at $T_j = 25\text{ }^\circ\text{C}$ and the given supply voltage.

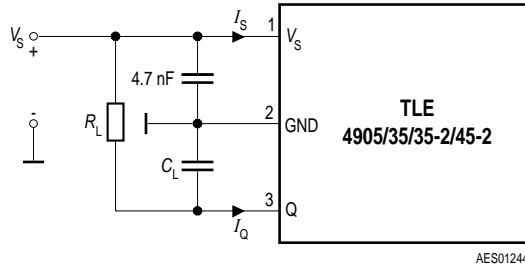

Unipolar Type TLE4905

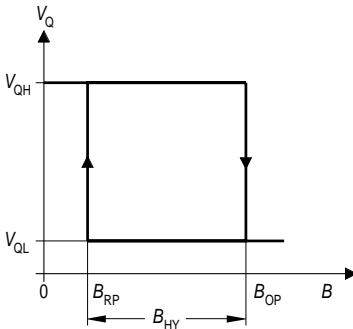

Bipolar Type TLE4935

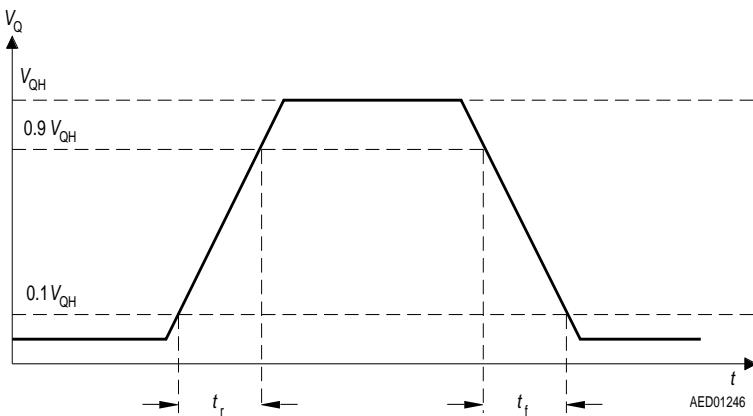
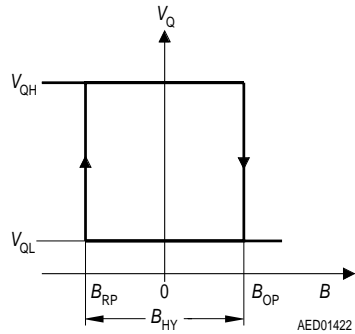

Figure 7 Test Circuit 1

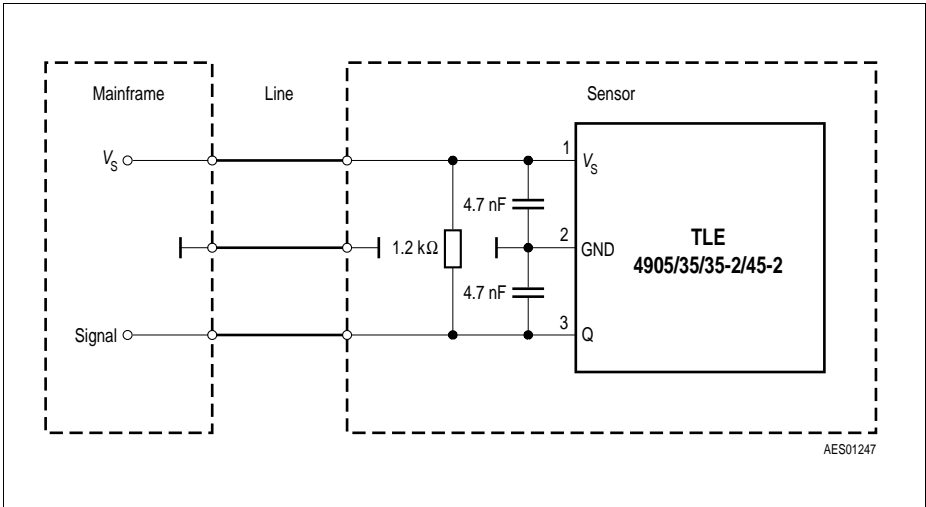
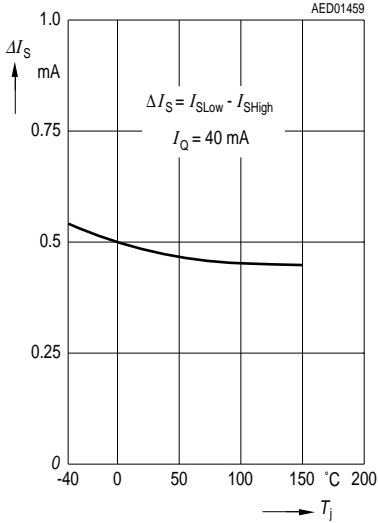

Figure 8 Application Circuit

If not otherwise specified, all curves reflect typical values at $T_j = 25\text{ }^\circ\text{C}$ and $V_S = 12\text{ V}$

Quiescent Current Difference versus Temperature



Saturation Voltage versus Output Current

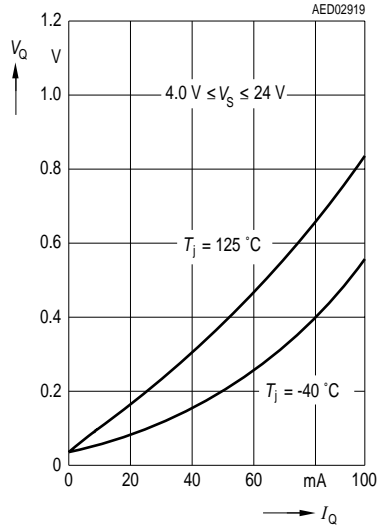

Quiescent Current versus Junction Temperature

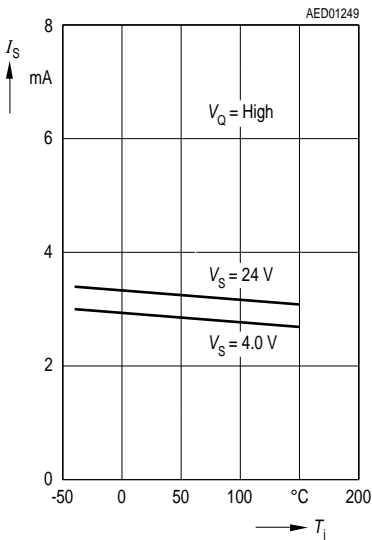

TLE4905 Operate-and Release-Point versus Junction Temperature

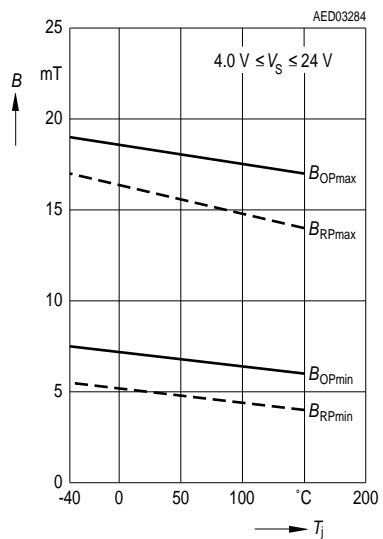

TLE4935 Operate-and Release-Point versus Junction Temperature

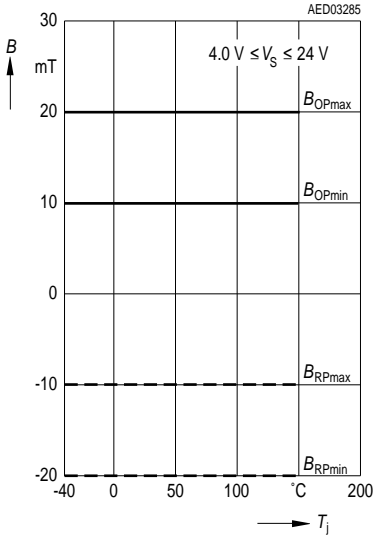

TTLE4945-2 Operate-and Release-Point versus Junction Temperature

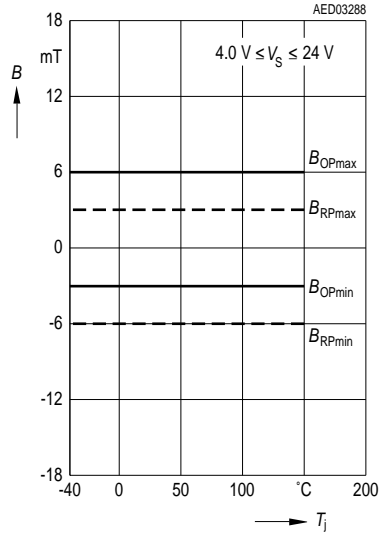

TLE4905 Hysteresis versus Junction Temperature

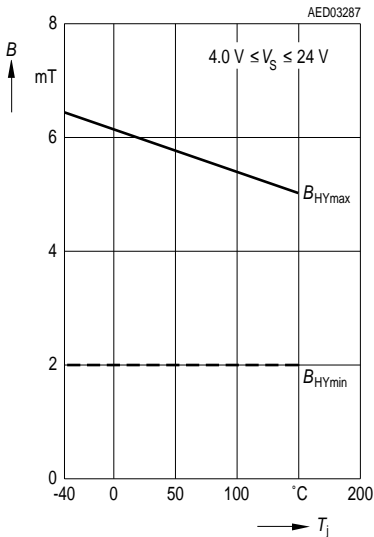

Package Outlines

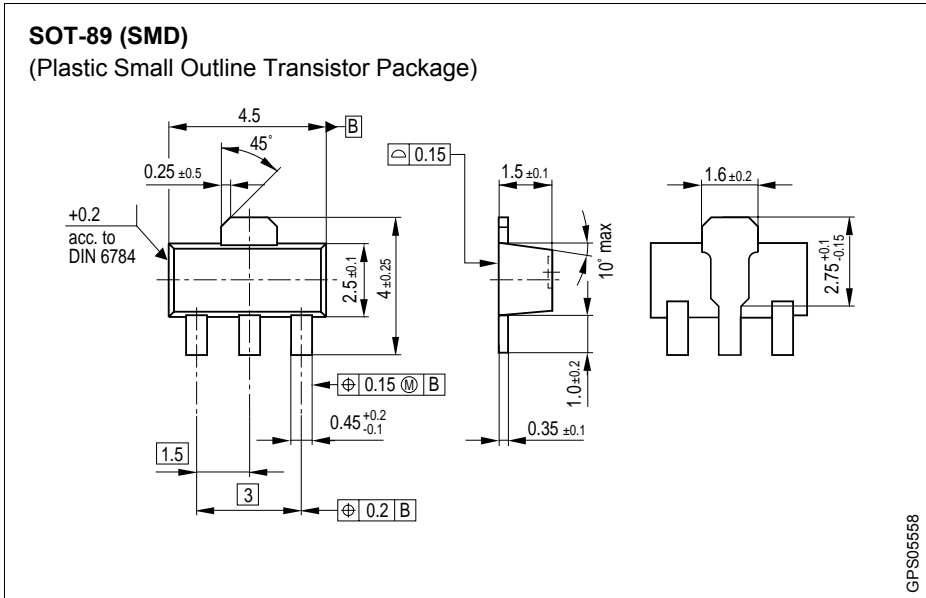

Package Information

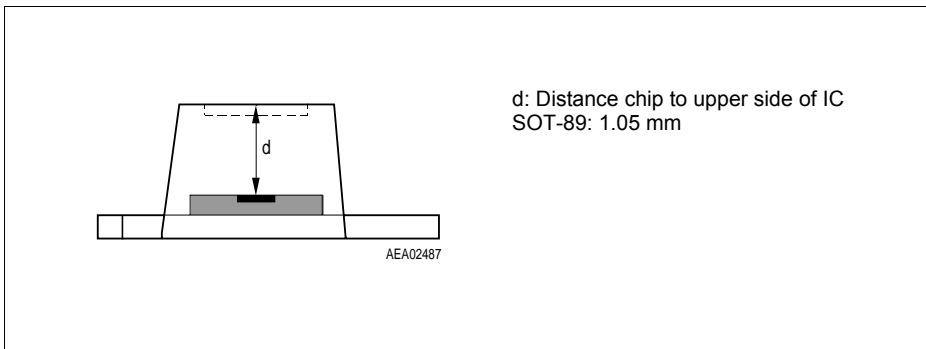

Sorts of Packing

Package outlines for tubes, trays etc. are contained in our data book "Package Information".

SMD = Surface Mounted Device

Dimensions in mm

Revision History:2007-12-05, V1.3

Previous Version: 2004-03-19, V1.2

Page	Subjects (major changes since last revision)
all	TLE4935-2G removed

For questions on technology, delivery and prices please contact the Infineon Technologies offices in Germany or the Infineon Technologies Companies and Representatives worldwide: see our webpage at <http://www.infineon.com>

We Listen to Your Comments

Any information within this document that you feel is wrong, unclear or missing at all? Your feedback will help us to continuously improve the quality of this document. Please send your proposal (including a reference to this document) to:

sensors@infineon.com



www.infineon.com

Published by Infineon Technologies AG

Mouser Electronics

Authorized Distributor

Click to View Pricing, Inventory, Delivery & Lifecycle Information:

[Infineon:](#)

[TLE4935G](#)