

**Absolute Maximum Ratings**

Operating Current (OUT to GND) .....	20mA	Operating Temperature Range.....	-40°C to +85°C
Forward Current (GND to OUT).....	20mA	Storage Temperature Range.....	-65°C to +150°C
Continuous Power Dissipation (T <sub>A</sub> = +70°C)		Lead Temperature (soldering, 10s) .....	+300°C
3-Pin SOT23 (derate 3.65mW/°C above +70°C) ...	291.73mW	Soldering Temperature (reflow).....	+260°C
8-Pin SO (derate 7.4mW/°C above +70°C).....	588.2mW		

Stresses beyond those listed under "Absolute Maximum Ratings" may cause permanent damage to the device. These are stress ratings only, and functional operation of the device at these or any other conditions beyond those indicated in the operational sections of the specifications is not implied. Exposure to absolute maximum rating conditions for extended periods may affect device reliability.

**Package Information**

**3 SOT23**

PACKAGE CODE	U3+1
Outline Number	<a href="#">21-0051</a>
Land Pattern Number	<a href="#">90-0179</a>
<b>Thermal Resistance, Multilayer Board:</b>	
Junction to Ambient (θ <sub>JA</sub> )	274.23°C/W
Junction to Case (θ <sub>JC</sub> )	86.19°C/W

**8 SO**

PACKAGE CODE	S8+2
Outline Number	<a href="#">21-0041</a>
Land Pattern Number	<a href="#">90-0096</a>
<b>Thermal Resistance, Multilayer Board:</b>	
Junction to Ambient (θ <sub>JA</sub> )	136°C/W
Junction to Case (θ <sub>JC</sub> )	38°/W

For the latest package outline information and land patterns (footprints), go to [www.maximintegrated.com/packages](http://www.maximintegrated.com/packages). Note that a "+", "#", or "-" in the package code indicates RoHS status only. Package drawings may show a different suffix character, but the drawing pertains to the package regardless of RoHS status.

Package thermal resistances were obtained using the method described in JEDEC specification JESD51-7, using a four-layer board. For detailed information on package thermal considerations, refer to [www.maximintegrated.com/thermal-tutorial](http://www.maximintegrated.com/thermal-tutorial).

**Electrical Characteristics—MAX6006**

(T<sub>A</sub> = -40°C to +85°C, unless otherwise noted. Typical values are at T<sub>A</sub> = +25°C.) (Note 1)

PARAMETER	SYMBOL	CONDITIONS	MIN	TYP	MAX	UNITS	
Reverse Breakdown Voltage	V <sub>R</sub>	T <sub>A</sub> = +25°C, I <sub>R</sub> = 1.2µA	MAX6006A (0.2%)	1.2475	1.2500	1.2525	V
			MAX6006B (0.5%)	1.2438	1.2500	1.2563	
Minimum Operating Current	I <sub>RMIN</sub>	V <sub>R</sub> change < 0.2% from V <sub>R</sub> at I <sub>R</sub> = 1.2µA		0.5	1.0	µA	
Reverse Breakdown Change with Current		I <sub>R</sub> = 1.2µA to 200µA			1.0	mV	
		I <sub>R</sub> = 200µA to 2mA			2.0		
Reverse Dynamic Impedance		I <sub>R</sub> = 1.2µA to 2mA (Note 2)			1.5	Ω	
Low-Frequency Noise		I <sub>R</sub> = 1.2µA, f = 0.1Hz to 10Hz		30		µV <sub>P-P</sub>	
Temperature Coefficient (Note 3)	TC	I <sub>R</sub> = 1.2µA	MAX6006A		30	ppm/°C	
			MAX6006B		75		
Long-Term Drift		1000h at T <sub>A</sub> = +25°C		150		ppm	
Thermal Hysteresis (Note 4)				200		ppm	

**Electrical Characteristics—MAX6007**(T<sub>A</sub> = -40°C to +85°C, unless otherwise noted. Typical values are at T<sub>A</sub> = +25°C.) (Note 1)

PARAMETER	SYMBOL	CONDITIONS	MIN	TYP	MAX	UNITS	
Reverse Breakdown Voltage	V <sub>R</sub>	T <sub>A</sub> = +25°C, I <sub>R</sub> = 1.2µA	MAX6007A (0.2%)	2.0439	2.048	2.0521	V
			MAX6007B (0.5%)	2.0378	2.048	2.0582	
Minimum Operating Current	I <sub>RMIN</sub>	V <sub>R</sub> change < 0.2% from V <sub>R</sub> at I <sub>R</sub> = 1.2µA		0.5	1.0	µA	
Reverse Breakdown Change with Current		I <sub>R</sub> = 1.2µA to 200µA			1.3	mV	
		I <sub>R</sub> = 200µA to 2mA			2.3		
Reverse Dynamic Impedance		I <sub>R</sub> = 1.2µA to 2mA (Note 2)			1.8	Ω	
Low-Frequency Noise		I <sub>R</sub> = 1.2µA, f = 0.1Hz to 10Hz		50		µV <sub>P-P</sub>	
Temperature Coefficient (Note 3)	TC	I <sub>R</sub> = 1.2µA	MAX6007A		30	ppm/°C	
			MAX6007B		75		
Long-Term Drift		1000h at T <sub>A</sub> = +25°C		150		ppm	
Thermal Hysteresis (Note 4)				200		ppm	

**Electrical Characteristics—MAX6008**(T<sub>A</sub> = -40°C to +85°C, unless otherwise noted. Typical values are at T<sub>A</sub> = +25°C.) (Note 1)

PARAMETER	SYMBOL	CONDITIONS	MIN	TYP	MAX	UNITS	
Reverse Breakdown Voltage	V <sub>R</sub>	T <sub>A</sub> = +25°C, I <sub>R</sub> = 1.2µA	MAX6008A (0.2%)	2.4950	2.5000	2.5050	V
			MAX6008B (0.5%)	2.4875	2.5000	2.5125	
Minimum Operating Current	I <sub>RMIN</sub>	V <sub>R</sub> change < 0.2% from V <sub>R</sub> at I <sub>R</sub> = 1.2µA		0.5	1.0	µA	
Reverse Breakdown Change with Current		I <sub>R</sub> = 1.2µA to 200µA			1.5	mV	
		I <sub>R</sub> = 200µA to 2mA			2.5		
Reverse Dynamic Impedance		I <sub>R</sub> = 1.2µA to 2mA (Note 2)			2	Ω	
Low-Frequency Noise		I <sub>R</sub> = 1.2µA, f = 0.1Hz to 10Hz		60		µV <sub>P-P</sub>	
Temperature Coefficient (Note 3)	TC	I <sub>R</sub> = 1.2µA	MAX6008A		30	ppm/°C	
			MAX6008B		75		
Long-Term Drift		1000h at T <sub>A</sub> = +25°C		150		ppm	
Thermal Hysteresis (Note 4)				200		ppm	

**Electrical Characteristics—MAX6009**

(T<sub>A</sub> = -40°C to +85°C, unless otherwise noted. Typical values are at T<sub>A</sub> = +25°C.) (Note 1)

PARAMETER	SYMBOL	CONDITIONS		MIN	TYP	MAX	UNITS
Reverse Breakdown Voltage	V <sub>R</sub>	T <sub>A</sub> = +25°C, I <sub>R</sub> = 1.2μA	MAX6009A (0.2%)	2.9940	3.000	3.0060	V
			MAX6009B (0.5%)	2.9850	3.000	3.0150	
Minimum Operating Current	I <sub>RMIN</sub>	V <sub>R</sub> change < 0.2% from V <sub>R</sub> at I <sub>R</sub> = 1.2μA			0.5	1.0	μA
Reverse Breakdown Change with Current		I <sub>R</sub> = 1.2μA to 200μA				1.7	mV
		I <sub>R</sub> = 200μA to 2mA				2.7	
Reverse Dynamic Impedance		I <sub>R</sub> = 1.2μA to 2mA (Note 2)				2.2	Ω
Low-Frequency Noise		I <sub>R</sub> = 1.2μA, f = 0.1Hz to 10Hz			75		μV <sub>P-P</sub>
Temperature Coefficient (Note 3)	TC	I <sub>R</sub> = 1.2μA	MAX6009A			30	ppm/°C
			MAX6009B			75	
Long-Term Drift		1000h at T <sub>A</sub> = +25°C			150		ppm
Thermal Hysteresis (Note 4)					200		ppm

- Note 1:** All devices are 100% production tested at T<sub>A</sub> = +25°C and are guaranteed by design for T<sub>A</sub> = T<sub>MIN</sub> to T<sub>MAX</sub>, as specified.
- Note 2:** This parameter is guaranteed by the “reverse breakdown change with current” test.
- Note 3:** TC is measured by the “box” method; i.e., (V<sub>MAX</sub> - V<sub>MIN</sub>)/(T<sub>MAX</sub> - T<sub>MIN</sub>).
- Note 4:** Thermal hysteresis is defined as the change in the +25°C output voltage after cycling the device from T<sub>MIN</sub> to T<sub>MAX</sub>.

**Typical Operating Characteristics**

(C<sub>L</sub> = 0.01μF, T<sub>A</sub> = +25°C, unless otherwise noted.)

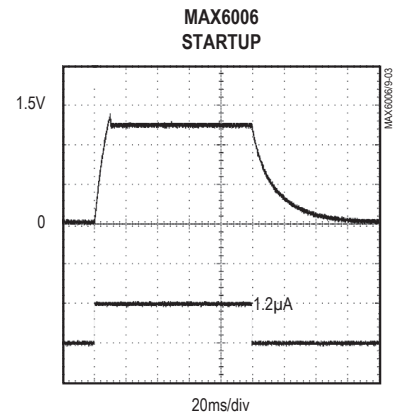
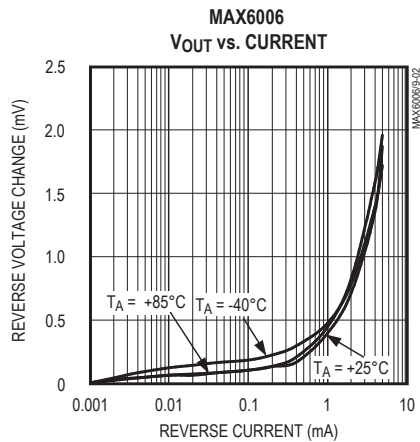
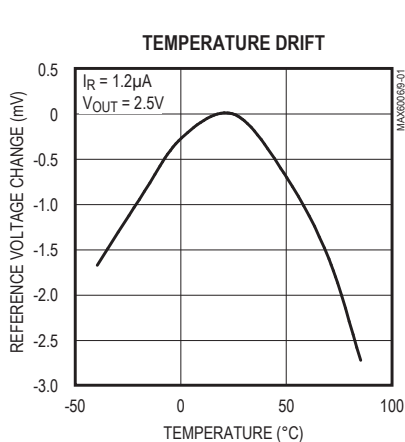

Typical Operating Characteristics (continued)

( $C_L = 0.01\mu\text{F}$ ,  $T_A = +25^\circ\text{C}$ , unless otherwise noted.)

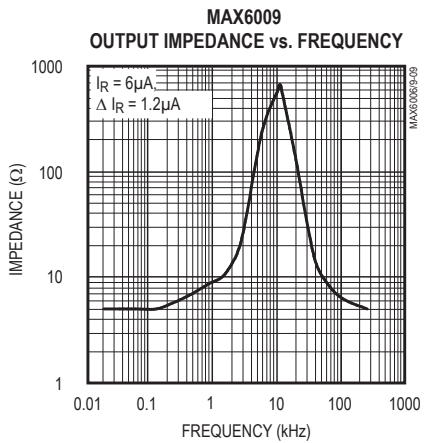
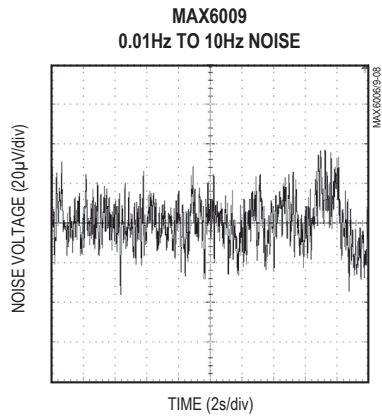
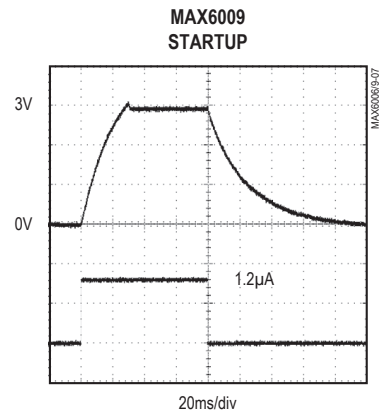
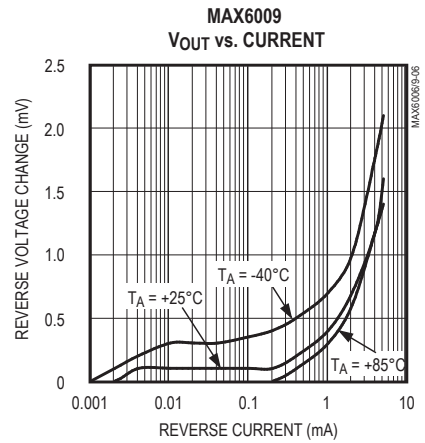
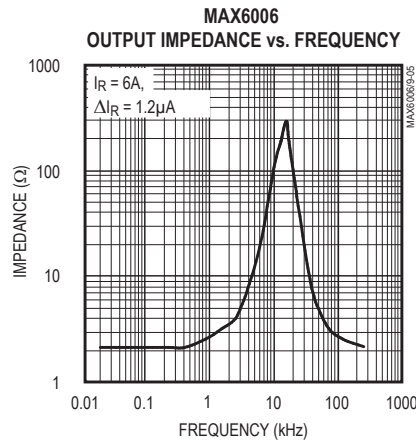
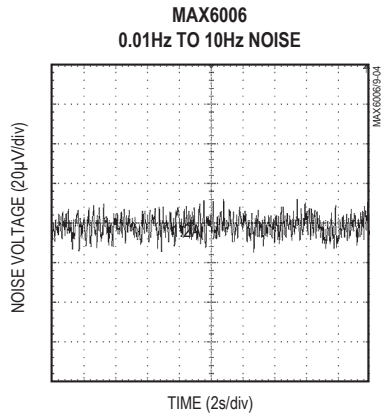

Pin Description

PIN		NAME	FUNCTION
SOT23	SO		
1	6, 8	OUT	Output Voltage. Bias OUT with a pullup resistor to a potential greater than OUT. Bypass OUT to GND with a 0.01µF or larger capacitor.
2	4	GND	Ground
3	—	IC	Internally connected test point. Leave this pin unconnected, or connect to GND.
—	1, 2, 3, 5, 7	N.C.	No connection. Not internally connected.

Detailed Description

The MAX6006–MAX6009 are precision, two-terminal, series bandgap voltage references. On-chip thin-film resistors are laser trimmed to provide 0.2% output voltage accuracies. Voltages of +1.25V, +2.048V, +2.5V, and +3.0V are available in the space-saving SOT23 package (2.1mm x 2.7mm).

Applications Information

Output/Load Capacitance

For devices in this family, OUT needs to be bypassed to GND with a 0.01µF or larger capacitor. In applications where the load or the supply can experience step changes, additional capacitance will reduce the amount of overshoot (or undershoot) and assist the circuit’s transient response.

Output Voltage Hysteresis

Output voltage hysteresis is the change in the output voltage at  $T_A = +25^\circ\text{C}$  before and after the device is cycled over its entire operating temperature range. Hysteresis is caused by differential package stress appearing across the bandgap core transistors. The temperature hysteresis value is typically less than 200ppm.

Turn-On Time

The output capacitance and bias current of the MAX6006–MAX6009 greatly affects turn-on settling time. In the *Typical Operating Characteristics*, turn-on time is shown with a 10nF output capacitor and a 1.2µA bias current. Under these conditions, the MAX6006–MAX6009 settle in 40ms. Settling time will linearly decrease in proportion to the circuit’s bias current.

Typical Applications

In the typical shunt regulator application shown in Figure 1,  $R_{BIAS}$  is used to set the current through the load ( $I_L$ ) and the current through the shunt regulator ( $I_{RMIN}$ ). There are two worst-case situations that  $R_{BIAS}$  needs to be sized for:

- 1)  $R_{BIAS}$  must be small enough that when  $V_S$  (supply voltage) is at its minimum and  $I_L$  is at its maximum,  $I_{RMIN}$  is equal to at least the minimum operating current of the shunt regulator.
- 2)  $R_{BIAS}$  must be large enough that when  $V_S$  is at its maximum and  $I_L$  is at its minimum,  $I_{RMIN}$  is  $< 2\text{mA}$ .

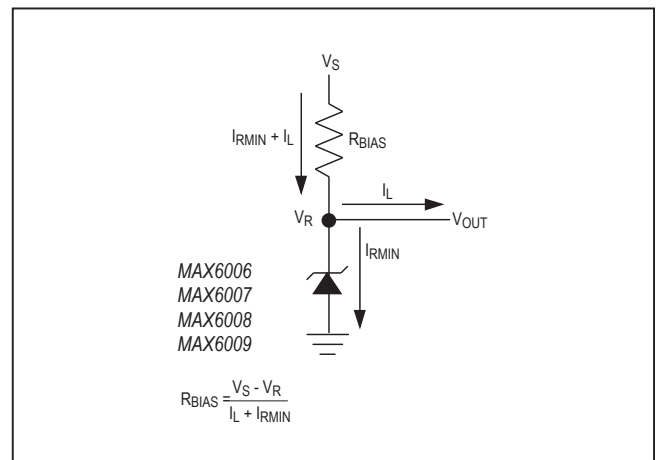

Figure 1. Typical Application Circuit

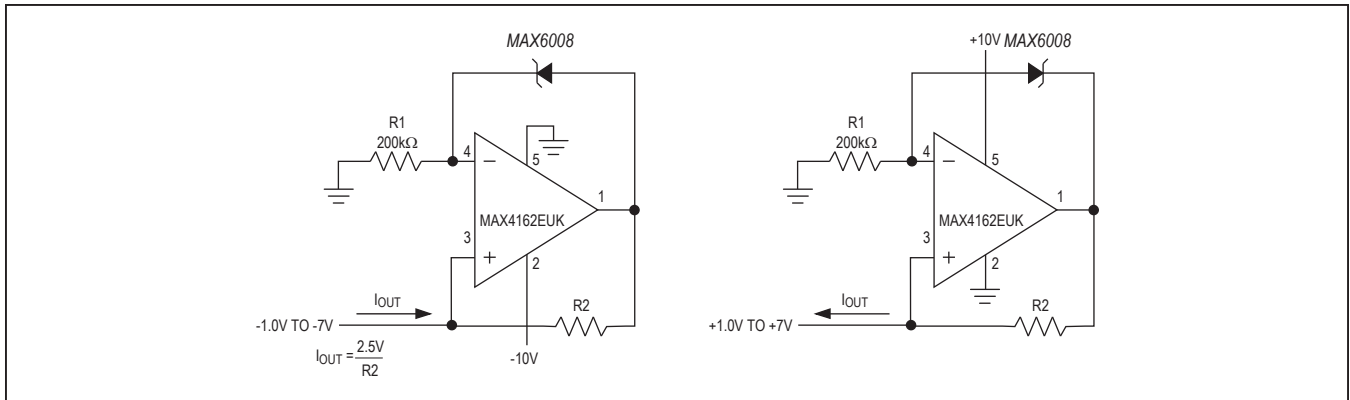

Figure 2. Precision 1µA to 1mA Current Sources

### Ordering Information (continued)

PART	OUTPUT VOLTAGE (V)	INITIAL ACCURACY (%)	TEMP COEFFICIENT (ppm/°C)	PIN-PACKAGE	TOP MARK
MAX6007BEUR+T	2.048	0.5	75	3 SOT23	+FZGL
MAX6007BESA+	2.048	0.5	75	8 SO	—
<b>MAX6008</b> AEUR+T	2.50	0.2	30	3 SOT23	+FZGN
MAX6008AEUR/V+T	2.50	0.2	30	3 SOT23	+FZWO
MAX6008AESA+	2.50	0.2	30	8 SO	—
MAX6008BEUR+T	2.50	0.5	75	3 SOT23	+FZGO
MAX6008BESA+	2.50	0.5	75	8 SO	—
<b>MAX6009</b> AEUR+T	3.00	0.2	30	3 SOT23	+FZGQ
MAX6009AESA+	3.00	0.2	30	8 SO	—
MAX6009BEUR+T	3.00	0.5	75	3 SOT23	+FZGR
MAX6009BESA+	3.00	0.5	75	8 SO	—

+Denotes a lead(Pb)-free/RoHS-compliant package.

/V denotes an automotive qualified part.

T = Tape and reel.

### Chip Information

PROCESS: BiCMOS

## Revision History

REVISION NUMBER	REVISION DATE	DESCRIPTION	PAGES CHANGED
0	8/00	Initial release	—
1	7/12	Added <i>N</i> to MAX6008 and updated <i>Ordering Information</i> .	7
2	9/17	Added AEC statement to <i>Features</i> section	1
3	8/19	Updated <i>Typical Operating Characteristics</i>	4, 5
4	11/19	Updated <i>Absolute Maximum Ratings</i> and added new <i>Package Information</i> section	2

For pricing, delivery, and ordering information, please visit Maxim Integrated's online storefront at <https://www.maximintegrated.com/en/storefront/storefront.html>.

Maxim Integrated cannot assume responsibility for use of any circuitry other than circuitry entirely embodied in a Maxim Integrated product. No circuit patent licenses are implied. Maxim Integrated reserves the right to change the circuitry and specifications without notice at any time. The parametric values (min and max limits) shown in the Electrical Characteristics table are guaranteed. Other parametric values quoted in this data sheet are provided for guidance.

# Mouser Electronics

Authorized Distributor

Click to View Pricing, Inventory, Delivery & Lifecycle Information:

[Maxim Integrated:](#)

[MAX6006AEUR+T](#) [MAX6006BEUR+T](#) [MAX6006AESA+](#) [MAX6006AESA+T](#) [MAX6006BESA+](#) [MAX6006BESA+T](#)