

**Table 3. ESD Protection Characteristics**

Test Methodology	Class
Human Body Model (per JESD22-A114)	2 (Minimum)
Machine Model (per EIA/JESD22-A115)	A (Minimum)
Charge Device Model (per JESD22-C101)	IV (Minimum)

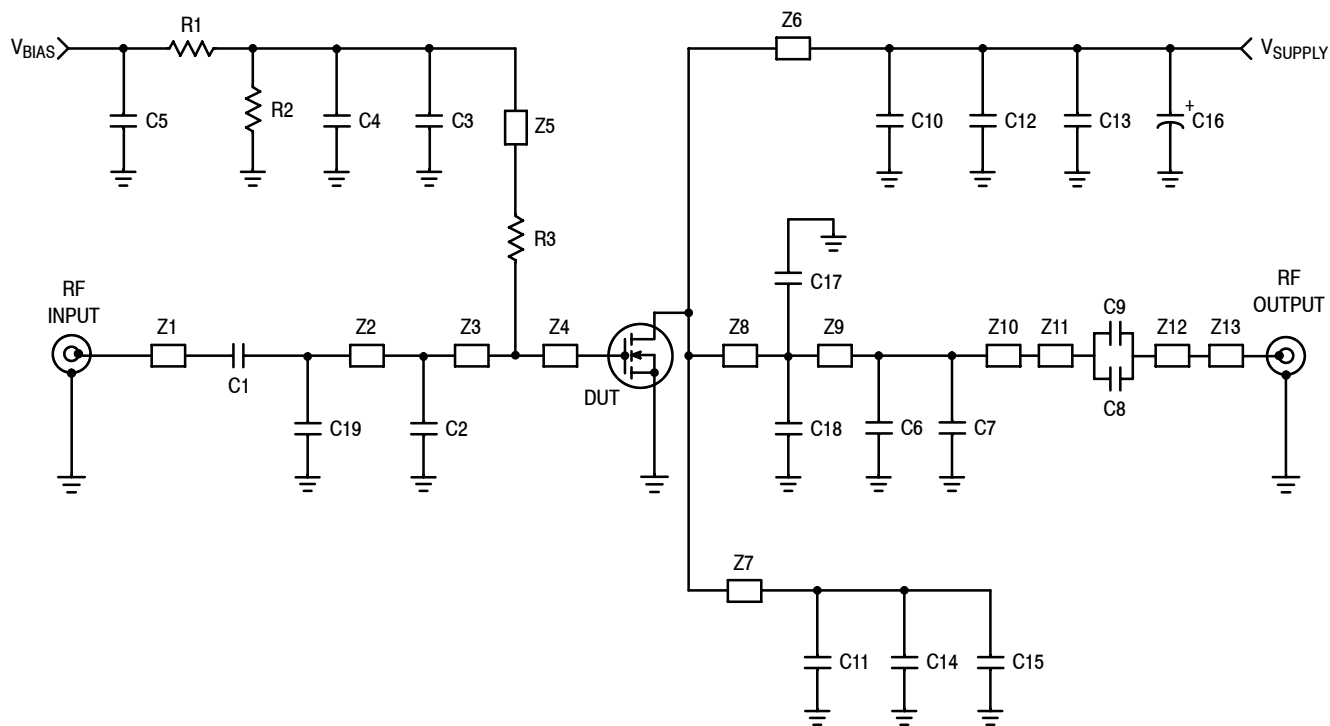
**Table 4. Electrical Characteristics** ( $T_A = 25^\circ\text{C}$  unless otherwise noted)

Characteristic	Symbol	Min	Typ	Max	Unit
<b>Off Characteristics</b>					
Zero Gate Voltage Drain Leakage Current ( $V_{DS} = 68\text{ Vdc}$ , $V_{GS} = 0\text{ Vdc}$ )	$I_{DSS}$	—	—	10	$\mu\text{Adc}$
Zero Gate Voltage Drain Leakage Current ( $V_{DS} = 28\text{ Vdc}$ , $V_{GS} = 0\text{ Vdc}$ )	$I_{DSS}$	—	—	1	$\mu\text{Adc}$
Gate-Source Leakage Current ( $V_{GS} = 5\text{ Vdc}$ , $V_{DS} = 0\text{ Vdc}$ )	$I_{GSS}$	—	—	1	$\mu\text{Adc}$
<b>On Characteristics</b>					
Gate Threshold Voltage ( $V_{DS} = 10\text{ Vdc}$ , $I_D = 300\ \mu\text{Adc}$ )	$V_{GS(th)}$	1	2	3	Vdc
Gate Quiescent Voltage ( $V_{DD} = 28\text{ Vdc}$ , $I_D = 1200\text{ mAdc}$ , Measured in Functional Test)	$V_{GS(Q)}$	2	2.8	4	Vdc
Drain-Source On-Voltage ( $V_{GS} = 10\text{ Vdc}$ , $I_D = 3\text{ Adc}$ )	$V_{DS(on)}$	0.1	0.21	0.3	Vdc
<b>Dynamic Characteristics</b> <sup>(1)</sup>					
Reverse Transfer Capacitance ( $V_{DS} = 28\text{ Vdc} \pm 30\text{ mV(rms)ac}$ @ 1 MHz, $V_{GS} = 0\text{ Vdc}$ )	$C_{rss}$	—	2	—	pF

**Functional Tests** (In Freescale Test Fixture, 50 ohm system)  $V_{DD} = 28\text{ Vdc}$ ,  $I_{DQ} = 1200\text{ mA}$ ,  $P_{out} = 30\text{ W Avg.}$ ,  $f_1 = 2112.5\text{ MHz}$ ,  $f_2 = 2122.5\text{ MHz}$ , 2-carrier W-CDMA, 3.84 MHz Channel Bandwidth Carriers. ACPR measured in 3.84 MHz Channel Bandwidth @  $\pm 5\text{ MHz}$  Offset. IM3 measured in 3.84 MHz Channel Bandwidth @  $\pm 10\text{ MHz}$  Offset. PAR = 8.5 dB @ 0.01% Probability on CCDF.

Power Gain	$G_{ps}$	14.5	15.5	17.5	dB
Drain Efficiency	$\eta_D$	26	27.5	—	%
Intermodulation Distortion	IM3	—	-37	-35	dBc
Adjacent Channel Power Ratio	ACPR	—	-41	-38	dBc
Input Return Loss	IRL	—	-15	-9	dB

1. Part is internally matched both on input and output.

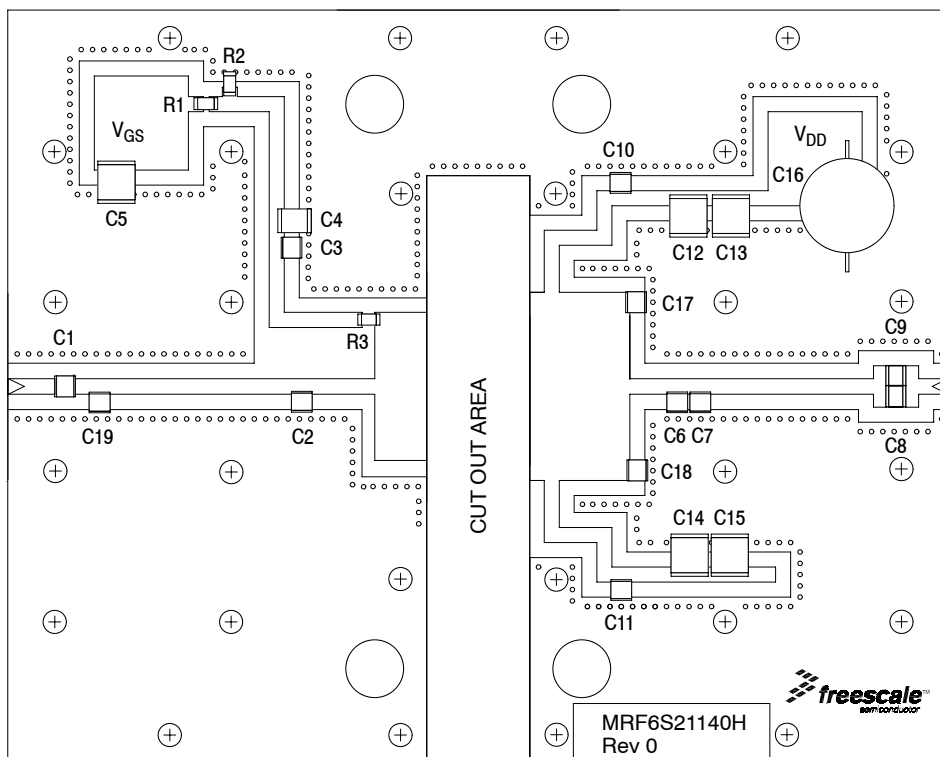


Z1	0.250" x 0.083" Microstrip	Z8	0.531" x 1.000" Microstrip
Z2	1.177" x 0.083" Microstrip	Z9	0.308" x 0.083" Microstrip
Z3	0.443" x 0.083" Microstrip	Z10	0.987" x 0.083" Microstrip
Z4	0.276" x 0.787" Microstrip	Z11, Z12	0.070" x 0.220" Microstrip
Z5	0.786" x 0.083" Microstrip (quarter wave length for bias purpose)	Z13	0.160" x 0.083" Microstrip
Z6, Z7	0.833" x 0.083" Microstrip (quarter wave length for supply purpose)	PCB	Taconic TLX8-0300, 0.030", $\epsilon_r = 2.55$

**Figure 1. MRF6S21140HR3(HSR3) Test Circuit Schematic**

**Table 5. MRF6S21140HR3(HSR3) Test Circuit Component Designations and Values**

Part	Description	Part Number	Manufacturer
C1, C3, C8, C9, C10, C11	6.8 pF Chip Capacitors	ATC100B6R8CT500XT	ATC
C2	0.8 pF Chip Capacitor	ATC100B0R8BT500XT	ATC
C4	220 nF Chip Capacitor	VJ1812Y22YKXCAT	Vishay
C5, C12, C13, C14, C15	10 $\mu$ F Chip Capacitors	C5750X5R1H106MT	TDK
C6, C19	0.2 pF Chip Capacitors	ATC100B0R2BT500XT	ATC
C7	0.5 pF Chip Capacitor	ATC100B0R5BT500XT	ATC
C16	220 $\mu$ F, 63 V Electrolytic Capacitor, Radial	EMVY630ATR221MKE0S	Nippon Chemi-Con
C17, C18	0.1 pF Chip Capacitors	ATC100B0R1BT500XT	ATC
R1, R2	10 k $\Omega$ , 1/4 W Chip Resistors	CRCW12061002FKTA	Vishay
R3	10 $\Omega$ , 1/4 W Chip Resistor	CRCW120610R0FKTA	Vishay



**Figure 2. MRF6S21140HR3(HSR3) Test Circuit Component Layout**

### TYPICAL CHARACTERISTICS

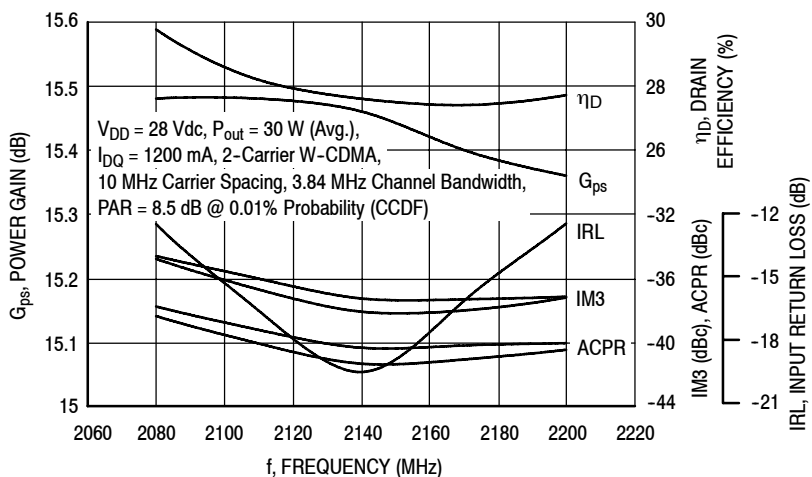


Figure 3. 2-Carrier W-CDMA Broadband Performance @  $P_{out} = 30$  Watts Avg.

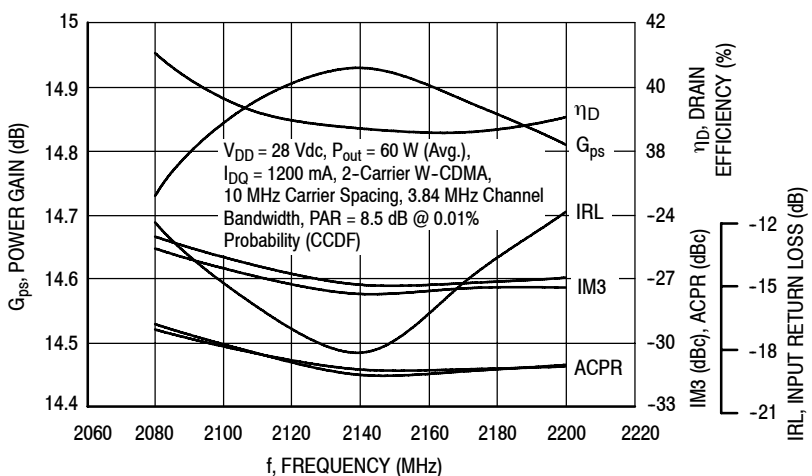


Figure 4. 2-Carrier W-CDMA Broadband Performance @  $P_{out} = 60$  Watts Avg.

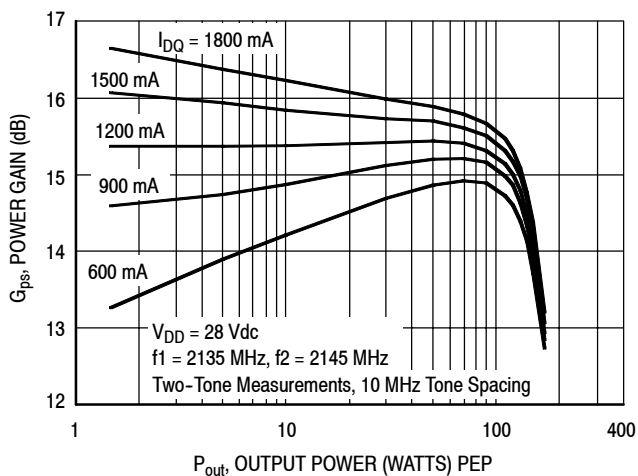


Figure 5. Two-Tone Power Gain versus Output Power

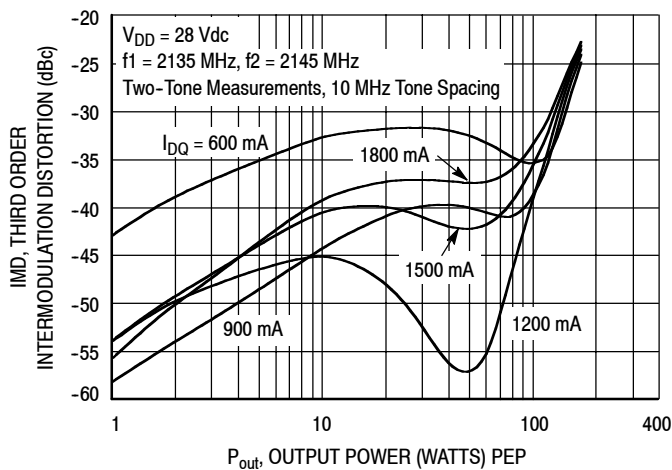
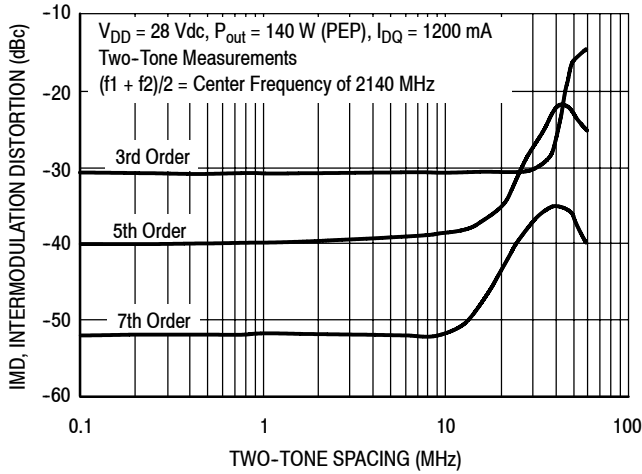
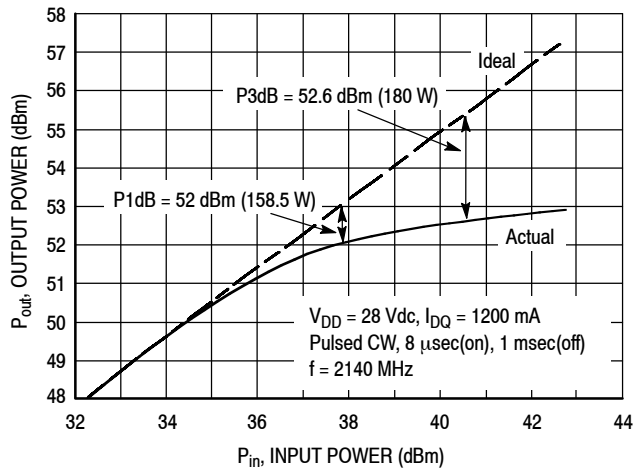


Figure 6. Third Order Intermodulation Distortion versus Output Power

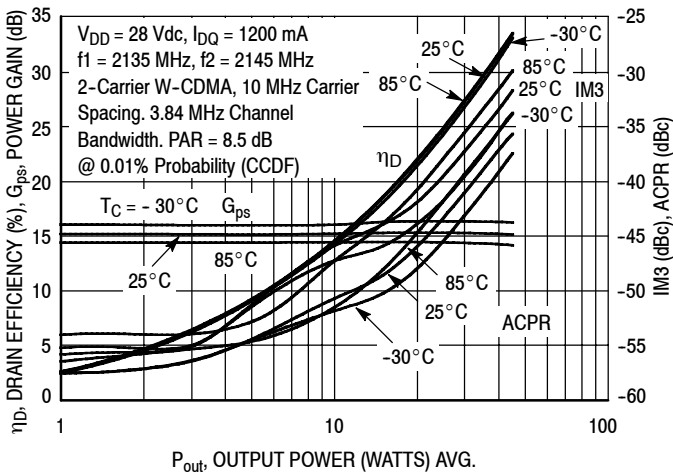
## TYPICAL CHARACTERISTICS



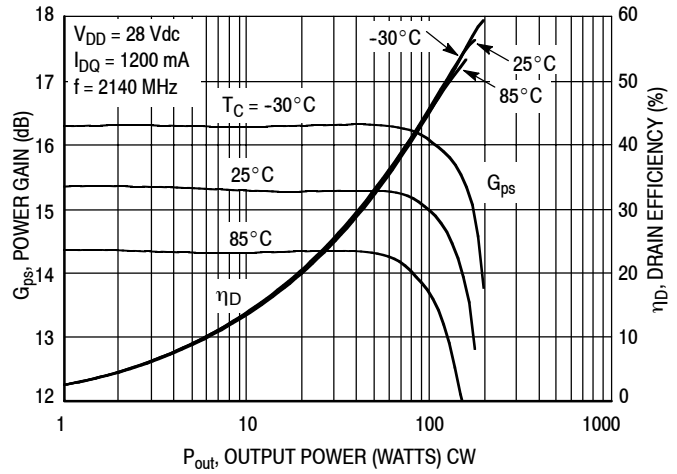
**Figure 7. Intermodulation Distortion Products versus Tone Spacing**



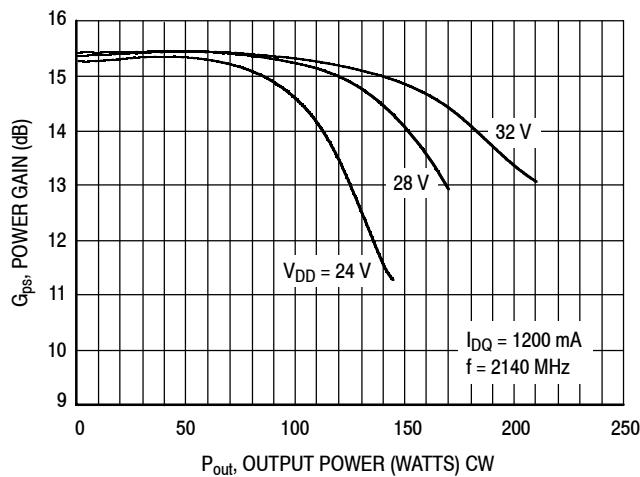
**Figure 8. Pulsed CW Output Power versus Input Power**



**Figure 9. 2-Carrier W-CDMA ACPR, IM3, Power Gain and Drain Efficiency versus Output Power**

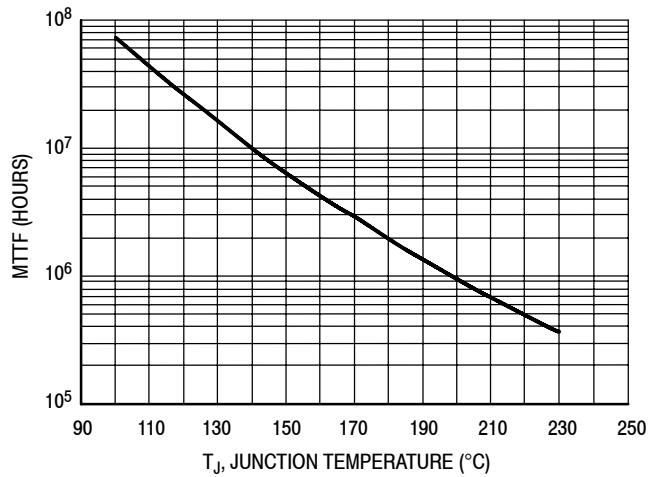


**Figure 10. Power Gain and Drain Efficiency versus CW Output Power**



**Figure 11. Power Gain versus Output Power**

## TYPICAL CHARACTERISTICS

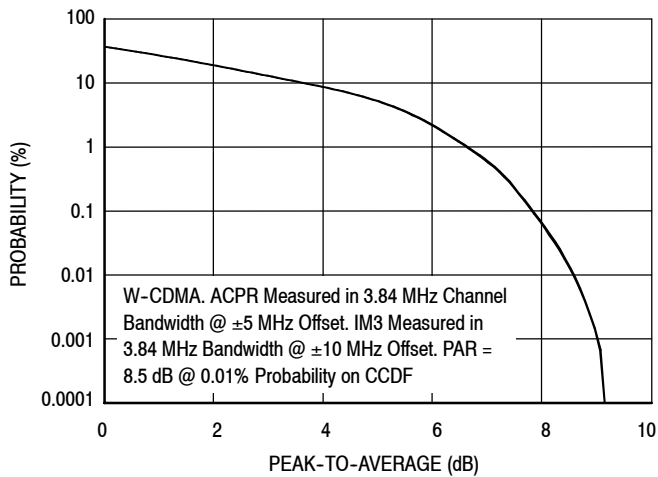


This above graph displays calculated MTTF in hours when the device is operated at  $V_{DD} = 28$  Vdc,  $P_{out} = 30$  W Avg., and  $\eta_D = 27.5\%$ .

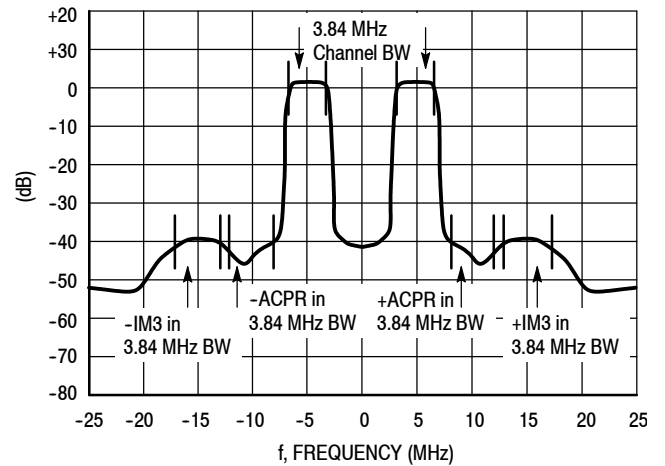
MTTF calculator available at <http://www.freescale.com/rf>. Select Tools/Software/Application Software/Calculators to access the MTTF calculators by product.

**Figure 12. MTTF versus Junction Temperature**

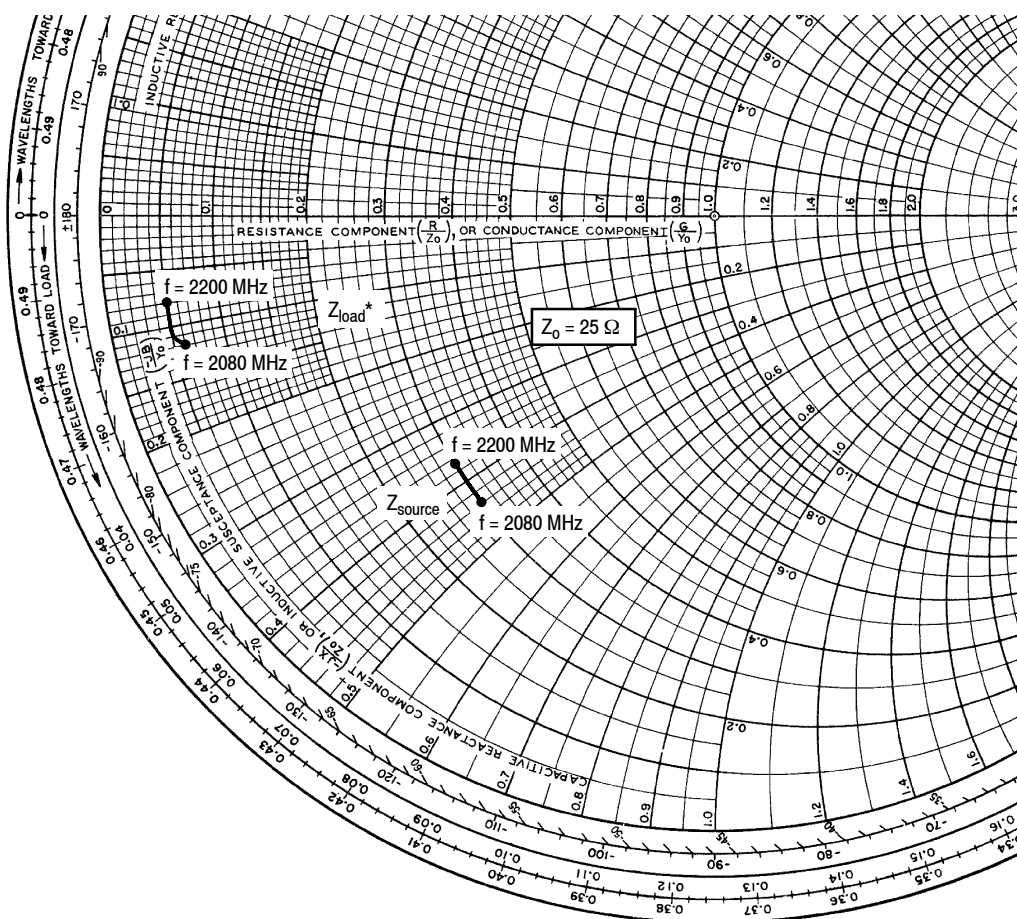
## W-CDMA TEST SIGNAL



**Figure 13. CCDF W-CDMA 3GPP, Test Model 1, 64 DPCH, 67% Clipping, Single-Carrier Test Signal**



**Figure 14. 2-Carrier W-CDMA Spectrum**



$V_{DD} = 28 \text{ Vdc}$ ,  $I_{DQ} = 1200 \text{ mA}$ ,  $P_{out} = 30 \text{ W Avg.}$

f MHz	Z <sub>source</sub> Ω	Z <sub>load</sub> Ω
2080	7.53 - j10.99	1.40 - j3.03
2110	7.57 - j10.67	1.37 - j2.78
2140	7.58 - j10.23	1.34 - j2.52
2170	7.51 - j9.73	1.32 - j2.28
2200	7.44 - j9.32	1.31 - j2.06

Z<sub>source</sub> = Test circuit impedance as measured from gate to ground.

Z<sub>load</sub> = Test circuit impedance as measured from drain to ground.

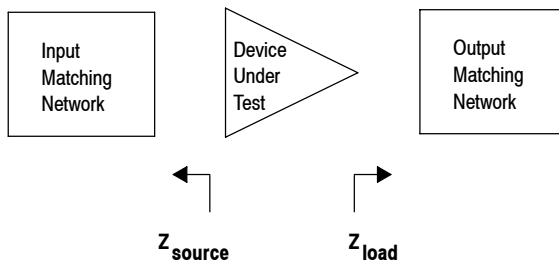
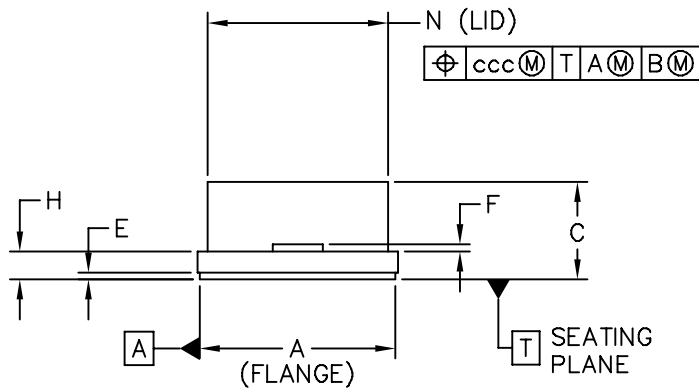
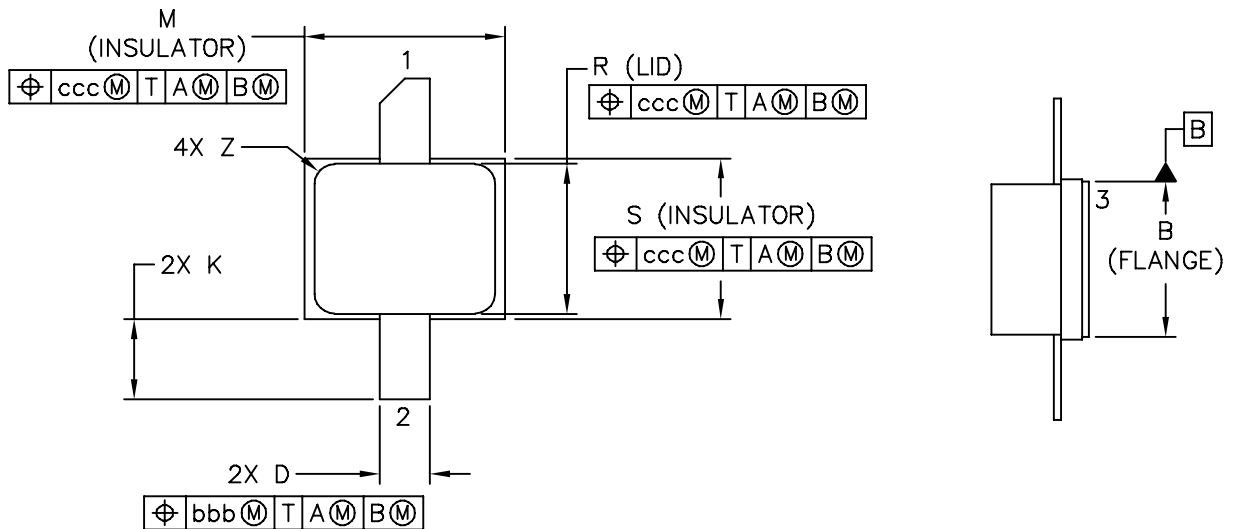


Figure 15. Series Equivalent Source and Load Impedance

### PACKAGE DIMENSIONS



© FREESCALE SEMICONDUCTOR, INC. ALL RIGHTS RESERVED.	<b>MECHANICAL OUTLINE</b>	PRINT VERSION NOT TO SCALE	
TITLE: NI-200S STRAIGHT LEAD		DOCUMENT NO: 98ARH98343A	REV: E
		CASE NUMBER: 458B-03	22 MAR 2005
		STANDARD: NON-JEDEC	



NOTES:

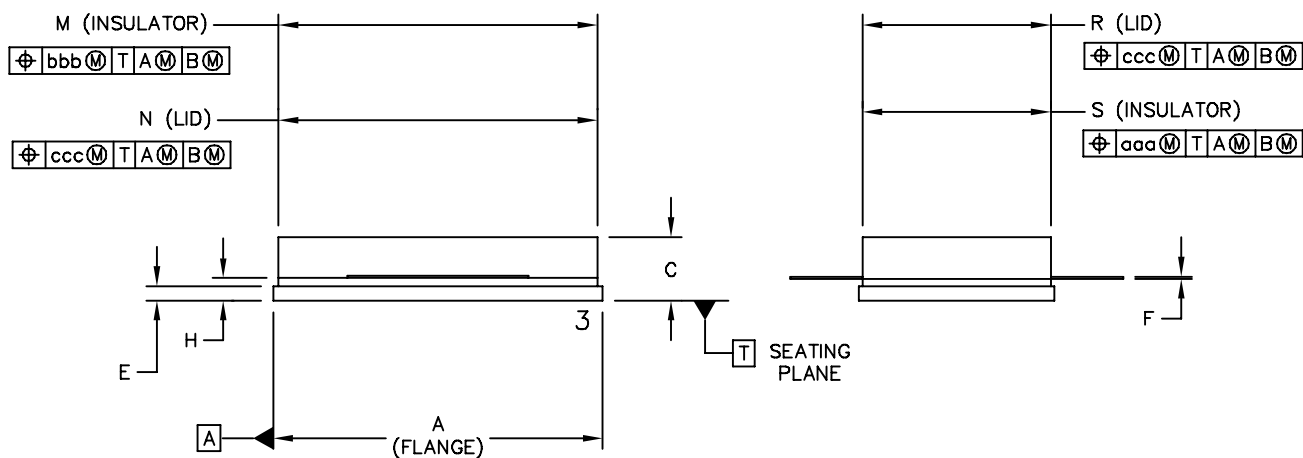
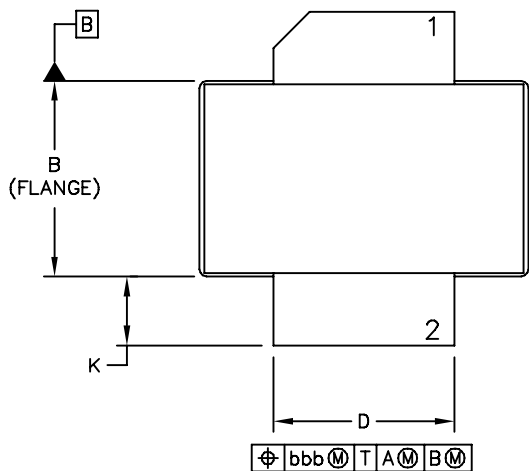
1. CONTROLLING DIMENSION: INCH
2. INTERPRET DIMENSIONS AND TOLERANCES PER ASME Y14.5M-1994.
3. DELETED.
4. DIMENSION "H" TO BE MEASURED .030 (0.762) FROM PACKAGE BODY.

STYLE 1:

- PIN 1: DRAIN
- PIN 2: GATE
- PIN 3: SOURCE

DIM	INCH		MILLIMETER		DIM	INCH		MILLIMETER	
	MIN	MAX	MIN	MAX		MIN	MAX	MIN	MAX
A	.180	.190	4.572	4.83	Z	-	R .020	-	R 0.508
B	.140	.150	3.556	3.81	bbb	.010	-	0.254	-
C	.082	.116	2.083	2.946	ccc	.015	-	0.381	-
D	.047	.053	1.194	1.346	-	-	-	-	-
E	.004	.010	0.102	0.254	-	-	-	-	-
F	.004	.006	0.102	0.152	-	-	-	-	-
H	.025	.031	0.635	0.787	-	-	-	-	-
K	.060	.110	1.524	2.794	-	-	-	-	-
M	.197	.203	5.004	5.156	-	-	-	-	-
N	.177	.183	4.496	4.648	-	-	-	-	-
R	.147	.153	3.734	3.886	-	-	-	-	-
S	.157	.163	3.988	4.14	-	-	-	-	-

© FREESCALE SEMICONDUCTOR, INC. ALL RIGHTS RESERVED.	<b>MECHANICAL OUTLINE</b>	PRINT VERSION NOT TO SCALE
TITLE:  NI-200S STRAIGHT LEAD	DOCUMENT NO: 98ARH98434A	REV: E
	CASE NUMBER: 458B-03	22 MAR 2005
	STANDARD: NON-JEDEC	



© FREESCALE SEMICONDUCTOR, INC. ALL RIGHTS RESERVED.		<b>MECHANICAL OUTLINE</b>		PRINT VERSION NOT TO SCALE	
TITLE:  NI-880S		DOCUMENT NO: 98ARB18660C		REV: D	
		CASE NUMBER: 465C-02		09 JUN 2005	
		STANDARD: NON-JEDEC			

NOTES:

1. DIMENSIONING AND TOLERANCING PER ANSI Y14.5M-1994.
2. CONTROLLING DIMENSION: INCH.
3. DIMENSION H IS MEASURED .030 (0.762) AWAY FROM PACKAGE BODY.

STYLE 1:   PIN 1. DRAIN  
                   2. GATE  
                   3. SOURCE

DIM	INCH		MILLIMETER		DIM	INCH		MILLIMETER	
	MIN	MAX	MIN	MAX		MIN	MAX	MIN	MAX
A	.905	-.915	22.99	- 23.24	aaa	- .007	-	- 0.178	-
B	.535	-.545	13.6	- 13.8	bbb	- .010	-	- 0.254	-
C	.147	-.200	3.73	- 5.08	ccc	- .015	-	- 0.381	-
D	.495	-.505	12.57	- 12.83	-	-	-	-	-
E	.035	-.045	0.89	- 1.14	-	-	-	-	-
F	.003	-.006	0.08	- 0.15	-	-	-	-	-
H	.057	.067	1.45	1.7	-	-	-	-	-
K	.170	-.210	4.32	- 5.33	-	-	-	-	-
M	.872	-.888	22.15	- 22.55	-	-	-	-	-
N	.871	-.889	19.3	- 22.6	-	-	-	-	-
R	.515	-.525	13.1	- 13.3	-	-	-	-	-
S	.515	-.525	13.1	- 13.3	-	-	-	-	-

© FREESCALE SEMICONDUCTOR, INC. ALL RIGHTS RESERVED.		<b>MECHANICAL OUTLINE</b>		PRINT VERSION NOT TO SCALE	
TITLE:  NI-880S		DOCUMENT NO: 98ARB18660C		REV: D	
		CASE NUMBER: 465C-02		09 JUN 2005	
		STANDARD: NON-JEDEC			

Refer to the following documents to aid your design process.

**Application Notes**

- AN1955: Thermal Measurement Methodology of RF Power Amplifiers

**Engineering Bulletins**

- EB212: Using Data Sheet Impedances for RF LDMOS Devices

**Software**

- Electromigration MTTF Calculator
- RF High Power Model

For Software and Tools, do a Part Number search at <http://www.freescale.com>, and select the “Part Number” link. Go to the Software & Tools tab on the part’s Product Summary page to download the respective tool.

**REVISION HISTORY**

The following table summarizes revisions to this document.

Revision	Date	Description
4	May 2007	<ul style="list-style-type: none"> <li>• Removed Lower Thermal Resistance and Low Gold Plating bullets from Features section as functionality is standard, p. 1</li> <li>• Removed “Designed for Lower Memory Effects and Wide Instantaneous Bandwidth Applications” bullet as functionality is standard, p. 1</li> <li>• Added “Optimized for Doherty Applications” bullet to Features section, p. 1</li> <li>• Removed Total Device Dissipation from Max Ratings table as data was redundant (information already provided in Thermal Characteristics table), p. 1</li> <li>• Operating Junction Temperature increased from 200°C to 225°C in Maximum Ratings table and related “Continuous use at maximum temperature will affect MTTF” footnote added, p. 1</li> <li>• Corrected <math>V_{DS}</math> to <math>V_{DD}</math> in the RF test condition voltage callout for <math>V_{GS(Q)}</math> and added “Measured in Functional Test”, On Characteristics table, p. 2</li> <li>• Removed Forward Transconductance from On Characteristics table as it no longer provided usable information, p. 2</li> <li>• Updated Part Numbers in Table 5, Component Designations and Values, to RoHS compliant part numbers, p. 3</li> <li>• Adjusted scale for Fig. 5, Two-Tone Power Gain versus Output Power, to better match the device’s capabilities, p. 5</li> <li>• Removed lower voltage tests from Fig. 11, Power Gain versus Output Power, due to fixed tuned fixture limitations, p. 6</li> <li>• Replaced Fig. 12, MTTF versus Junction Temperature with updated graph. Removed Amps<sup>2</sup> and listed operating characteristics and location of MTTF calculator for device, p. 7</li> <li>• Added Product Documentation and Revision History, p. 10</li> </ul>
5	Feb. 2010	<ul style="list-style-type: none"> <li>• Modified data sheet to reflect RF Test Reduction described in Product and Process Change Notification number, PCN13232, p. 1, 2</li> <li>• Added On Characteristic <math>V_{DS(on)}</math> Min value, p. 2</li> <li>• Added Electromigration MTTF Calculator and RF High Power Model availability to Product Software, p. 13</li> </ul>

## **How to Reach Us:**

### **Home Page:**

[www.freescale.com](http://www.freescale.com)

### **Web Support:**

<http://www.freescale.com/support>

### **USA/Europe or Locations Not Listed:**

Freescale Semiconductor, Inc.  
Technical Information Center, EL516  
2100 East Elliot Road  
Tempe, Arizona 85284  
1-800-521-6274 or +1-480-768-2130  
[www.freescale.com/support](http://www.freescale.com/support)

### **Europe, Middle East, and Africa:**

Freescale Halbleiter Deutschland GmbH  
Technical Information Center  
Schatzbogen 7  
81829 Muenchen, Germany  
+44 1296 380 456 (English)  
+46 8 52200080 (English)  
+49 89 92103 559 (German)  
+33 1 69 35 48 48 (French)  
[www.freescale.com/support](http://www.freescale.com/support)

### **Japan:**

Freescale Semiconductor Japan Ltd.  
Headquarters  
ARCO Tower 15F  
1-8-1, Shimo-Meguro, Meguro-ku,  
Tokyo 153-0064  
Japan  
0120 191014 or +81 3 5437 9125  
[support.japan@freescale.com](mailto:support.japan@freescale.com)

### **Asia/Pacific:**

Freescale Semiconductor China Ltd.  
Exchange Building 23F  
No. 118 Jianguo Road  
Chaoyang District  
Beijing 100022  
China  
+86 10 5879 8000  
[support.asia@freescale.com](mailto:support.asia@freescale.com)

### **For Literature Requests Only:**

Freescale Semiconductor Literature Distribution Center  
1-800-441-2447 or +1-303-675-2140  
Fax: +1-303-675-2150  
[LDCForFreescaleSemiconductor@hibbertgroup.com](mailto:LDCForFreescaleSemiconductor@hibbertgroup.com)

Information in this document is provided solely to enable system and software implementers to use Freescale Semiconductor products. There are no express or implied copyright licenses granted hereunder to design or fabricate any integrated circuits or integrated circuits based on the information in this document.

Freescale Semiconductor reserves the right to make changes without further notice to any products herein. Freescale Semiconductor makes no warranty, representation or guarantee regarding the suitability of its products for any particular purpose, nor does Freescale Semiconductor assume any liability arising out of the application or use of any product or circuit, and specifically disclaims any and all liability, including without limitation consequential or incidental damages. "Typical" parameters that may be provided in Freescale Semiconductor data sheets and/or specifications can and do vary in different applications and actual performance may vary over time. All operating parameters, including "Typicals", must be validated for each customer application by customer's technical experts. Freescale Semiconductor does not convey any license under its patent rights nor the rights of others. Freescale Semiconductor products are not designed, intended, or authorized for use as components in systems intended for surgical implant into the body, or other applications intended to support or sustain life, or for any other application in which the failure of the Freescale Semiconductor product could create a situation where personal injury or death may occur. Should Buyer purchase or use Freescale Semiconductor products for any such unintended or unauthorized application, Buyer shall indemnify and hold Freescale Semiconductor and its officers, employees, subsidiaries, affiliates, and distributors harmless against all claims, costs, damages, and expenses, and reasonable attorney fees arising out of, directly or indirectly, any claim of personal injury or death associated with such unintended or unauthorized use, even if such claim alleges that Freescale Semiconductor was negligent regarding the design or manufacture of the part.

Freescale™ and the Freescale logo are trademarks of Freescale Semiconductor, Inc. All other product or service names are the property of their respective owners.

© Freescale Semiconductor, Inc. 2004-2007, 2010. All rights reserved.

# Mouser Electronics

Authorized Distributor

Click to View Pricing, Inventory, Delivery & Lifecycle Information:

[NXP:](#)

[MRF6S21140HR3](#)