

Absolute Maximum Rating

Characteristics	Symbol	Rating	Unit
VCC Pin Voltage	V_{CC}	$V_{SS} - 0.3$ to $V_{SS} + 26$	V
Feedback Pin Voltage	V_{FB}	$V_{SS} - 0.3$ to 12	V
EN Voltage	V_{EN}	$V_{SS} - 0.3$ to VCC	V
SENSE Voltage	V_{SENSE}	$V_{SS} - 0.3$ to VCC	V
SS Pin Voltage	V_{SS}	$V_{SS} - 0.3$ to VCC	V
Gate Pin Voltage	V_{GATE}	$V_{SS} - 0.3$ to VCC	V
Power Dissipation	P_D	Internally limited	mW
Storage Temperature Range	T_{STG}	-40 to +150	°C
Operating Junction Temperature Range	T_{OPJ}	-20 to +125	°C
Operating Supply Voltage	V_{OP}	+3 to +24	V
Thermal Resistance from Junction to case	θ_{JC}	40	°C/W
Thermal Resistance from Junction to ambient	θ_{JA}	120	°C/W

Note: Stresses exceed those rating may damage the device

Electrical Specifications ($T_A=25^\circ\text{C}$, $V_{IN}=5\text{V}$, $V_{OUT}=12\text{V}$ unless otherwise noted)

Characteristics	Symbol	Conditions	Min	Typ	Max	Units
Feedback Voltage	V_{FB}	$I_{OUT}=0.1\text{A}$	0.975	1.000	1.025	V
Quiescent Current	I_{CCQ}	$V_{FB}=1.5\text{V}$ force driver off	-	4	6	mA
Feedback Bias Current	I_{FB}	$I_{OUT}=0.1\text{A}$	-	0.1	0.5	uA
Shutdown Supply Current	I_{SD}	$V_{EN}=0\text{V}$	-	1	10	uA
Oscillation Frequency	F_{OSC}	SW pin	400	500	600	KHz
Sense Voltage	V_{SENSE}		0.05	0.06	0.07	V
Soft Start Current	I_{SS}	$V_{SS}=0\text{V}$	-	8	-	uA
EN Pin Logic input threshold voltage	V_{SH}	High (regulator ON)	2.0	-	-	V
	V_{SL}	Low (regulator OFF)	-	-	0.8	
EN Pin Input Current	I_{SH}	$V_{EN}=2.5\text{V}$ (ON)	-	20	-	uA
	I_{SL}	$V_{EN}=0.3\text{V}$ (OFF)	-	-1	-	uA
LX Rise Time	T_{LXR}	$C_{LX}=1000\text{pF}$	-	60	-	nS
LX Fall Time	T_{LXF}	$C_{LX}=1000\text{pF}$	-	60	-	
Efficiency	EFFI	$V_{CC} = 5\text{V}$, $V_{OUT} = 12\text{V}$ $I_{OUT} = 1\text{A}$	-	91	-	%
Maximum Duty Cycle	DC_{MAX}	$V_{FB}=0\text{V}$	-	85	-	%
Minimum Duty Cycle	DC_{MIN}	$V_{FB}=1.5\text{V}$	-	0	-	
Thermal shutdown Temp	TSD		-	145	-	°C

Block Diagram

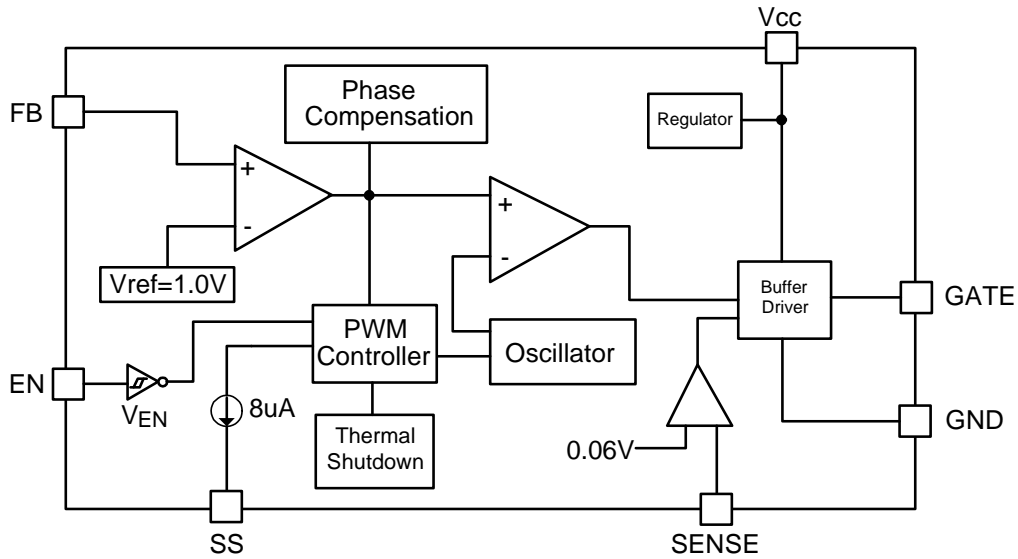

Pin Function Description

Pin NO.	Pin Name	Pin Description
1	EN	Shutdown Control Input H: Normal Operation L: Shutdown Mode
2	V _{CC}	VCC Supply pin
3	FB	Feedback Pin
4	SS	Soft-Start pin
5	V _{SENSE}	Current Limit Sense Voltage
6	Gate	Gate drive for external N-CH MOSFET
7	GND	Signal Ground Pin
8	NC	Non Connect

Function Description

PWM Control

The TS19375 is high efficient PWM step-up controller, the pulse width varies in a range from 0 to 85%. According to the load current, the ripple voltage produced by the switching can easily be removed through a filter because the switching frequency remains constant. Therefore, TS19375 provide a low-ripple power over broad ranges of input voltage and load current.

Setting the Output Voltage

Application circuit shows the basic application circuit with adjustable output version. The external resistor sets the output voltage according to the following formula:

$$V_{OUT} = V_{FB} \times \left(1 + \frac{R1}{R2}\right)$$

Table 1: Resistor select for output voltage setting

V _{OUT}	R2	R1
12V	1K	11K
15V	1.5K	21K
18V	1K	17K
24V	1.3K	30K

Current Limit Setting

The current limit threshold is setting by the external resistor (R_{SENSE}) connecting from SENSE pin to GND (refer the application circuit). The internal current limit compared voltage is 60mV. When the SENSE voltage is larger than 60mV, an over-current condition is triggered. Please refer to the formula for setting the minimum current limit value:

$$I_{SW(MAX)} = \frac{60mV}{R_{SENSE}}$$

Note: I_{SW(MAX)} is the maximum N-MOSFET current

Inductor Selection

For most designs, Low inductance values are physically smaller but require faster switching, which results in some efficiency loss. The inductor value can be derived from the following formula:

$$L = \frac{V_{IN} \times (V_{OUT} - V_{IN})}{V_{OUT} \times \Delta L \times FLX}$$

Large value inductors lower ripple current and small value inductors result in high ripple currents. Choose inductor ripple current approximately 15% of the maximum input current 3A, ΔIL=0.45A.

Table 2: Inductor select for output voltage setting (V_{CC}=5V)

V _{OUT}	9V	12V	15V	18V
L1 Value	18uH	15uH	10uH	10uH

The DC current rating of the inductor should be at least equal to the maximum load current plus half the ripple current to prevent core saturation (3A+0.25A).

Function Description (Continue)

Input Capacitor Selection

The input capacitor reduces the surge current drawn from the input and switching noise from the device. The input capacitor impedance at the switching frequency shall be less than input source impedance to prevent high frequency switching current passing to the input. A low ESR input capacitor sized for maximum RMS current must be used.

The capacitor voltage rating should be at least 1.5 times greater than the input voltage, and often much higher voltage ratings are needed to satisfy.

Output Capacitor Selection

The output capacitor is required to keep the output voltage ripple small and to ensure regulation loop stability. The output capacitor must have low impedance at the switching frequency. A low ESR capacitor sized for maximum RMS current must be used. The low ESR requirements needed for low output ripple voltage. The capacitor voltage rating should be at least 1.5 times greater than the input voltage, and often much higher voltage ratings are needed to satisfy.

The ESR range of output capacitor is 30m~100m Ω at switch current more than 1.5A. Add a 4.7uF output bypass capacitor in order to reduce output ripple effectively

Electrical Characteristics Curve ($T_A=25^\circ\text{C}$, $V_{IN}=5\text{V}$, $V_{\text{FORWARD-LED}}=3.3\text{V}$, unless otherwise noted)

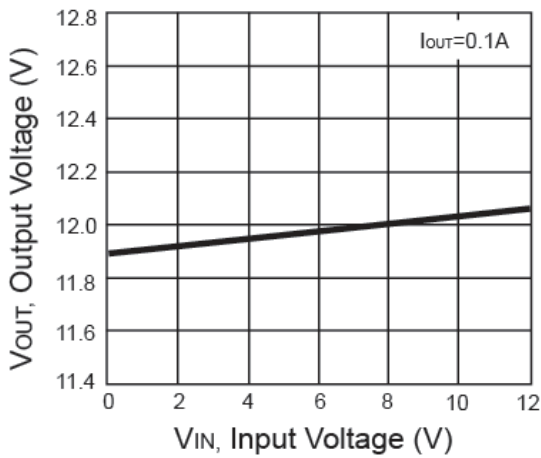

Input Voltage vs. Output Voltage

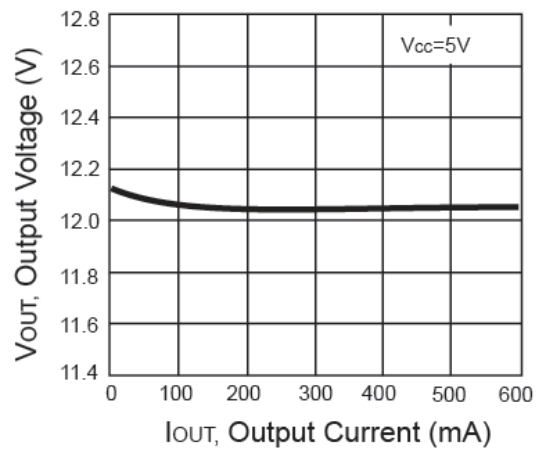

Output Current vs. Output Voltage

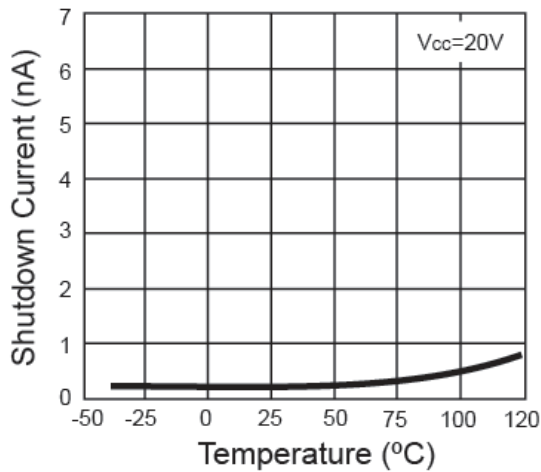

Shutdown Current vs. Temperature

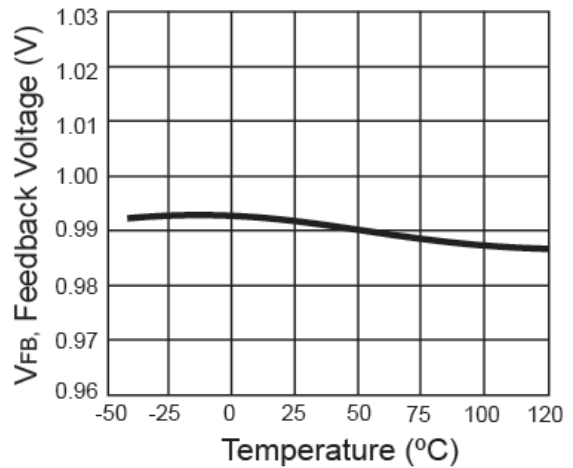

Feedback Voltage vs. Temperature

SOP-8 Mechanical Drawing

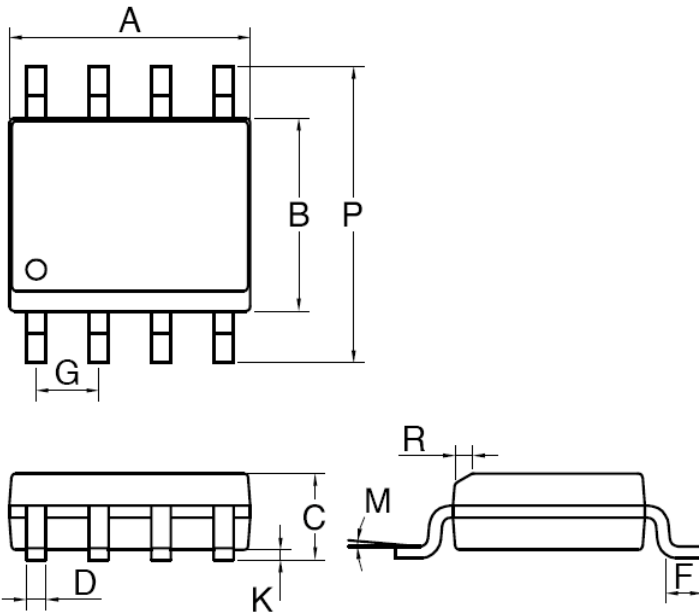

DIM	MILLIMETERS		INCHES	
	MIN	MAX	MIN	MAX.
A	4.80	5.00	0.189	0.196
B	3.80	4.00	0.150	0.157
C	1.35	1.75	0.054	0.068
D	0.35	0.49	0.014	0.019
F	0.40	1.25	0.016	0.049
G	1.27BSC		0.05BSC	
K	0.10	0.25	0.004	0.009
M	0°	7°	0°	7°
P	5.80	6.20	0.229	0.244
R	0.25	0.50	0.010	0.019

Marking Diagram

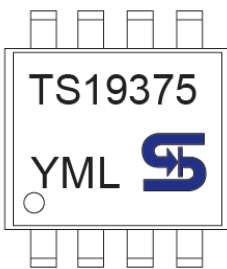

- Y** = Year Code
- M** = Month Code for Halogen Free Product
(**O**=Jan, **P**=Feb, **Q**=Mar, **R**=Apr, **S**=May, **T**=Jun, **U**=Jul, **V**=Aug, **W**=Sep, **X**=Oct, **Y**=Nov, **Z**=Dec)
- L** = Lot Code

Notice

Specifications of the products displayed herein are subject to change without notice. TSC or anyone on its behalf, assumes no responsibility or liability for any errors or inaccuracies.

Information contained herein is intended to provide a product description only. No license, express or implied, to any intellectual property rights is granted by this document. Except as provided in TSC's terms and conditions of sale for such products, TSC assumes no liability whatsoever, and disclaims any express or implied warranty, relating to sale and/or use of TSC products including liability or warranties relating to fitness for a particular purpose, merchantability, or infringement of any patent, copyright, or other intellectual property right.

The products shown herein are not designed for use in medical, life-saving, or life-sustaining applications. Customers using or selling these products for use in such applications do so at their own risk and agree to fully indemnify TSC for any damages resulting from such improper use or sale.

Mouser Electronics

Authorized Distributor

Click to View Pricing, Inventory, Delivery & Lifecycle Information:

[Taiwan Semiconductor:](#)

[TS19375CS RLG](#)