

Electrical Characteristics(Ta = 25C) °

Part Number	Marking Code	Zener Voltage			Operating resistance		Rising operating Resistance		Reverse current	
		Vz(V)			ZZT(Ohm)		ZZK(Ohm)		IR(uA)	
		Min	Max	Iz(mA)	Max	Iz(mA)	Max	Iz(mA)	Max	VR(V)
CZRU52C2-HF	Z0	1.90	2.10	5	100	5	600	1	100	1
CZRU52C2V2-HF	Z1	2.09	2.31	5	100	5	600	1	100	1
CZRU52C2V4-HF	Z2	2.28	2.52	5	85	5	600	1	100	1
CZRU52C2V7-HF	Z3	2.57	2.84	5	83	5	500	1	75	1
CZRU52C3-HF	Z4	2.85	3.15	5	95	5	500	1	50	1
CZRU52C3V3-HF	Z5	3.14	3.47	5	95	5	500	1	25	1
CZRU52C3V6-HF	Z6	3.42	3.78	5	95	5	500	1	15	1
CZRU52C3V9-HF	Z7	3.71	4.10	5	95	5	500	1	10	1
CZRU52C4V3-HF	Z8	4.09	4.52	5	95	5	500	1	5	1
CZRU52C4V7-HF	Z9	4.47	4.94	5	78	5	500	1	5	2
CZRU52C5V1-HF	ZA	4.85	5.36	5	60	5	480	1	0.1	0.8
CZRU52C5V6-HF	ZB	5.32	5.88	5	40	5	400	1	0.1	1
CZRU52C6V2-HF	ZC	5.89	6.51	5	10	5	200	1	0.1	2
CZRU52C6V8-HF	ZE	6.46	7.14	5	8	5	150	1	0.1	3
CZRU52C7V5-HF	ZF	7.13	7.88	5	7	5	50	1	0.1	5
CZRU52C8V2-HF	ZG	7.79	8.61	5	7	5	50	1	0.1	6
CZRU52C9V1-HF	ZH	8.65	9.56	5	10	5	50	1	0.1	7
CZRU52C10-HF	ZJ	9.50	10.50	5	15	5	70	1	0.1	7.5
CZRU52C11-HF	ZK	10.45	11.55	5	20	5	70	1	0.1	8.5
CZRU52C12-HF	ZM	11.40	12.60	5	20	5	90	1	0.1	9
CZRU52C13-HF	ZN	12.35	13.65	5	25	5	110	1	0.1	10
CZRU52C15-HF	ZP	14.25	15.75	5	30	5	110	1	0.1	11
CZRU52C16-HF	ZQ	15.20	16.80	5	40	5	170	1	0.1	12
CZRU52C18-HF	ZR	17.10	18.90	5	50	5	170	1	0.1	14
CZRU52C20-HF	ZS	19.00	21.00	5	50	5	220	1	0.1	15
CZRU52C22-HF	ZT	20.90	23.10	5	55	5	220	1	0.1	17
CZRU52C24-HF	ZU	22.80	25.20	5	80	5	220	1	0.1	18
CZRU52C27-HF	ZV	25.65	28.35	5	80	5	250	1	0.1	20
CZRU52C30-HF	ZW	28.50	31.50	5	80	5	250	1	0.1	23
CZRU52C33-HF	ZX	31.35	34.65	5	80	5	250	1	0.1	25
CZRU52C36-HF	ZY	34.20	37.80	5	90	5	250	1	0.1	27
CZRU52C39-HF	ZZ	37.05	40.95	5	90	5	300	1	0.1	29

RATING AND CHARACTERISTIC CURVES (CZRU52C2-HF Thru CZRU52C39-HF)

Fig.1 TEMPERATURE COEFFICIENTS

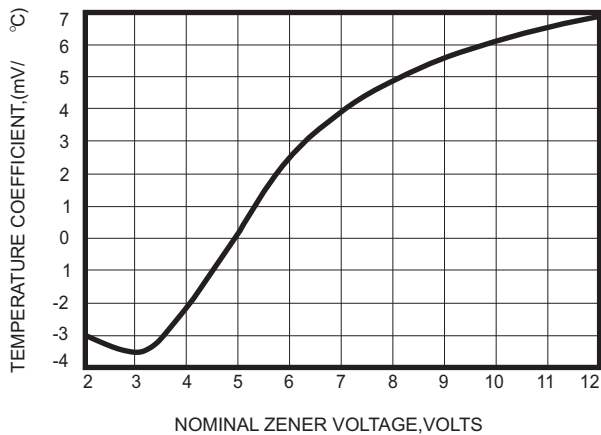

Fig.2 TEMPERATURE COEFFICIENTS

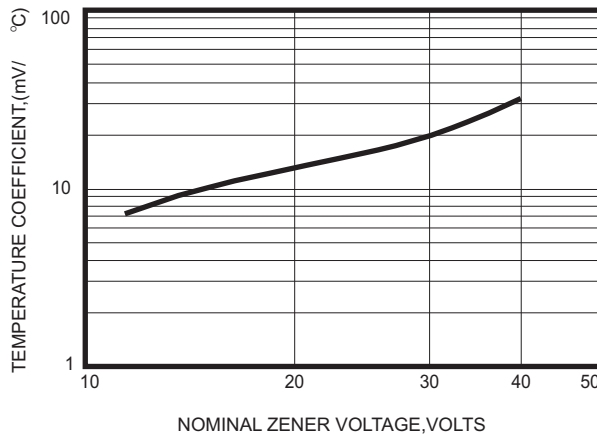

Fig.3 EFFECT OF ZENER VOLTAGE ON ZENER IMPEDANCE

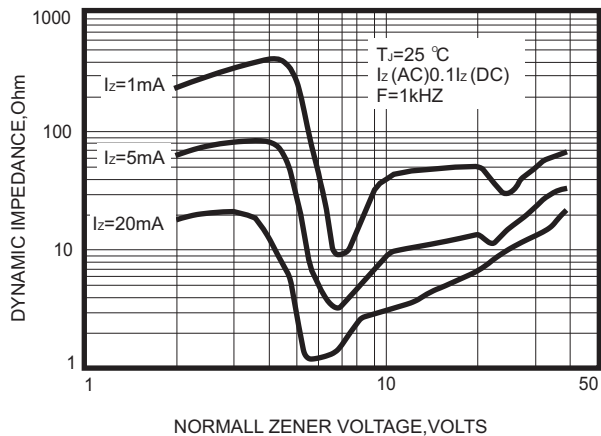

Fig.4 TYPICAL FORWARD VOLTAGE

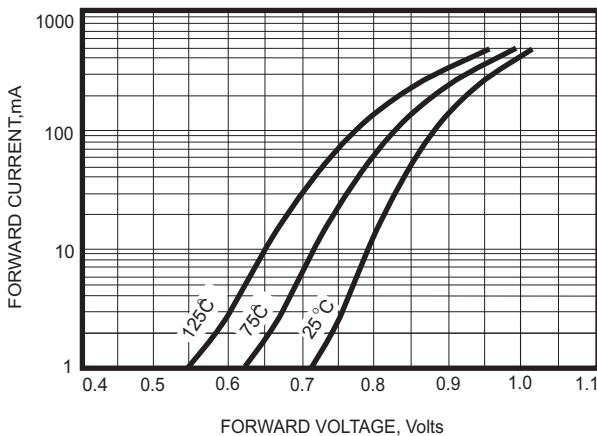

Fig.5 TYPICAL LEAKAGE CURRENT

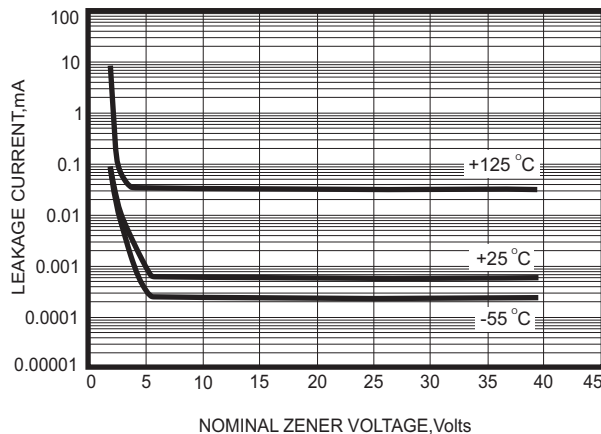
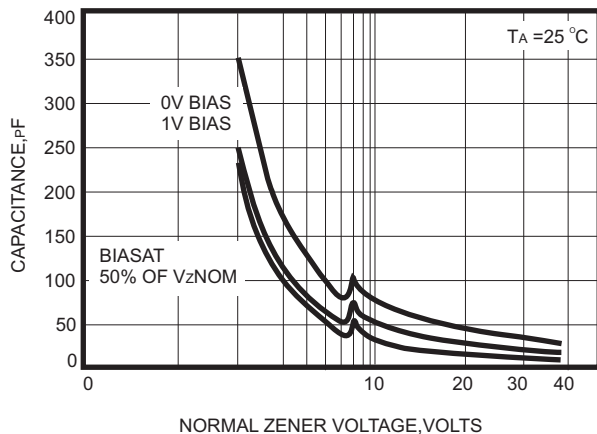

Fig.6 TYPICAL CAPACITANCE



RATING AND CHARACTERISTIC CURVES (CZRU52C2-HF Thru CZRU52C39-HF)

Fig.7 ZENER VOLTAGE VERSUS ZENER CURRENT

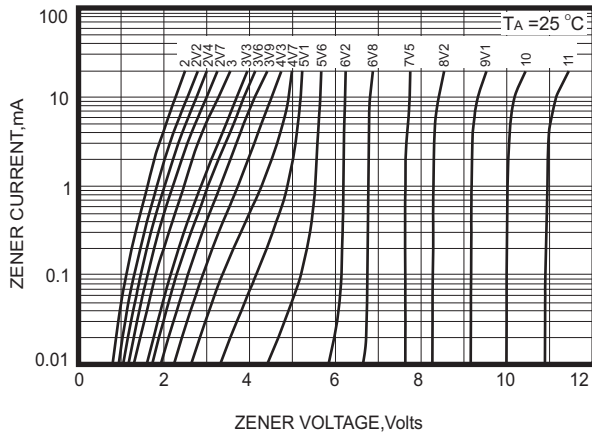

Fig.8 ZENER VOLTAGE VERSUS ZENER CURRENT

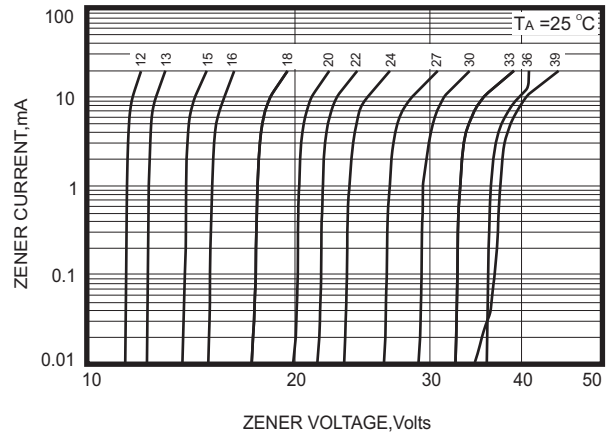
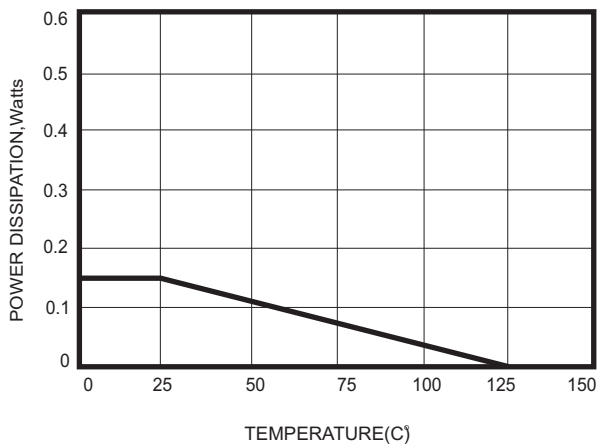
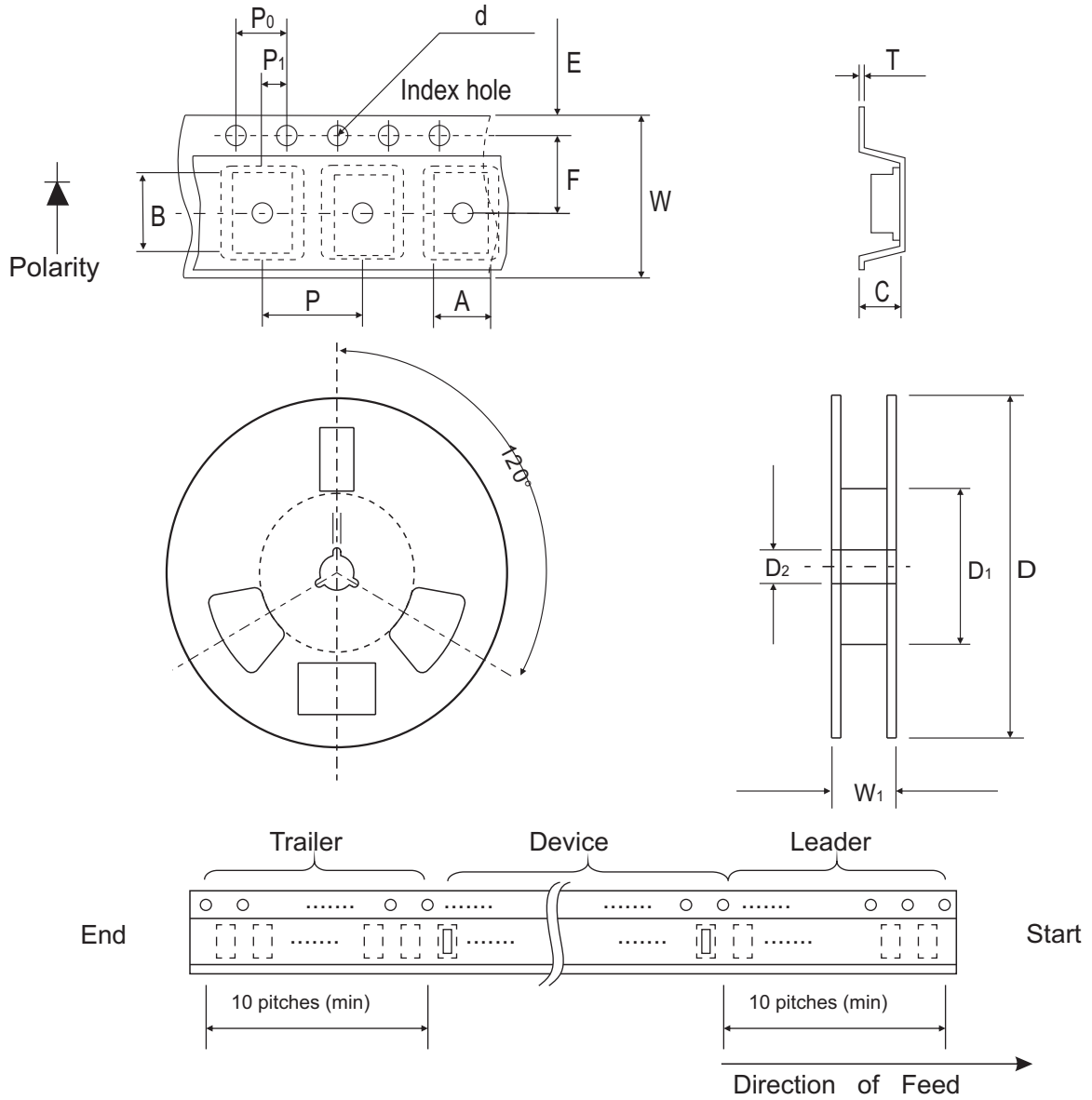

Fig.9 STEADY STATE POWER DERATING



Reel Taping Specification



0603 (SOD-523F)	SYMBOL	A	B	C	d	D	D ₁	D ₂
	(mm)	1.00 ± 0.10	1.85 ± 0.10	1.00 ± 0.10	1.55 ± 0.05	178 ± 1	60.0 MIN.	13.0 ± 0.20
	(inch)	0.039 ± 0.004	0.073 ± 0.004	0.039 ± 0.004	0.061 ± 0.002	7.008 ± 0.04	2.362 MIN.	0.512 ± 0.008

0603 (SOD-523F)	SYMBOL	E	F	P	P ₀	P ₁	T	W	W ₁
	(mm)	1.75 ± 0.10	3.50 ± 0.05	4.00 ± 0.10	4.00 ± 0.10	2.00 ± 0.05	0.23 ± 0.05	8.00 ± 0.20	13.5 MAX.
	(inch)	0.069 ± 0.004	0.138 ± 0.002	0.157 ± 0.004	0.157 ± 0.004	0.079 ± 0.004	0.009 ± 0.002	0.315 ± 0.008	0.531 MAX.

Suggested PAD Layout

SIZE	0603/SOD-523F	
	(mm)	(inch)
A	1.70	0.067
B	0.60	0.024
C	0.80	0.031
D	2.30	0.091
E	1.10	0.043

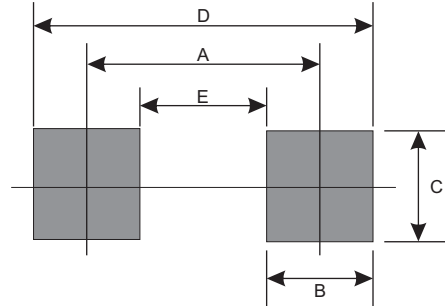

Standard Package

Case Type	Qty per Reel	Reel Size
	(Pcs)	(inch)
0603/SOD-523F	4000	7

Mouser Electronics

Authorized Distributor

Click to View Pricing, Inventory, Delivery & Lifecycle Information:

Comchip Technology:

[CZRU52C10-HF](#) [CZRU52C11-HF](#) [CZRU52C12-HF](#) [CZRU52C13-HF](#) [CZRU52C15-HF](#) [CZRU52C16-HF](#)
[CZRU52C18-HF](#) [CZRU52C20-HF](#) [CZRU52C22-HF](#) [CZRU52C24-HF](#) [CZRU52C27-HF](#) [CZRU52C2-HF](#)
[CZRU52C2V2-HF](#) [CZRU52C2V4-HF](#) [CZRU52C2V7-HF](#) [CZRU52C30-HF](#) [CZRU52C33-HF](#) [CZRU52C36-HF](#)
[CZRU52C39-HF](#) [CZRU52C3-HF](#) [CZRU52C3V3-HF](#) [CZRU52C3V6-HF](#) [CZRU52C3V9-HF](#) [CZRU52C4V3-HF](#)
[CZRU52C4V7-HF](#) [CZRU52C5V1-HF](#) [CZRU52C5V6-HF](#) [CZRU52C6V2-HF](#) [CZRU52C6V8-HF](#) [CZRU52C7V5-HF](#)
[CZRU52C8V2-HF](#) [CZRU52C9V1-HF](#) [CZRU52C2V7](#) [CZRU52C3](#) [CZRU52C3V3](#) [CZRU52C6V2](#) [CZRU52C22](#)
[CZRU52C39](#) [CZRU52C2V4](#) [CZRU52C8V2](#) [CZRU52C12](#) [CZRU52C33](#) [CZRU52C16](#) [CZRU52C24](#) [CZRU52C5V6](#)
[CZRU52C7V5](#) [CZRU52C3V9](#) [CZRU52C11](#) [CZRU52C27](#) [CZRU52C3V6](#) [CZRU52C36](#) [CZRU52C2](#) [CZRU52C9V1](#)
[CZRU52C13](#) [CZRU52C4V3](#) [CZRU52C30](#) [CZRU52C2V2](#) [CZRU52C15](#) [CZRU52C10](#) [CZRU52C20](#) [CZRU52C4V7](#)
[CZRU52C5V1](#) [CZRU52C6V8](#) [CZRU52C18](#)