

Table 3. ESD Protection Characteristics

Test Methodology	Class
Human Body Model (per JESD22-A114)	1B (Minimum)
Machine Model (per EIA/JESD22-A115)	A (Minimum)
Charge Device Model (per JESD22-C101)	IV (Minimum)

Table 4. Electrical Characteristics ($T_A = 25^\circ\text{C}$ unless otherwise noted)

Characteristic	Symbol	Min	Typ	Max	Unit
----------------	--------	-----	-----	-----	------

Off Characteristics

Zero Gate Voltage Drain Leakage Current ($V_{DS} = 65\text{ Vdc}$, $V_{GS} = 0\text{ Vdc}$)	I_{DSS}	—	—	10	μAdc
Zero Gate Voltage Drain Leakage Current ($V_{DS} = 28\text{ Vdc}$, $V_{GS} = 0\text{ Vdc}$)	I_{DSS}	—	—	1	μAdc
Gate-Source Leakage Current ($V_{GS} = 5\text{ Vdc}$, $V_{DS} = 0\text{ Vdc}$)	I_{GSS}	—	—	1	μAdc

On Characteristics

Gate Threshold Voltage ($V_{DS} = 10\text{ Vdc}$, $I_D = 348\ \mu\text{Adc}$)	$V_{GS(th)}$	1.2	2	2.7	Vdc
Gate Quiescent Voltage ($V_{DS} = 28\text{ Vdc}$, $I_D = 1500\text{ mAdc}$)	$V_{GS(Q)}$	—	2.7	—	Vdc
Fixture Gate Quiescent Voltage (1) ($V_{DD} = 28\text{ Vdc}$, $I_D = 1500\text{ mAdc}$, Measured in Functional Test)	$V_{GG(Q)}$	4	5.4	7	Vdc
Drain-Source On-Voltage ($V_{GS} = 10\text{ Vdc}$, $I_D = 3.4\text{ Adc}$)	$V_{DS(on)}$	0.1	0.24	0.3	Vdc

Dynamic Characteristics (2)

Reverse Transfer Capacitance ($V_{DS} = 28\text{ Vdc} \pm 30\text{ mV(rms)ac}$ @ 1 MHz, $V_{GS} = 0\text{ Vdc}$)	C_{rss}	—	10.4	—	pF
Output Capacitance ($V_{DS} = 28\text{ Vdc} \pm 30\text{ mV(rms)ac}$ @ 1 MHz, $V_{GS} = 0\text{ Vdc}$)	C_{oss}	—	711	—	pF
Input Capacitance ($V_{DS} = 28\text{ Vdc}$, $V_{GS} = 0\text{ Vdc} \pm 30\text{ mV(rms)ac}$ @ 1 MHz)	C_{iss}	—	326	—	pF

Functional Tests (In Freescale Test Fixture, 50 ohm system) $V_{DD} = 28\text{ Vdc}$, $I_{DQ} = 1500\text{ mA}$, $P_{out} = 23\text{ W Avg.}$, $f = 2700\text{ MHz}$, WiMAX Signal, 802.16d, 7 MHz Channel Bandwidth, 64 QAM $3/4$, 4 Bursts, PAR = 9.5 dB @ 0.01% Probability on CCDF. ACPR measured in 0.5 MHz Channel Bandwidth @ $\pm 5.25\text{ MHz}$ Offset.

Power Gain	G_{ps}	15	16.5	18.5	dB
Drain Efficiency	η_D	18	20	23	%
Output Peak-to-Average Ratio @ 0.01% Probability on CCDF	PAR	7.5	8.2	—	dB
Adjacent Channel Power Ratio	ACPR	—	-49	-46	dBc
Input Return Loss	IRL	—	-8	-5	dB

- $V_{GG} = 2 \times V_{GS(Q)}$. Parameter measured on Freescale Test Fixture, due to resistive divider network on the board. Refer to Test Circuit schematic.
- Part internally matched both on input and output.

(continued)

Table 4. Electrical Characteristics ($T_A = 25^\circ\text{C}$ unless otherwise noted) (continued)

Characteristic	Symbol	Min	Typ	Max	Unit
Typical Performances OFDM Signal (In Freescale Test Fixture, 50 ohm system) $V_{DD} = 28\text{ Vdc}$, $I_{DQ} = 1500\text{ mA}$, $P_{out} = 23\text{ W Avg.}$, $f = 2500\text{ MHz}$ and $f = 2700\text{ MHz}$, WiMAX Signal, OFDM Single-Carrier, 7 MHz Channel Bandwidth, 64 QAM $3/4$, 4 Bursts, PAR = 9.5 dB @ 0.01% Probability on CCDF.					
Mask System Type G @ $P_{out} = 23\text{ W Avg.}$ Point B at 3.5 MHz Offset Point C at 5 MHz Offset Point D at 7.4 MHz Offset Point E at 14 MHz Offset Point F at 17.5 MHz Offset	Mask	—	-27 -40 -44 -60 -60	—	dBc
Relative Constellation Error @ $P_{out} = 23\text{ W Avg.}$ (1)	RCE	—	-33	—	dB
Error Vector Magnitude (1) (Typical EVM Performance @ $P_{out} = 23\text{ W Avg.}$ with OFDM 802.16d Signal Call)	EVM	—	2.2	—	% rms

Typical Performances (In Freescale Test Fixture, 50 ohm system) $V_{DD} = 28\text{ Vdc}$, $I_{DQ} = 1500\text{ mA}$, 2500–2700 MHz Bandwidth

Video Bandwidth @ 105 W PEP P_{out} where $IM3 = -30\text{ dBc}$ (Tone Spacing from 100 kHz to VBW) $\Delta IMD3 = IMD3 @ \text{VBW frequency} - IMD3 @ 100\text{ kHz} < 1\text{ dBc}$ (both sidebands)	VBW	—	40	—	MHz
Gain Flatness in 200 MHz Bandwidth @ $P_{out} = 23\text{ W Avg.}$	G_F	—	1.2	—	dB
Average Deviation from Linear Phase in 200 MHz Bandwidth @ $P_{out} = 105\text{ W CW}$	Φ	—	135	—	°
Average Group Delay @ $P_{out} = 105\text{ W CW}$, $f = 2600\text{ MHz}$	Delay	—	1.5	—	ns
Part-to-Part Insertion Phase Variation @ $P_{out} = 105\text{ W CW}$, $f = 2600\text{ MHz}$, Six Sigma Window	$\Delta\Phi$	—	81.3	—	°
Gain Variation over Temperature (-30°C to $+85^\circ\text{C}$)	ΔG	—	0.013	—	dB/°C
Output Power Variation over Temperature (-30°C to $+85^\circ\text{C}$)	ΔP_{1dB}	—	0.01	—	dB/°C

1. $RCE = 20\text{Log}(EVM/100)$

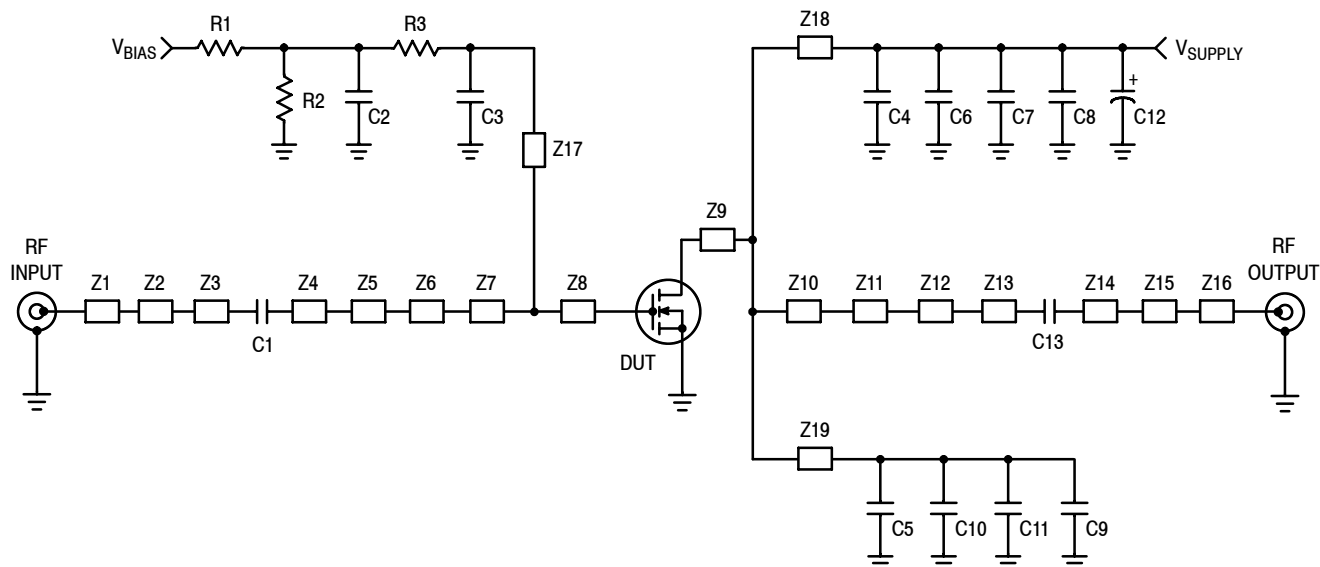

Z1	0.320" x 0.084" Microstrip	Z11	0.251" x 0.084" Microstrip
Z2	0.380" x 0.240" Microstrip	Z12	0.160" x 0.162" Microstrip
Z3	0.046" x 0.084" Microstrip	Z13	0.566" x 0.084" Microstrip
Z4	0.273" x 0.084" Microstrip	Z14	0.059" x 0.084" Microstrip
Z5	0.360" x 0.600" Microstrip	Z15	0.080" x 0.123" Microstrip
Z6	0.260" x 0.394" Microstrip	Z16	0.583" x 0.084" Microstrip
Z7	0.145" x 0.922" Microstrip	Z17*	0.950" x 0.100" Microstrip
Z8	0.455" x 0.922" Microstrip	Z18, Z19*	0.560" x 0.100" Microstrip
Z9	0.106" x 0.716" Microstrip	PCB	Taconic TLX8-0300, 0.030", $\epsilon_r = 2.55$
Z10	0.413" x 0.716" Microstrip		

* Variable for tuning

Figure 1. MRF7S27130HR3(HSR3) Test Circuit Schematic

Table 5. MRF7S27130HR3(HSR3) Test Circuit Component Designations and Values

Part	Description	Part Number	Manufacturer
C1	2 pF Chip Capacitor	ATC100B2R0BT500XT	ATC
C2, C6, C7, C8, C9, C10, C11	10 μ F, 50 V Chip Capacitors	C5750X5R1H106M	TDK
C3	3 pF Chip Capacitor	ATC100B3R0BT500XT	ATC
C4, C5	3.6 pF Chip Capacitors	ATC100B3R6BT500XT	ATC
C12	470 μ F, 63 V Electrolytic Capacitor, Radial	EKME630ELL471MK255	Multicomp
C13	5.6 pF Chip Capacitor	ATC100B5R6BT500XT	ATC
R1, R2	2 K Ω , 1/4 W Chip Resistors	CRCW12062001FKEA	Vishay
R3	10 Ω , 1/4 W Chip Resistor	CRCW120610R1FKEA	Vishay

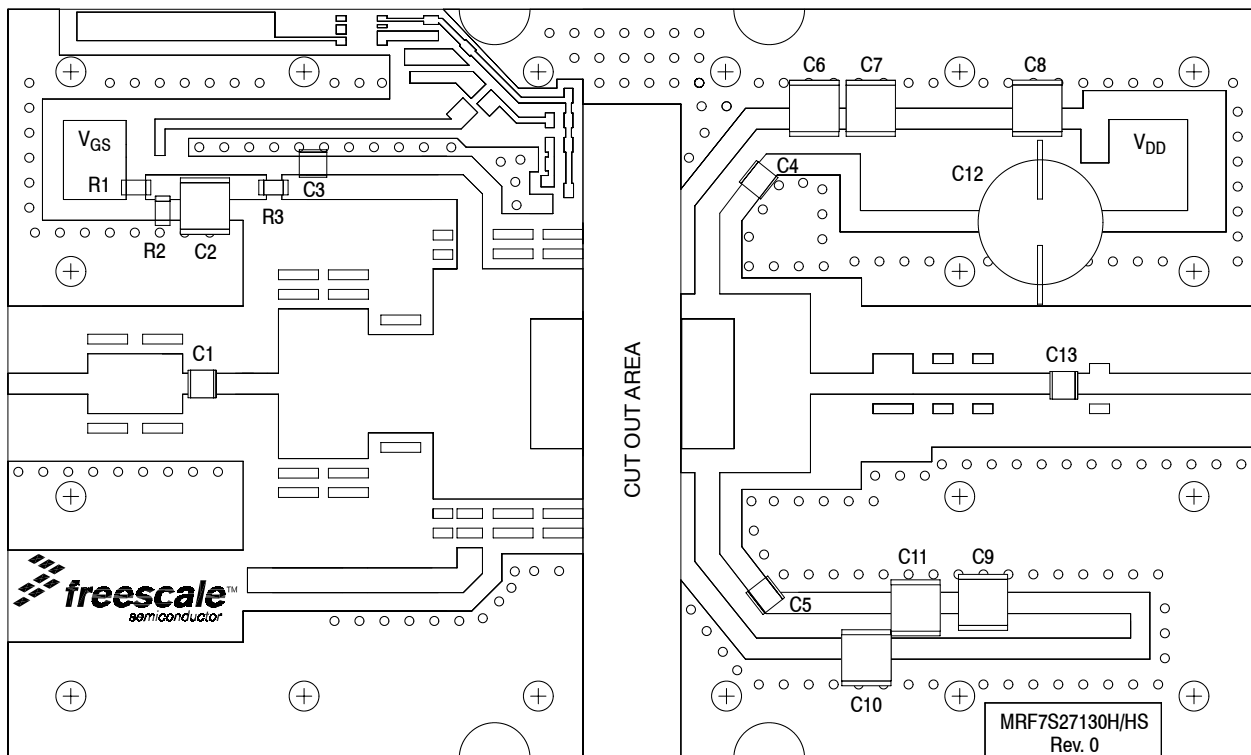

Figure 2. MRF7S27130HR3(HSR3) Test Circuit Component Layout

TYPICAL CHARACTERISTICS

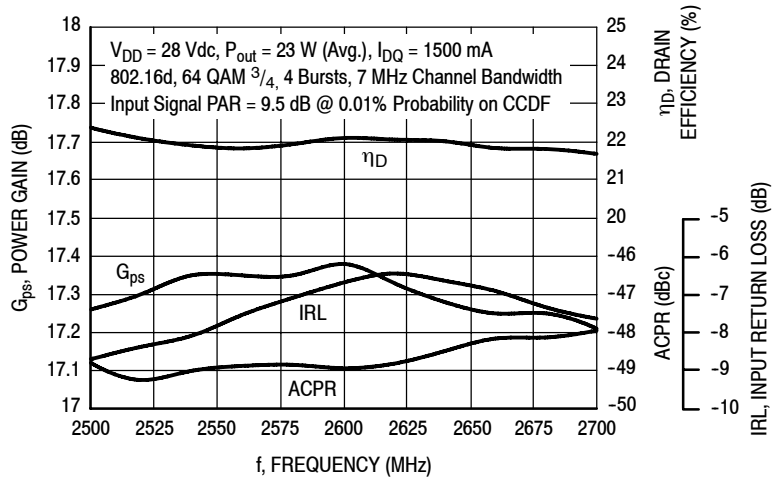

Figure 3. WiMAX Broadband Performance @ $P_{out} = 23 \text{ Watts Avg.}$

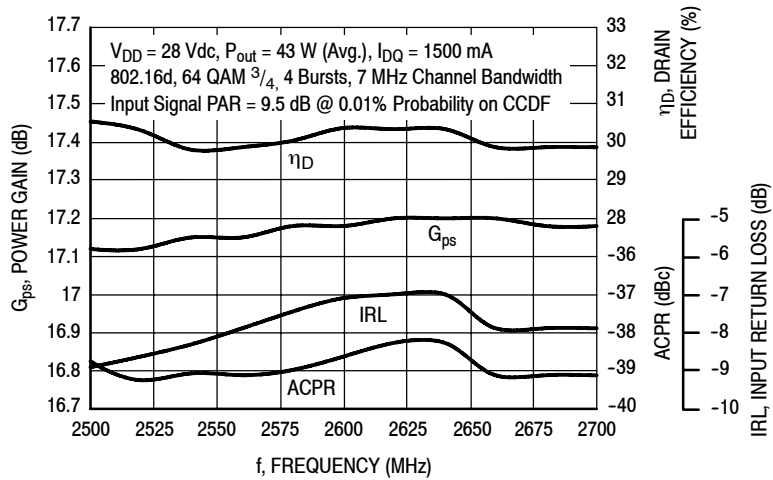

Figure 4. WiMAX Broadband Performance @ $P_{out} = 43 \text{ Watts Avg.}$

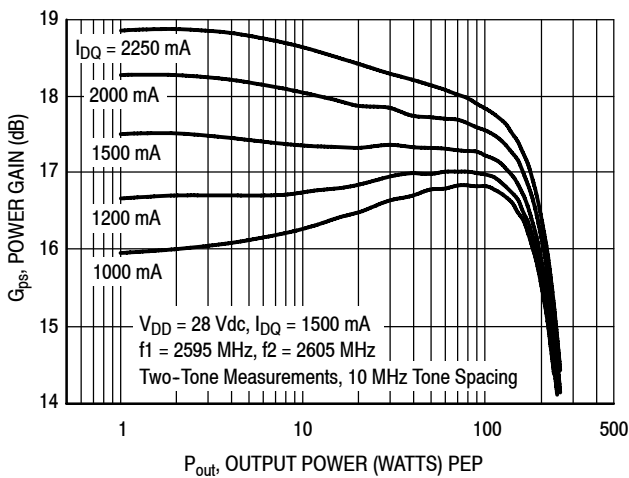

Figure 5. Two-Tone Power Gain versus Output Power

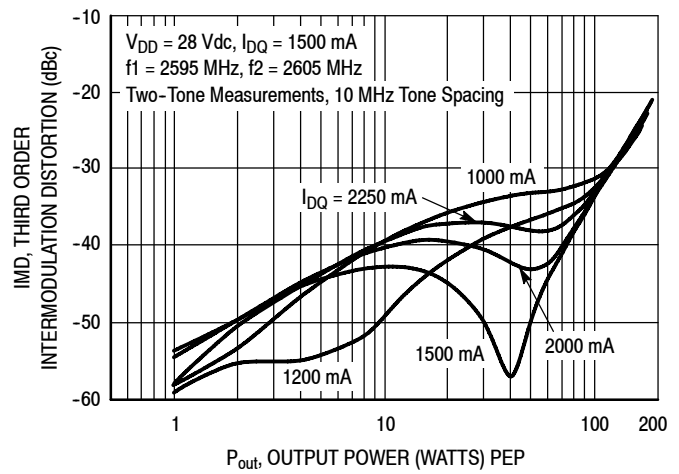

Figure 6. Third Order Intermodulation Distortion versus Output Power

TYPICAL CHARACTERISTICS

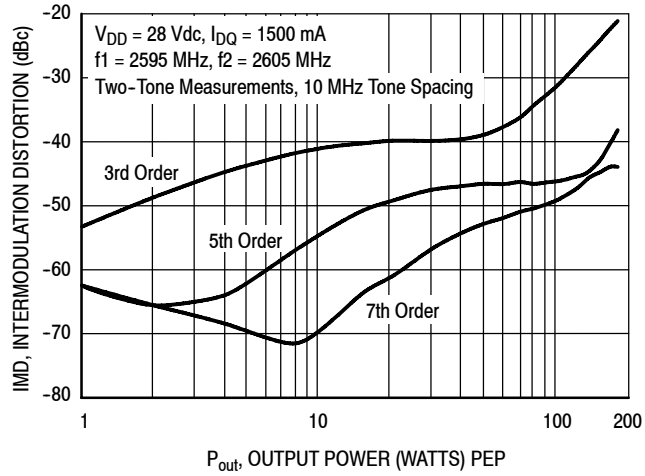

Figure 7. Intermodulation Distortion Products versus Output Power

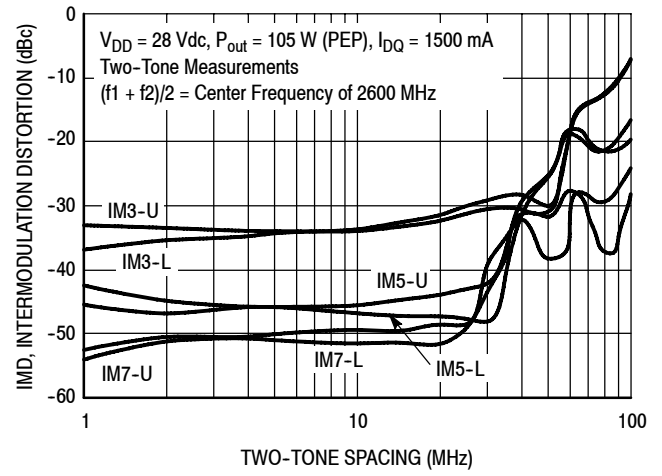

Figure 8. Intermodulation Distortion Products versus Tone Spacing

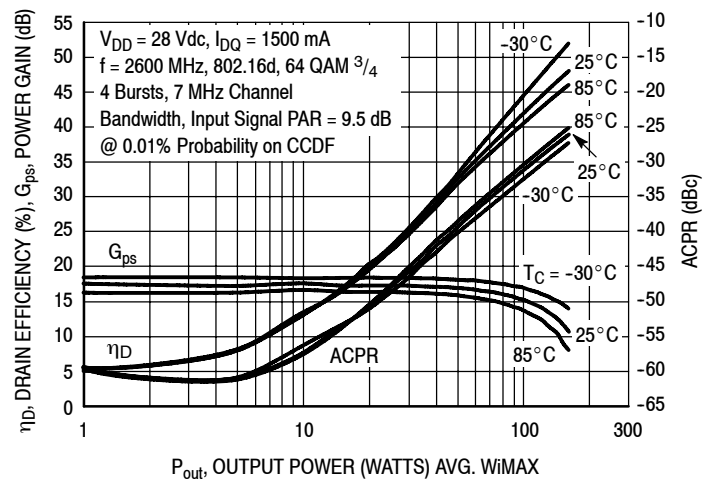

Figure 9. WiMAX, ACPR, Power Gain and Drain Efficiency versus Output Power

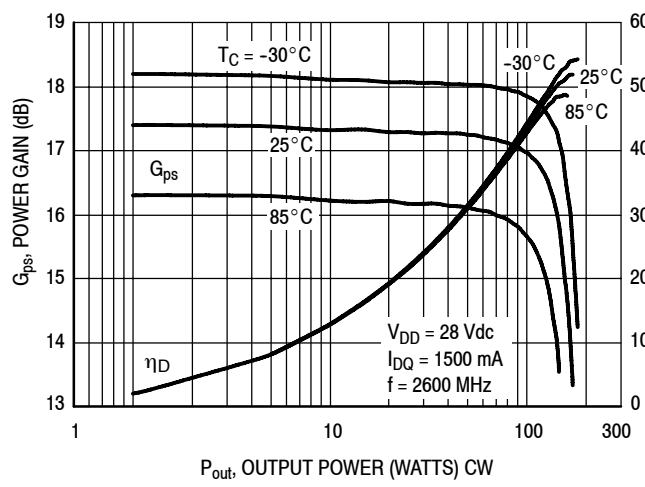

Figure 10. Power Gain and Drain Efficiency versus CW Output Power

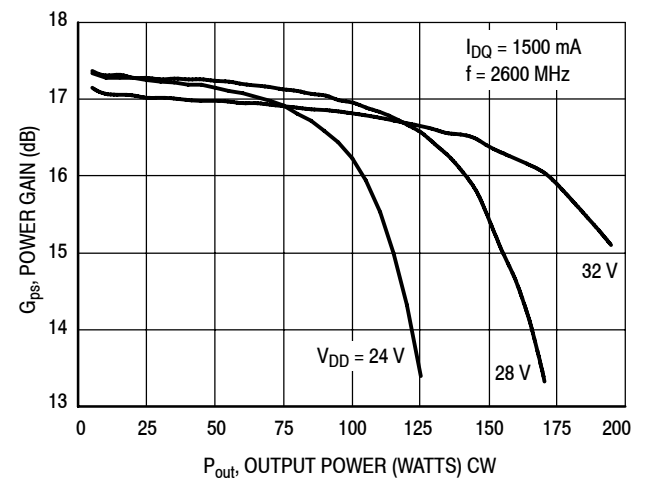

Figure 11. Power Gain versus Output Power

WiMAX TEST SIGNAL

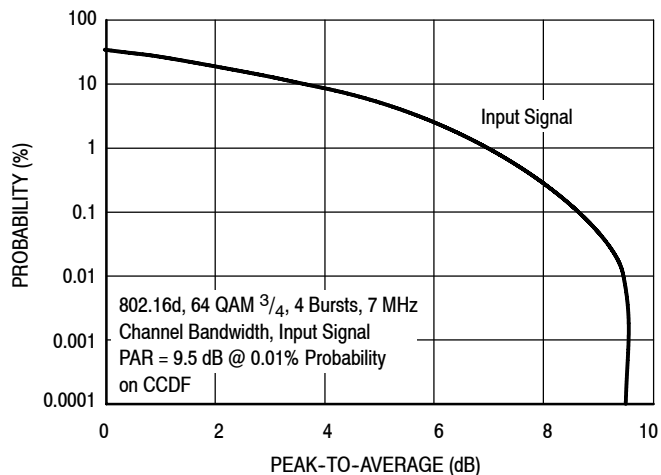

Figure 12. OFDM 802.16d Test Signal

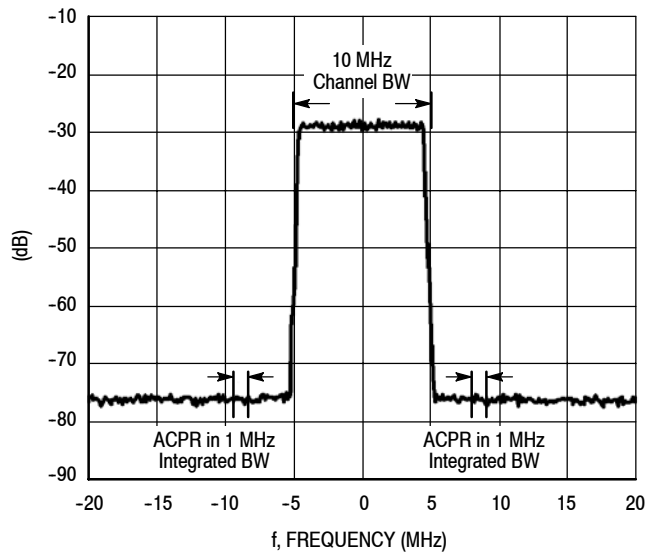
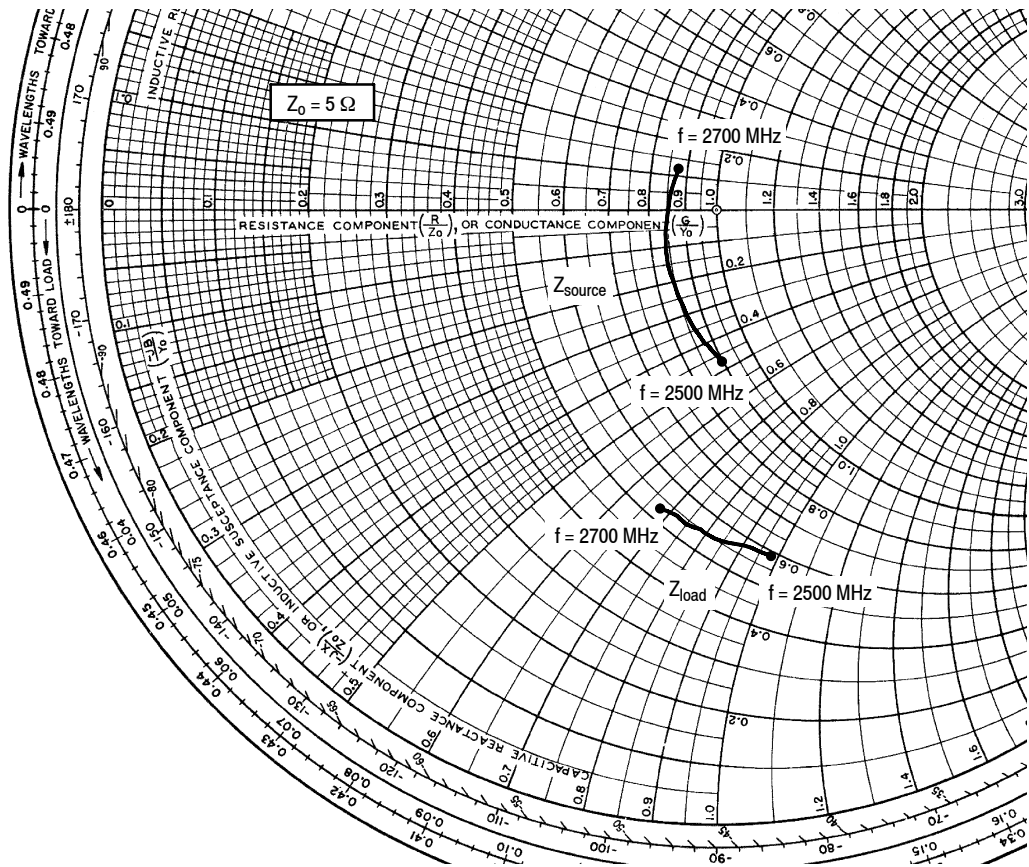

Figure 13. WiMAX Spectrum Mask Specifications



$V_{DD} = 28 \text{ Vdc}$, $I_{DQ} = 1500 \text{ mA}$, $P_{out} = 23 \text{ W Avg.}$

f MHz	Z_{source} Ω	Z_{load} Ω
2500	4.499 - j2.335	2.936 - j4.876
2525	4.382 - j1.944	2.885 - j4.666
2550	4.294 - j1.567	2.838 - j4.467
2575	4.234 - j1.194	2.797 - j4.273
2600	4.209 - j0.820	2.763 - j4.084
2625	4.219 - j0.447	2.733 - j3.903
2650	4.248 - j0.090	2.706 - j3.732
2675	4.304 + j0.261	2.678 - j3.570
2700	4.390 + j0.612	2.652 - j3.410

Z_{source} = Test circuit impedance as measured from gate to ground.

Z_{load} = Test circuit impedance as measured from drain to ground.

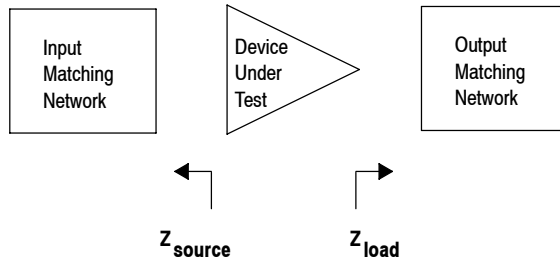
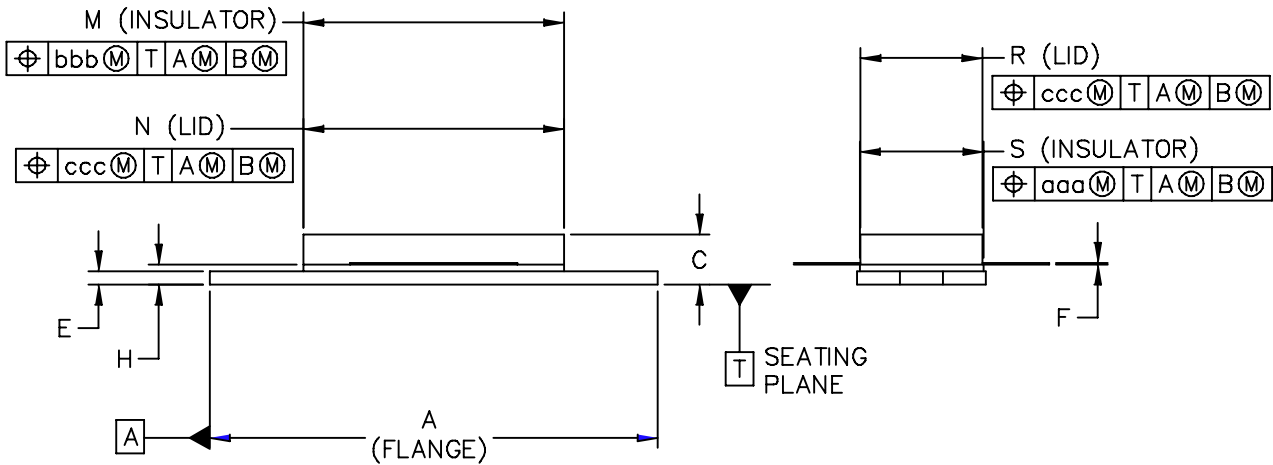
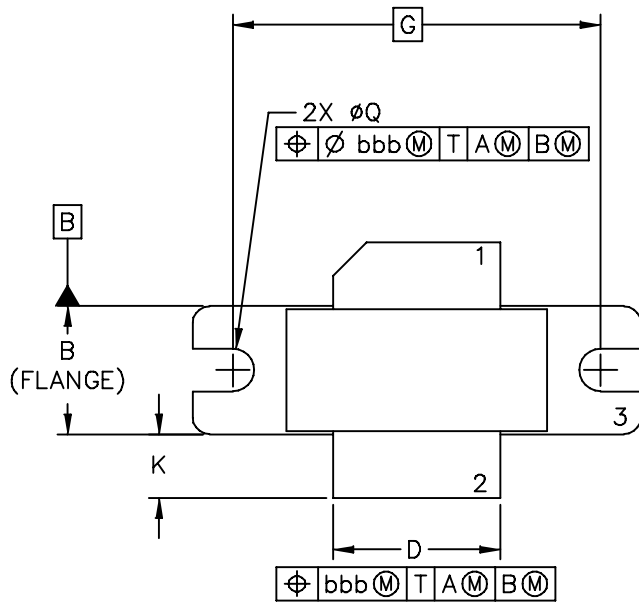

Figure 14. Series Equivalent Source and Load Impedance

PACKAGE DIMENSIONS



© FREESCALE SEMICONDUCTOR, INC. ALL RIGHTS RESERVED.		MECHANICAL OUTLINE	PRINT VERSION NOT TO SCALE
TITLE: NI-780	DOCUMENT NO: 98ASB15607C		REV: G
	CASE NUMBER: 465-06		31 MAR 2005
	STANDARD: NON-JEDEC		

NOTES:

1. DIMENSIONING AND TOLERANCING PER ANSI Y14.5M-1994.
2. CONTROLLING DIMENSION: INCH.
3. DELETED
4. DIMENSION H IS MEASURED .030 (.762) AWAY FROM PACKAGE BODY.

STYLE 1:

- PIN 1. DRAIN
 2. GATE
 3. SOURCE

DIM	INCH		MILLIMETER		DIM	INCH		MILLIMETER	
	MIN	MAX	MIN	MAX		MIN	MAX	MIN	MAX
A	1.335	1.345	33.91	34.16	R	.365	.375	9.27	9.53
B	.380	.390	9.65	9.91	S	.365	.375	9.27	9.52
C	.125	.170	3.18	4.32	aaa	—	.005	—	0.127
D	.495	.505	12.57	12.83	bbb	—	.010	—	0.254
E	.035	.045	0.89	1.14	ccc	—	.015	—	0.381
F	.003	.006	0.08	0.15	—	—	—	—	—
G	1.100 BSC		27.94 BSC		—	—	—	—	—
H	.057	.067	1.45	1.7	—	—	—	—	—
K	.170	.210	4.32	5.33	—	—	—	—	—
M	.774	.786	19.66	19.96	—	—	—	—	—
N	.772	.788	19.6	20	—	—	—	—	—
Q	∅.118	∅.138	∅3	∅3.51	—	—	—	—	—
© FREESCALE SEMICONDUCTOR, INC. ALL RIGHTS RESERVED.			MECHANICAL OUTLINE			PRINT VERSION NOT TO SCALE			
TITLE: NI-780					DOCUMENT NO: 98ASB15607C			REV: G	
					CASE NUMBER: 465-06			31 MAR 2005	
					STANDARD: NON-JEDEC				

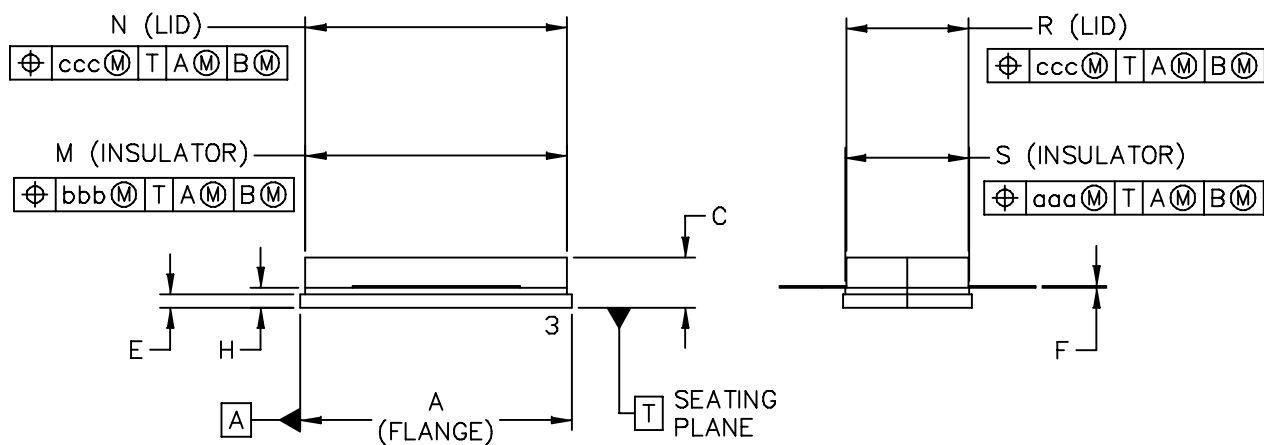
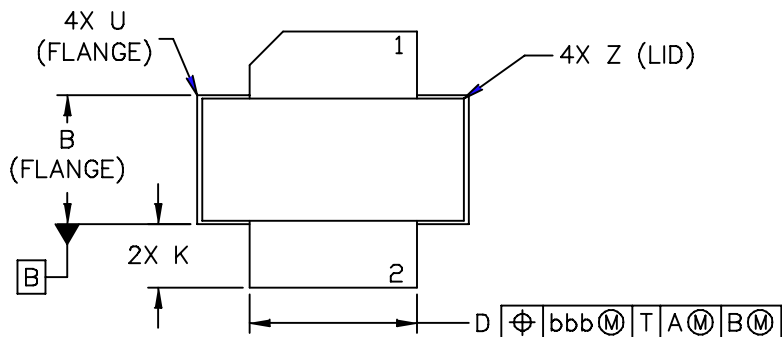

© FREESCALE SEMICONDUCTOR, INC. ALL RIGHTS RESERVED.	MECHANICAL OUTLINE	PRINT VERSION NOT TO SCALE	
TITLE: NI-780S	DOCUMENT NO: 98ASB16718C	REV: H	
	CASE NUMBER: 465A-06	31 MAR 2005	
	STANDARD: NON-JEDEC		

NOTES:

1. DIMENSIONING AND TOLERANCING PER ANSI Y14.5M-1994.
2. CONTROLLING DIMENSION: INCH.
3. DELETED
4. DIMENSION H IS MEASURED .030 (0.762) AWAY FROM PACKAGE BODY.

STYLE 1:

- PIN 1. DRAIN
2. GATE
3. SOURCE

DIM	INCH		MILLIMETER		DIM	INCH		MILLIMETER	
	MIN	MAX	MIN	MAX		MIN	MAX	MIN	MAX
A	.805	-.815	20.45	20.7	U	-.040	-	-	1.02
B	.380	-.390	9.65	9.91	Z	-.030	-	-	0.76
C	.125	-.170	3.18	4.32	aaa	-.005	-	-	0.127
D	.495	-.505	12.57	12.83	bbb	-.010	-	-	0.254
E	.035	-.045	0.89	1.14	ccc	-.015	-	-	0.381
F	.003	-.006	0.08	0.15	-	-	-	-	-
H	.057	-.067	1.45	1.7	-	-	-	-	-
K	.170	-.210	4.32	5.33	-	-	-	-	-
M	.774	-.786	19.61	20.02	-	-	-	-	-
N	.772	-.788	19.61	20.02	-	-	-	-	-
R	.365	-.375	9.27	9.53	-	-	-	-	-
S	.365	-.375	9.27	9.52	-	-	-	-	-

© FREESCALE SEMICONDUCTOR, INC. ALL RIGHTS RESERVED.		MECHANICAL OUTLINE		PRINT VERSION NOT TO SCALE	
TITLE: NI-780S		DOCUMENT NO: 98ASB16718C		REV: H	
		CASE NUMBER: 465A-06		31 MAR 2005	
		STANDARD: NON-JEDEC			

PRODUCT DOCUMENTATION AND SOFTWARE

Refer to the following documents and software to aid your design process.

Application Notes

- AN1955: Thermal Measurement Methodology of RF Power Amplifiers

Engineering Bulletins

- EB212: Using Data Sheet Impedances for RF LDMOS Devices

Software

- Electromigration MTTF Calculator
- RF High Power Model

For Software, do a Part Number search at <http://www.freescale.com>, and select the "Part Number" link. Go to the Software & Tools tab on the part's Product Summary page to download the respective tool.

R5 TAPE AND REEL OPTION

R5 Suffix = 50 Units, 56 mm Tape Width, 13 inch Reel.

The R5 tape and reel option for MRF7S27130H and MRF7S27130HS parts will be available for 2 years after release of MRF7S27130H and MRF7S27130HS. Freescale Semiconductor, Inc. reserves the right to limit the quantities that will be delivered in the R5 tape and reel option. At the end of the 2 year period customers who have purchased these devices in the R5 tape and reel option will be offered MRF7S27130H and MRF7S27130HS in the R3 tape and reel option.

REVISION HISTORY

The following table summarizes revisions to this document.

Revision	Date	Description
0	Sept. 2007	<ul style="list-style-type: none"> • Initial Release of Data Sheet
1	Dec. 2008	<ul style="list-style-type: none"> • Modified Fig. 13 to display Input Signal only, p. 8 • Updated Fig. 14, WiMAX Spectrum Mask Specification, to reflect the distortion free input test signal versus the distortion loaded output signal, p. 8
2	Mar. 2011	<ul style="list-style-type: none"> • Modified data sheet to reflect RF Test Reduction described in Product and Process Change Notification number, PCN13628, p. 1, 2 • Fig. 12, MTTF versus Junction Temperature removed, p. 8. Refer to the device's MTTF Calculator available at freescale.com/RFpower. Go to Design Resources > Software and Tools. • Added Electromigration MTTF Calculator and RF High Power Model availability to Product Software, p. 14

How to Reach Us:

Home Page:

www.freescale.com

Web Support:

<http://www.freescale.com/support>

USA/Europe or Locations Not Listed:

Freescale Semiconductor, Inc.
Technical Information Center, EL516
2100 East Elliot Road
Tempe, Arizona 85284
1-800-521-6274 or +1-480-768-2130
www.freescale.com/support

Europe, Middle East, and Africa:

Freescale Halbleiter Deutschland GmbH
Technical Information Center
Schatzbogen 7
81829 Muenchen, Germany
+44 1296 380 456 (English)
+46 8 52200080 (English)
+49 89 92103 559 (German)
+33 1 69 35 48 48 (French)
www.freescale.com/support

Japan:

Freescale Semiconductor Japan Ltd.
Headquarters
ARCO Tower 15F
1-8-1, Shimo-Meguro, Meguro-ku,
Tokyo 153-0064
Japan
0120 191014 or +81 3 5437 9125
support.japan@freescale.com

Asia/Pacific:

Freescale Semiconductor China Ltd.
Exchange Building 23F
No. 118 Jianguo Road
Chaoyang District
Beijing 100022
China
+86 10 5879 8000
support.asia@freescale.com

For Literature Requests Only:

Freescale Semiconductor Literature Distribution Center
1-800-441-2447 or +1-303-675-2140
Fax: +1-303-675-2150
LDCForFreescaleSemiconductor@hibbertgroup.com

Information in this document is provided solely to enable system and software implementers to use Freescale Semiconductor products. There are no express or implied copyright licenses granted hereunder to design or fabricate any integrated circuits or integrated circuits based on the information in this document.

Freescale Semiconductor reserves the right to make changes without further notice to any products herein. Freescale Semiconductor makes no warranty, representation or guarantee regarding the suitability of its products for any particular purpose, nor does Freescale Semiconductor assume any liability arising out of the application or use of any product or circuit, and specifically disclaims any and all liability, including without limitation consequential or incidental damages. "Typical" parameters that may be provided in Freescale Semiconductor data sheets and/or specifications can and do vary in different applications and actual performance may vary over time. All operating parameters, including "Typicals", must be validated for each customer application by customer's technical experts. Freescale Semiconductor does not convey any license under its patent rights nor the rights of others. Freescale Semiconductor products are not designed, intended, or authorized for use as components in systems intended for surgical implant into the body, or other applications intended to support or sustain life, or for any other application in which the failure of the Freescale Semiconductor product could create a situation where personal injury or death may occur. Should Buyer purchase or use Freescale Semiconductor products for any such unintended or unauthorized application, Buyer shall indemnify and hold Freescale Semiconductor and its officers, employees, subsidiaries, affiliates, and distributors harmless against all claims, costs, damages, and expenses, and reasonable attorney fees arising out of, directly or indirectly, any claim of personal injury or death associated with such unintended or unauthorized use, even if such claim alleges that Freescale Semiconductor was negligent regarding the design or manufacture of the part.

Freescale™ and the Freescale logo are trademarks of Freescale Semiconductor, Inc. All other product or service names are the property of their respective owners.

© Freescale Semiconductor, Inc. 2007-2008, 2011. All rights reserved.

Mouser Electronics

Authorized Distributor

Click to View Pricing, Inventory, Delivery & Lifecycle Information:

[NXP:](#)

[MRF7S27130HSR3](#)