

# ADT7485A

## Temperature Sensor and Voltage Monitor with Simple Serial Transport

The ADT7485A is a digital temperature sensor and voltage monitor for use in PC applications with Simple Serial Transport (SST) interface. It can monitor its own temperature as well as the temperature of a remote sensor diode. It can also monitor four external voltage channels and its own supply voltage. The ADT7485A is controlled by a single SST bidirectional data line. This device is a fixed-address SST client where the target address is chosen by the state of the address pin, ADD.

### Features

- 1 On-Chip Temperature Sensor
- 1 Remote Temperature Sensor
- Monitors Up to 5.0 Voltages
- SST Interface
- This Device is Pb-Free, Halogen Free and is RoHS Compliant

### Applications

- Personal Computers
- Portable Personal Devices
- Industrial Sensor Nets

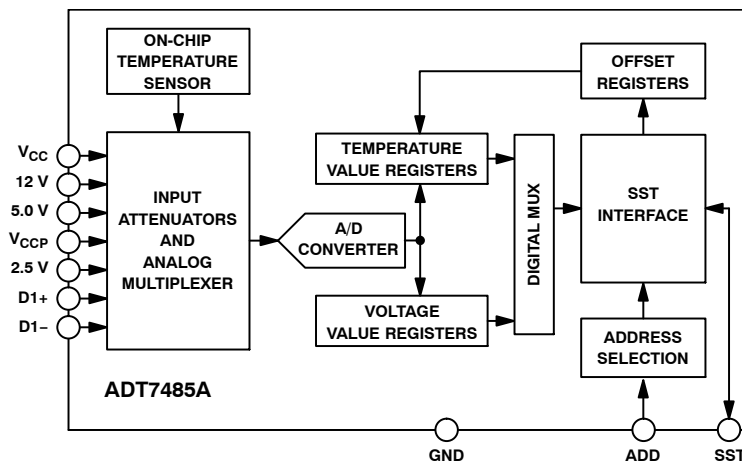
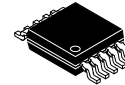

Figure 1. Functional Block Diagram



ON Semiconductor®

<http://onsemi.com>



MSOP-10  
CASE 846AC

### PIN ASSIGNMENT

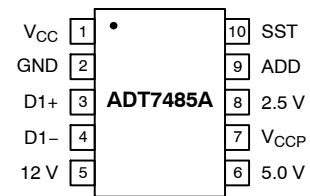

(Top View)

### MARKING DIAGRAM

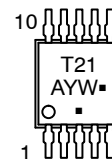

T21 = Specific Device Code  
A = Assembly Location  
Y = Year  
W = Work Week  
▪ = Pb-Free Package

(Note: Microdot may be in either location)

### ORDERING INFORMATION

See detailed ordering and shipping information in the package dimensions section on page 11 of this data sheet.

# ADT7485A

**Table 1. PIN ASSIGNMENT**

Pin No.	Mnemonic	Type	Description
1	V <sub>CC</sub>	Power Supply	3.3 V ±10%. V <sub>CC</sub> is also Monitored through this Pin
2	GND	Ground	Ground Pin
3	D1+	Analog Input	Positive Connection to Remote 1 Temperature Sensor
4	D1-	Analog Input	Negative Connection to Remote 1 Temperature Sensor
5	12 V	Analog Input	12 V Supply Monitor
6	5.0 V	Analog Input	5.0 V Supply Monitor
7	V <sub>CCP</sub>	Analog Input	Processor Core Voltage Monitor
8	2.5 V	Analog Input	2.5 V Supply Monitor
9	ADD	Digital Input	SST Address Select
10	SST	Digital Input/Output	SST Bidirectional Data Line

**Table 2. ABSOLUTE MAXIMUM RATINGS**

Parameter	Rating	Unit
Supply Voltage (V <sub>CC</sub> )	4.0	V
Voltage on 12 V Pin	16	V
Voltage on 5.0 V Pin	7.0	V
Voltage on 2.5 V and V <sub>CCP</sub> Pins	3.6	V
Voltage on Any Other Pin (Including SST Pin)	-0.3 to +3.6	V
Input Current at Any Pin	±5.0	mA
Package Input Current	±20	mA
Maximum Junction Temperature (T <sub>J MAX</sub> )	150	°C
Storage Temperature Range	-65 to +150	°C
Lead Temperature, Soldering		°C
IR Peak Re-flow Temperature	260	
Lead Temperature (10 sec)	300	
ESD Rating	1,500	V

Stresses exceeding Maximum Ratings may damage the device. Maximum Ratings are stress ratings only. Functional operation above the Recommended Operating Conditions is not implied. Extended exposure to stresses above the Recommended Operating Conditions may affect device reliability.

NOTE: This device is ESD sensitive. Use standard ESD precautions when handling.

**Table 3. THERMAL CHARACTERISTICS** (Note 1)

Package Type	θ <sub>JA</sub>	θ <sub>JC</sub>	Unit
10-lead MSOP	206	44	°C/W

1. θ<sub>JA</sub> is specified for the worst-case conditions, that is, a device soldered in a circuit board for surface-mount packages.

# ADT7485A

**Table 4. ELECTRICAL CHARACTERISTICS**

( $T_A = T_{MIN}$  to  $T_{MAX}$ ,  $V_{CC} = V_{MIN}$  to  $V_{MAX}$ , unless otherwise noted)

Parameter	Test Conditions/Comments	Min	Typ	Max	Unit
<b>Power Supply</b>					
Supply Voltage, $V_{CC}$		3.0	3.3	3.6	V
Undervoltage Lockout Threshold		-	2.8	-	V
Average Operating Supply Current, $I_{DD}$	Continuous Conversions	-	3.8	5.0	mA
<b>Temperature-to-Digital Converter</b>					
Local Sensor Accuracy	$40^{\circ}\text{C} \leq T_A \leq 70^{\circ}\text{C}$ ; $V_{CC} = 3.3\text{ V} \pm 5\%$ $-40^{\circ}\text{C} \leq T_A \leq +100^{\circ}\text{C}$	-	+1.0	$\pm 1.75$ $\pm 4.0$	$^{\circ}\text{C}$
Remote Sensor Accuracy	$-40^{\circ}\text{C} \leq T_D \leq +125^{\circ}\text{C}$ ; $T_A = 25^{\circ}\text{C}$ ; $V_{CC} = 3.3\text{ V}$ $-40^{\circ}\text{C} \leq T_D \leq +125^{\circ}\text{C}$ ; $-40 \leq T_A \leq 70^{\circ}\text{C}$ ; $V_{CC} = 3.3\text{ V} \pm 5\%$ $-40^{\circ}\text{C} \leq T_D \leq +125^{\circ}\text{C}$ ; $-40 \leq T_A \leq +100^{\circ}\text{C}$	-	+1.0	$\pm 1.0$ $\pm 1.75$ $\pm 4.0$	$^{\circ}\text{C}$
Remote Sensor Source Current	Low Level Mid Level High Level	- - -	12 80 204	- - -	$\mu\text{A}$
Resolution		-	0.016	-	$^{\circ}\text{C}$
Series Resistance Cancellation	The ADT7485A Cancels 1.5 k $\Omega$ in Series with the Remote Thermal Diode	-	1.5	-	k $\Omega$
<b>Digital Input (ADD)</b>					
Input High Voltage, $V_{IH}$		2.3	-	-	V
Input Low Voltage, $V_{IL}$		-	-	0.8	V
Input High Current, $I_{IH}$	$V_{IN} = V_{CC}$	-1.0	-	-	$\mu\text{A}$
Input Low Current, $I_{IL}$	$V_{IN} = 0$	-	-	1.0	$\mu\text{A}$
Pin Capacitance		-	5.0	-	pF
<b>Analogue-to-Digital Converter (Including Multiplexer and Attenuators)</b>					
Total Unadjusted Error (TUE)	12 V and 5.0 V Channels For All Other Channels	- -	- -	$\pm 2.0$ $\pm 1.5$	%
Differential Non-linearity (DNL)	10 Bits	-	-	$\pm 1.0$	LSB
Power Supply Sensitivity		-	$\pm 0.1$	-	%/V
Conversion Time (Voltage Input) (Note 1)	Averaging Enabled	-	-	11	ms
Conversion Time (Local Temperature) (Note 1)	Averaging Enabled	-	-	12	ms
Conversion Time (Remote Temperature) (Note 1)	Averaging Enabled	-	-	38	ms
Total Monitoring Cycle Time (Note 1)	Averaging Enabled	-	145	-	ms
Input Resistances $V_{CCP}$ and 2.5 V Channels 5.0 V Channel 12 V Channel		80 95 180	110 120 230	140 150 280	k $\Omega$

# ADT7485A

**Table 4. ELECTRICAL CHARACTERISTICS** (continued)  
 ( $T_A = T_{MIN}$  to  $T_{MAX}$ ,  $V_{CC} = V_{MIN}$  to  $V_{MAX}$ , unless otherwise noted)

Parameter	Test Conditions/Comments	Min	Typ	Max	Unit
<b>Digital I/O (SST Pin)</b>					
Input High Voltage, $V_{IH}$		1.1	–	–	V
Input Low Voltage, $V_{IL}$		–	–	0.4	V
Hysteresis (Note 1)	Between Input Switching Levels	–	150	–	mV
Output High Voltage, $V_{OH}$	$I_{SOURCE} = 6$ mA (maximum)	1.1	–	1.9	V
High Impedance State Leakage, $I_{LEAK}$	Device Powered On SST Bus; $V_{SST} = 1.1$ V, $V_{CC} = 3.3$ V	–	–	$\pm 1.0$	$\mu$ A
High Impedance State Leakage, $I_{LEAK}$	Device Non-powered On SST Bus; $V_{SST} = 1.1$ V, $V_{CC} = 0$ V	–	–	$\pm 10$	$\mu$ A
Signal Noise Immunity, $V_{NOISE}$	Noise Glitches from 10 MHz to 100 MHz; Width Up to 50 ns	300	–	–	mV p-p

### SST Timing

Bitwise Period, $t_{BIT}$		0.495	–	500	$\mu$ s
High Level Time for Logic 1, $t_{H1}$ (Note 2)	$t_{BIT}$ Defined in Speed Negotiation	$0.6 \times t_{BIT}$	$0.75 \times t_{BIT}$	$0.8 \times t_{BIT}$	$\mu$ s
High Level Time for Logic 0, $t_{H0}$ (Note 2)		$0.2 \times t_{BIT}$	$0.25 \times t_{BIT}$	$0.4 \times t_{BIT}$	$\mu$ s
Time to Assert SST High for Logic 1, $t_{SU, HIGH}$		–	–	$0.2 \times t_{BIT}$	$\mu$ s
Hold Time, $t_{HOLD}$ (Note 3)	See SST Specification Rev 1.0	–	–	$0.5 \times t_{BIT-M}$	$\mu$ s
Stop Time, $t_{STOP}$	Device Responding to a Constant Low Level Driven by Originator	$1.25 \times t_{BIT}$	$2 \times t_{BIT}$	$2 \times t_{BIT}$	$\mu$ s
Time to Respond After a Reset, $t_{RESET}$		–	–	0.4	ms
Response Time to Speed Negotiation After Powerup	Time after Powerup when Device Can Participate in Speed Negotiation	–	500	–	$\mu$ s

1. Guaranteed by design, not production tested.
2. Minimum and maximum bit times are relative to  $t_{BIT}$  defined in the timing negotiation pulse.
3. Device is compatible with hold time specification as driven by SST originator.

TYPICAL PERFORMANCE CHARACTERISTICS

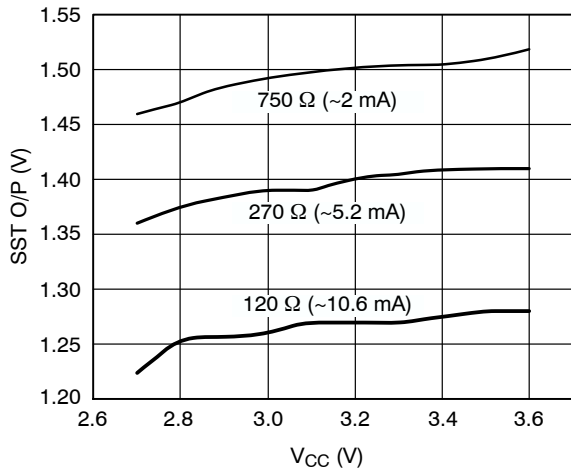

Figure 2. SST O/P Level vs. Supply Voltage

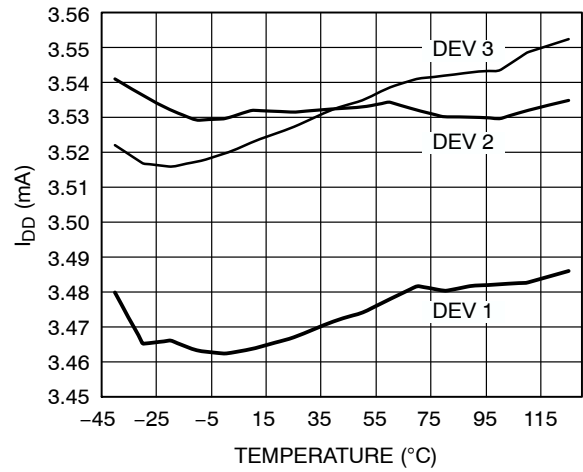

Figure 3. Supply Current vs. Temperature

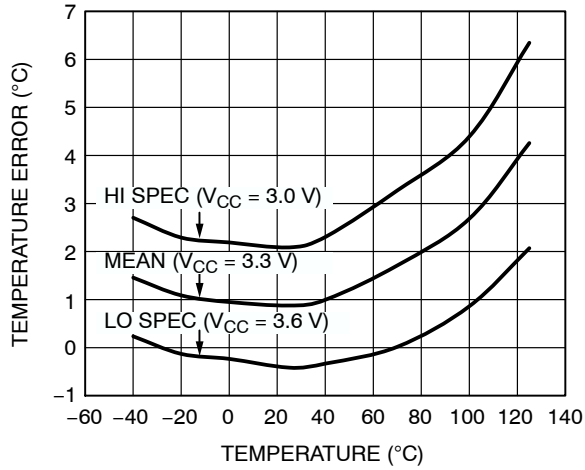

Figure 4. Local Temperature Error

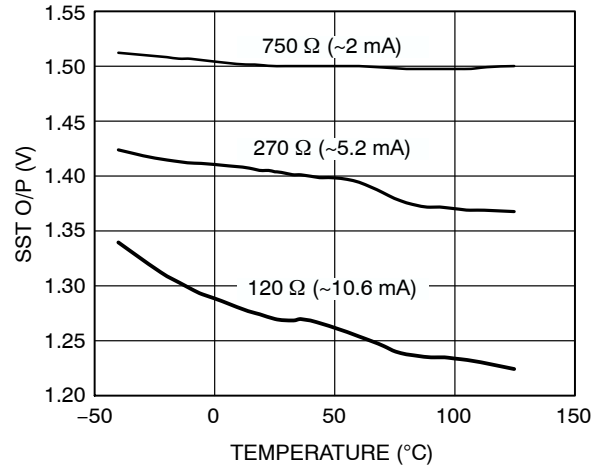

Figure 5. SST O/P Level vs. Temperature

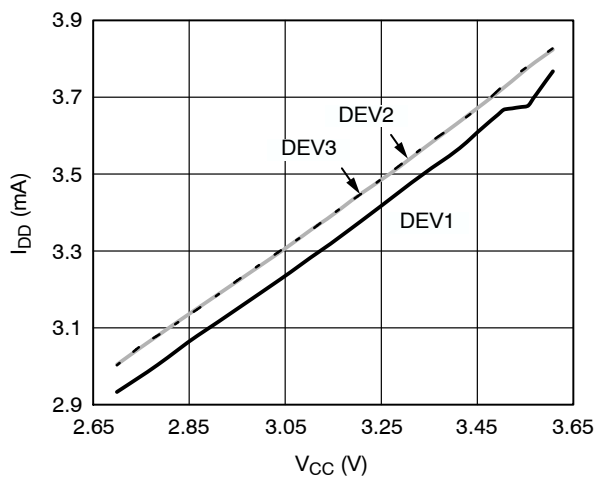

Figure 6. Supply Current vs. Voltage

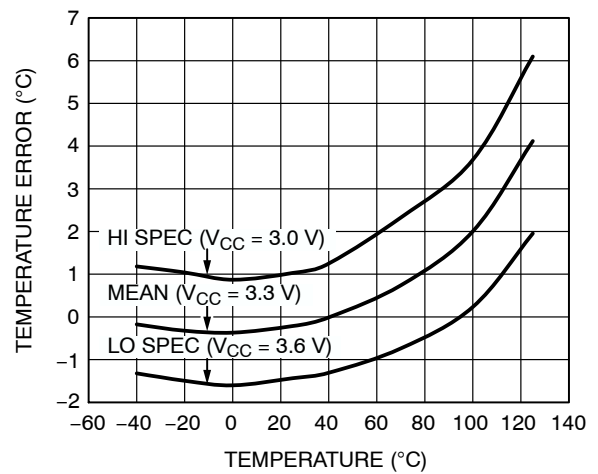

Figure 7. Remote Temperature Error

TYPICAL PERFORMANCE CHARACTERISTICS (Cont'd)

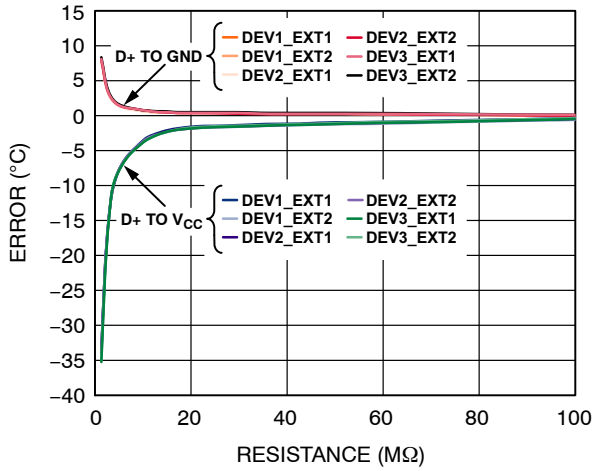

Figure 8. Remote Temperature Error vs. PCB Resistance

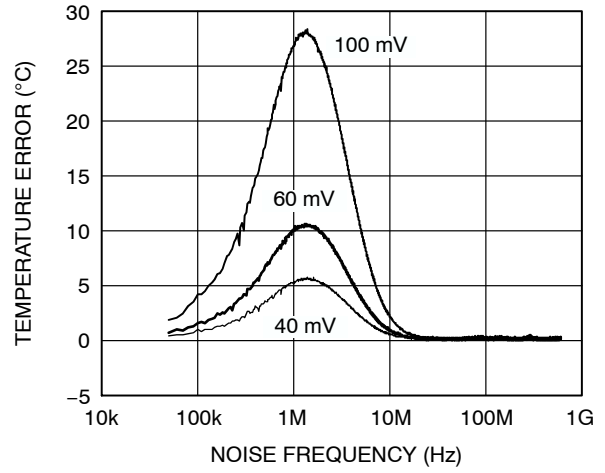

Figure 9. Temperature Error vs. Common-Mode Noise Frequency

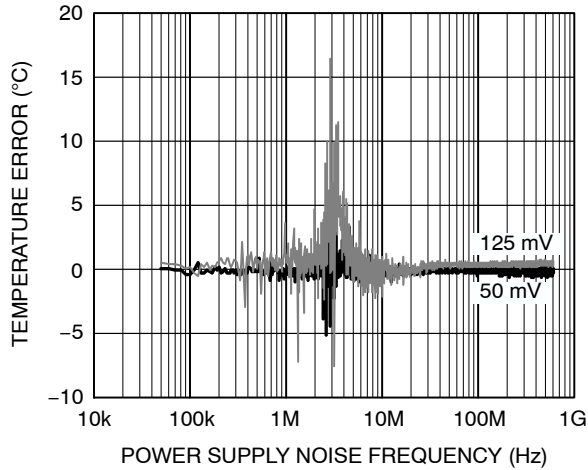

Figure 10. Local Temperature Error vs. Power Supply Noise

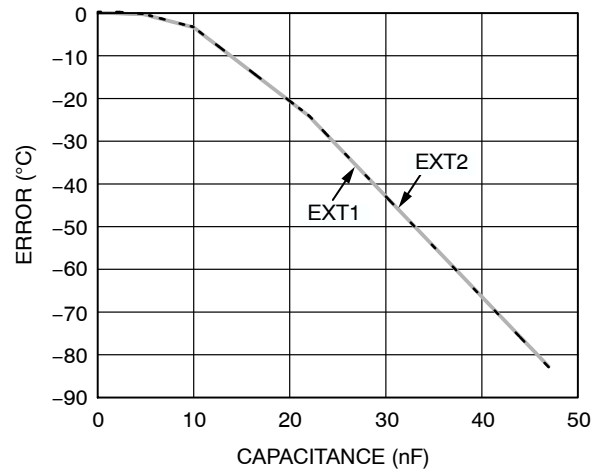

Figure 11. Remote Temperature Error vs. Capacitance Between D1+ and D1-

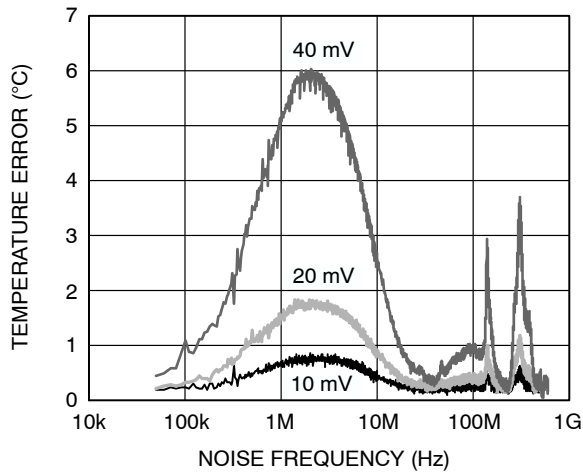

Figure 12. Temperature Error vs. Differential-Mode Noise Frequency

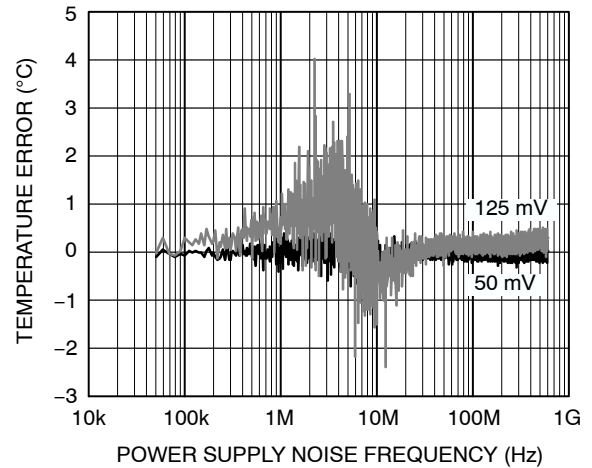

Figure 13. Remote Temperature Error vs. Power Supply Noise

# ADT7485A

## Product Description

The ADT7485A is a temperature- and voltage-monitoring device. The ADT7485A can monitor the temperature of one remote sensor diode, plus its own internal temperature. It can also monitor up to five voltage channels, including its own supply voltage.

## SST Interface

SST is a one-wire serial bus and a communications protocol between components intended for use in personal computers, personal hand-held devices, or other industrial sensor nets. The ADT7485A supports SST Rev 1.0.

SST is a licensable bus technology from Analog Devices, Inc., and Intel Corporation. To inquire about obtaining a copy of the Simple Serial Transport Specification or an SST technology license, please email Analog Devices at [sss\\_licensing@analog.com](mailto:sss_licensing@analog.com) or write to Analog Devices, 3550 North First Street, San Jose, CA 95134, Attention: SST Licensing, M/S B7-24.

## ADT7485A Client Address

The client address for the ADT7485A is selected using the address pin. The address pin is connected to a float detection circuit, which allows the ADT7485A to distinguish between three input states: high, low (GND), and floating. The address range for the fixed address, discoverable device is 0x48 to 0x4A.

**Table 5. ADT7485A SELECTABLE ADDRESSES**

ADD	Address Selected
Low (GND)	0x48
Float	0x49
High	0x4A

## Command Summary

Table 6 summarizes the commands supported by the ADT7485A device when directed at the target address selected by the fixed address pin. It contains the command name, command code (CC), write data length (WL), read data length (RL), and a brief description.

**Table 6. COMMAND CODE SUMMARY**

Command	Command Code, CC	Write Length, WL	Read Length, RL	Description
Ping()	0x00	0x00	0x00	Shows a nonzero FCS over the header if present.
GetIntTemp()	0x00	0x01	0x02	Shows the temperature of the device's internal thermal diode.
GetExtTemp()	0x01	0x01	0x02	Shows the temperature of External Thermal Diode.
GetAllTemps()	0x00	0x01	0x04	Returns a 4-byte block of data (GetIntTemp, GetExt1Temp).
GetVolt12V()	0x10	0x01	0x02	Shows the voltage attached to 12 V input.
GetVolt5V()	0x11	0x01	0x02	Shows the voltage attached to 5.0 V input.
GetVoltVCC()	0x12	0x01	0x02	Shows the voltage attached to V <sub>CC</sub> input.
GetVolt2.5V()	0x13	0x01	0x02	Shows the voltage attached to 2.5 V input.
GetVoltVCCP()	0x14	0x01	0x02	Shows the voltage attached to V <sub>CCP</sub> input.
GetAllVolts()	0x10	0x01	0x10	Shows all voltage measurement values.
SetExtOffset()	0xe0	0x02	0x00	Sets the offset used to correct errors in External Diode.
GetExtOffset()	0xe0	0x01	0x01	Shows the offset that the device is using to correct errors in External Diode.
ResetDevice()	0xf6	0x01	0x00	Functional reset. The ADT7485A also responds to this command when directed to the Target Address 0x00.
GetDIB()	0xf7 0xf7	0x01 0x01	0x08 0x10	Shows information used by SW to identify the device's capabilities. Can be in 8- or 16-byte format.

## Command Code Details

### ADT7485A Device Identifier Block

The GetDIB() command retrieves the device identifier block (DIB), which provides information to identify the capabilities of the ADT7485A. The data returned can be in 8- or 16-byte format. The full 16 bytes of DIB is detailed in

Table 7. The 8-byte format involves the first eight bytes described in this table. Byte-sized data is returned in the respective fields as it appears in Table 7. Word-sized data, including vendor ID, device ID, and data values use little endian format, that is, the LSB is returned first, followed by the MSB.

Table 7. 16-BYTE DIB DETAILS

Byte	Name	Value	Description
0	Device Capabilities	0xc0	Fixed Address Device
1	Version/Revision	0x10	Meets Version 1 of SST Specification
2, 3	Vendor ID	00x11d4	Contains Company ID Number in Little Endian Format
4, 5	Device ID	0x7485	Contains Device ID Number in Little Endian Format
6	Device Interface	0x01	SST Device
7	Function Interface	0x00	Reserved
8	Reserved	0x00	Reserved
9	Reserved	0x00	Reserved
10	Reserved	0x00	Reserved
11	Reserved	0x00	Reserved
12	Reserved	0x00	Reserved
13	Reserved	0x00	Reserved
14	Revision ID	0x05	Contains Revision ID
15	Client Device Address	0x48 to 0x4a	Dependent on the State of Address Pin

**Ping()**

The Ping() command verifies if a device is responding at a particular address. The ADT7485A shows a valid non-zero FCS in response to the Ping() command when correctly addressed.

Table 8. PING() COMMAND

Target Address	Write Length	Read Length	FCS
(Not Necessary)	0x00	0x00	

**ResetDevice()**

This command resets the register map and conversion controller. The reset command can be global or directed at the client address of the ADT7485A.

Table 9. RESETDEVICE() COMMAND

Target Address	Write Length	Read Length	Reset Command	FCS
Device Address	0x01	0x00	0xf6	

**GetIntTemp()**

The ADT7485A shows the local temperature of the device in response to the GetIntTemp() command. The data has a little endian, 16-bit, twos complement format.

**GetExtTemp()**

Prompted by the GetExtTemp() command, the ADT7485A shows the temperature of the remote diode in little endian,

16-bit, twos complement format. The ADT7485A shows 0x8000 in response to this command if the external diode is an open or short circuit.

**GetAllTemps()**

The ADT7485A shows the local and remote temperatures in a 4-byte block of data (internal temperature first, followed by external temperature) in response to a GetAllTemps() command.

**SetExtOffset()**

This command sets the offset that the ADT7485A will use to correct errors in the external diode. The offset is set in little endian, 16-bit, twos complement format. The maximum offset is  $\pm 128^{\circ}\text{C}$  with  $+0.25^{\circ}\text{C}$  resolution.

**GetExtOffset()**

This command causes the ADT7485A to show the offset that it is using to correct errors in the external diode. The offset value is returned in little endian format, that is, LSB before MSB.

**ADT7485A Response to Unsupported Commands**

A full list of command codes supported by the ADT7485A is given in Table 6. The offset registers (Command Code 0xe0) are the only registers that the user can write to. The other defined registers are read only. Writing to Register Addresses 0x02, 0x09, and 0x15 to 0xdf shows a valid FSC, but no action is taken by the ADT7485A. The ADT7485A shows an invalid FSC if the user attempts to write to the device between Command Codes 0xe2 to 0xee. These registers are reserved for the manufacturer's use only, and no data can be written to the device via these addresses.

**Voltage Measurement**

The ADT7485A has four external voltage measurement channels. It can also measure its own supply voltage,  $V_{CC}$ . Pins 5 and 8 measure the supplies of the 12 V, 5.0 V, processor core voltage ( $V_{CCP}$ ), and 2.5 V pins, respectively. The  $V_{CC}$  supply voltage measurement is carried out through the  $V_{CC}$  pin (Pin 1). The 2.5 V pin can be used to monitor a chip-set supply voltage in a computer system.

**Analog-to-Digital Converter**

All analog inputs are multiplexed into the on-chip, successive approximation, analog-to-digital converter (ADC). This has a resolution of 10 bits. The basic input range is 0 V to 2.25 V, but the inputs have built-in attenuators to allow measurement of 2.5 V, 3.3 V, 5.0 V, 12 V, and the processor core voltage ( $V_{CCP}$ ) without any external components.

To allow for the tolerance of these supply voltages, the ADC produces a specific output for each nominal input voltage and therefore has adequate headroom to cope with overvoltage. The full-scale voltage that can be recorded for each channel is shown in Table 10.

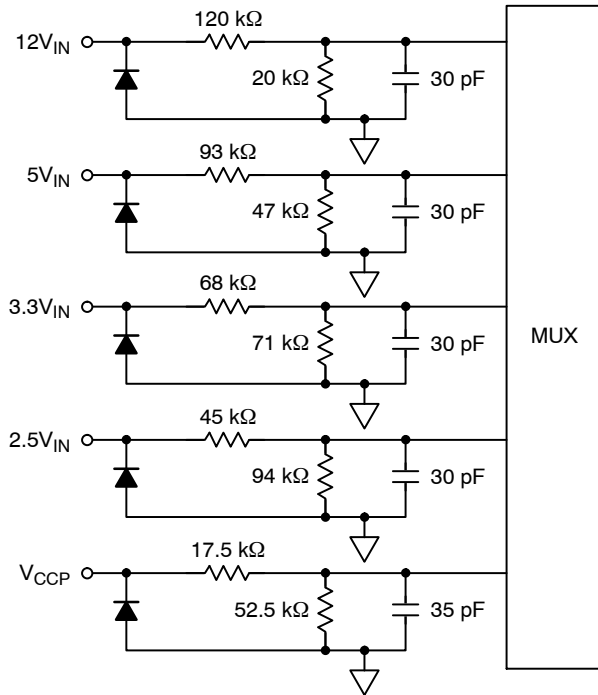

**Table 10. MAXIMUM REPORTED INPUT VOLTAGES**

Voltage Channel	Full-scale Voltage
12 V	16 V
5.0 V	8.0 V
V <sub>CC</sub>	4.0 V
2.5 V	4.0 V
V <sub>CCP</sub>	4.0 V

**Input Circuitry**

The internal structure for the analog inputs is shown in Figure 14. The input circuit consists of an input protection diode and an attenuator, plus a capacitor that forms a first-order, low-pass filter to provide input immunity to high frequency noise.



**Figure 14. Internal Structure of Analog Inputs**

**Voltage Measurement Command Codes**

The voltage measurement command codes are detailed in Table 11. Each voltage measurement has a read length of two bytes in little endian format (LSB followed by MSB). All voltages can be read together by addressing Command Code 0x10 with a read length of 0x10. The data is retrieved in the order listed in Table 11.

**Table 11. VOLTAGE MEASUREMENT COMMAND CODE**

Voltage Channel	Command Code	Returned Data
12 V	0x10	LSB, MSB
5.0 V	0x11	LSB, MSB
V <sub>CC</sub>	0x12	LSB, MSB
2.5 V	0x13	LSB, MSB
V <sub>CCP</sub>	0x14	LSB, MSB

**Voltage Data Format**

The returned voltage value is in twos complement, 16-bit, binary format. The format is structured so that voltages in the range of ±32 V can be reported. In this way, the reported value represents the number of 1/1024 V in the actual reading, allowing a resolution of approximately 1 mV.

**Table 12. ANALOG-TO-DIGITAL OUTPUT VS. V<sub>IN</sub>**

Voltage	Twos Complement	
	MSB	LSB
12	0011 0000	0000 0000
5.0	0001 0100	0000 0000
3.3	0000 1101	0011 0011
3.0	0000 1100	0000 0000
2.5	0000 1010	0000 0000
1.0	0000 0100	0000 0000
0	0000 0000	0000 0000

**Temperature Measurement**

The ADT7485A has two dedicated temperature measurement channels: one for measuring the temperature of an on-chip band gap temperature sensor, and one for measuring the temperature of a remote diode, usually located in the CPU or GPU.

The ADT7485A monitors one local and one remote temperature channel. Monitoring of each of the channels is done in a round-robin sequence. The monitoring sequence is in the order shown in Table 13.

**Table 13. TEMPERATURE MONITORING SEQUENCE**

Channel Number	Measurement	Conversion Time (ms)
0	Local Temperature	12
1	Remote 1 Temperature	38

**Temperature Measurement Method**

A simple method for measuring temperature is to exploit the negative temperature coefficient of a diode by measuring the base-emitter voltage (V<sub>BE</sub>) of a transistor operated at constant current. Unfortunately, this technique requires calibration to null the effect of the absolute value of V<sub>BE</sub>, which varies from device to device.

The technique used in the ADT7485A measures the change in V<sub>BE</sub> when the device is operated at three different currents.

Figure 15 shows the input signal conditioning used to measure the output of a remote temperature sensor. This figure shows the remote sensor as a substrate transistor, which is provided for temperature monitoring on some microprocessors, but it could also be a discrete transistor. If a discrete transistor is used, the collector is not grounded and should be linked to the base. To prevent ground noise from interfering with the measurement, the more negative terminal of the sensor is not referenced to ground, but is

biased above ground by an internal diode at the D1- input. If the sensor is operating in an extremely noisy environment,

C1 can be added as a noise filter. Its value should not exceed 1,000 pF.

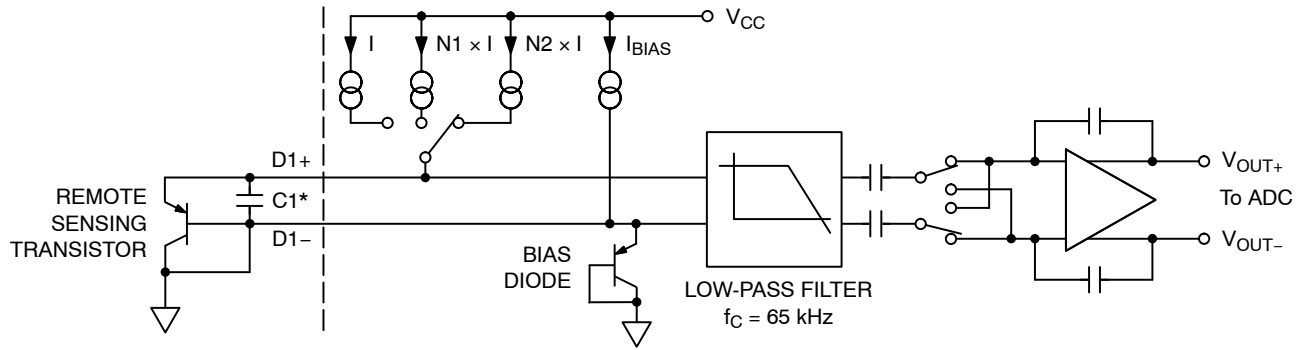

\*CAPACITOR C1 IS OPTIONAL. IT SHOULD ONLY BE USED IN NOISY ENVIRONMENTS.

Figure 15. Signal Conditioning for Remote Diode Temperature Sensors

To measure  $\Delta V_{BE}$ , the operating current through the sensor is switched between three related currents. Figure 15 shows  $N1 \times I$  and  $N2 \times I$  as different multiples of the current  $I$ . The currents through the temperature diode are switched between  $I$  and  $N1 \times I$ , giving  $\Delta V_{BE1}$ , and then between  $I$  and  $N2 \times I$ , giving  $\Delta V_{BE2}$ . The temperature can then be calculated using the two  $\Delta V_{BE}$  measurements. This method can also cancel the effect of series resistance on the temperature measurement. The resulting  $\Delta V_{BE}$  waveforms are passed through a 65 kHz low-pass filter to remove noise and then through a chopper-stabilized amplifier to amplify and rectify the waveform, producing a dc voltage proportional to  $\Delta V_{BE}$ . The ADC digitizes this voltage, and a temperature measurement is produced. To reduce the effects of noise, digital filtering is performed by averaging the results of 16 measurement cycles for low conversion rates. Signal conditioning and measurement of the internal temperature sensor is performed in the same manner.

sensor format uses a twos complement, 16-bit binary value to represent values in this range. This format allows temperatures to be represented with approximately a 0.016°C resolution.

**Reading Temperature Measurements**

The temperature data returned is two bytes in little endian format, that is, LSB before MSB. All temperatures can be read together by using Command Code 0x00 with a read length of 0x04. The command codes and returned data are described in Table 14.

Table 15. SST TEMPERATURE DATA FORMAT

Temperature (°C)	Twos Complement	
	MSB	LSB
-125	1110 0000	1100 0000
-80	1110 1100	0000 0000
-40	1111 0110	0000 0000
-20	1111 1011	0011 1110
-5	1111 1110	1100 0000
-1	1111 1111	1100 0000
0	0000 0000	0000 0000
+1	0000 0000	0100 0000
+5	0000 0001	0100 0000
+20	0000 0100	1100 0010
+40	0000 1010	0000 0000
+80	0001 0100	0000 0000
+125	0001 1111	0100 0000

Table 14. TEMPERATURE CHANNEL COMMAND CODES

Temp Channel	Command Code	Returned Data
Internal	0x00	LSB, MSB
External	0x01	LSB, MSB
All Temps	0x00	Internal LSB, Internal MSB; External LSB, External MSB

**SST Temperature Sensor Data Format**

The data for temperature is structured to allow values in the range of  $\pm 512^\circ\text{C}$  to be reported. Thus, the temperature

**Using Discrete Transistors**

If a discrete transistor is used, the collector is not grounded and should be linked to the base. If a PNP transistor is used, the base is connected to the D- input and the emitter is connected to the D+ input. If an NPN transistor is used, the emitter is connected to the D- input and the base is connected to the D+ input.

Figure 16 shows how to connect the ADT7485A to an NPN or PNP transistor for temperature measurement. To prevent ground noise from interfering with the measurement, the more negative terminal of the sensor is not referenced to ground, but is biased above ground by an internal diode at the D1- input.

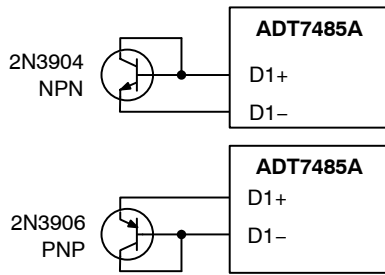

**Figure 16. Connections for NPN and PNP Transistors**

The ADT7485A shows an external temperature value of 0x8000 if the external diode is an open or short circuit.

**Layout Considerations**

Digital boards can be electrically noisy environments. Take the following precautions to protect the analog inputs from noise, particularly when measuring the very small voltages from a remote diode sensor:

1. Place the ADT7485A as close as possible to the remote sensing diode. Provided that the worst noise sources, such as clock generators, data/address buses, and CRTs, are avoided, this distance can be four to eight inches.
2. Route the D1+ and D1- tracks close together in parallel with grounded guard tracks on each side. Provide a ground plane under the tracks if possible.
3. Use wide tracks to minimize inductance and reduce noise pickup. A 5 mil track minimum width and spacing is recommended.



**Figure 17. Arrangement of Signal Tracks**

4. Try to minimize the number of copper/solder joints, which can cause thermocouple effects. Where copper/solder joints are used, make sure that they are in both the D1+ and D1- paths and are at the same temperature.

5. Thermocouple effects should not be a major problem because 1°C corresponds to about 240 μV, and thermocouple voltages are about 3 μV/°C of the temperature difference. Unless there are two thermocouples with a big temperature differential between them, thermocouple voltages should be much less than 200 mV.
6. Place a 0.1 μF bypass capacitor close to the ADT7485A.
7. If the distance to the remote sensor is more than eight inches, the use of a twisted pair cable is recommended. This works for distances of about 6 feet to 12 feet.
8. For very long distances (up to 100 feet), use shielded twisted pair cables, such as Belden #8451 microphone cables. Connect the twisted pair cable to D+ and D- and the shield to GND, close to the ADT7485A. Leave the remote end of the shield unconnected to avoid ground loops.

Because the measurement technique uses switched current sources, excessive cable and/or filter capacitance can affect the measurement. When using long cables, the filter capacitor can be reduced or removed. Cable resistance can also introduce errors. A 1 Ω series resistance introduces about 0.5°C error.

**Temperature Offset**

As CPUs run faster, it is more difficult to avoid high frequency clocks when routing the D+ and D- tracks around a system board. Even when the recommended layout guidelines are followed, there may still be temperature errors, attributed to noise being coupled onto the D+ and D- lines. High frequency noise generally has the effect of producing temperature measurements that are consistently too high by a specific amount. The ADT7485A has temperature offset command code of 0xe0 through which a desired offset can be set. By doing a one-time calibration of the system, the offset caused by system board noise can be calculated and nulled by specifying it in the ADT7485A. The offset is automatically added to every temperature measurement. The maximum offset is ±128°C with 0.25°C resolution. The offset format is the same as the temperature data format; 16-bit, twos complement notation, as shown in Table 15. The offset should be programmed in little endian format, that is, LSB before MSB. The offset value is also returned in little endian format when read.

**Table 16. ORDERING INFORMATION**

Device Order Number*	Package Type	Package Option	Shipping†
ADT7485AARMZ-R	10-lead MSOP	RM-10	3,000 Tape & Reel

†For information on tape and reel specifications, including part orientation and tape sizes, please refer to our Tape and Reel Packaging Specifications Brochure, BRD8011/D.

\*This is Pb-Free package.

# ADT7485A

## PACKAGE DIMENSIONS

MSOP-10  
CASE 846AC-01  
ISSUE O

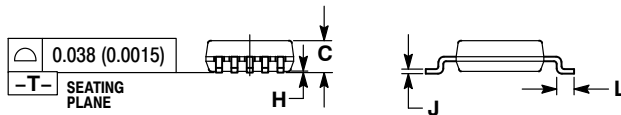
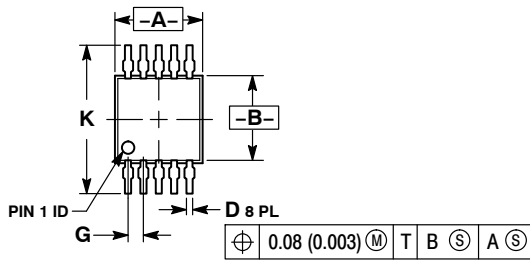

### NOTES:

1. DIMENSIONING AND TOLERANCING PER ANSI Y14.5M, 1982.
2. CONTROLLING DIMENSION: MILLIMETER.
3. DIMENSION "A" DOES NOT INCLUDE MOLD FLASH, PROTRUSIONS OR GATE BURRS. MOLD FLASH, PROTRUSIONS OR GATE BURRS SHALL NOT EXCEED 0.15 (0.006) PER SIDE.
4. DIMENSION "B" DOES NOT INCLUDE INTERLEAD FLASH OR PROTRUSION. INTERLEAD FLASH OR PROTRUSION SHALL NOT EXCEED 0.25 (0.010) PER SIDE.
5. 846B-01 OBSOLETE. NEW STANDARD 846B-02

DIM	MILLIMETERS		INCHES	
	MIN	MAX	MIN	MAX
A	2.90	3.10	0.114	0.122
B	2.90	3.10	0.114	0.122
C	0.95	1.10	0.037	0.043
D	0.20	0.30	0.008	0.012
G	0.50 BSC		0.020 BSC	
H	0.05	0.15	0.002	0.006
J	0.10	0.21	0.004	0.008
K	4.75	5.05	0.187	0.199
L	0.40	0.70	0.016	0.028

### SOLDERING FOOTPRINT\*

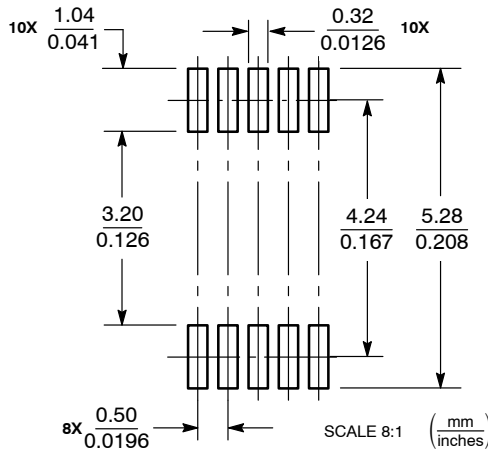

\*For additional information on our Pb-Free strategy and soldering details, please download the ON Semiconductor Soldering and Mounting Techniques Reference Manual, SOLDERRM/D.

SST is a licensable bus technology from Analog Devices, Inc., and Intel Corporation.

ON Semiconductor and are registered trademarks of Semiconductor Components Industries, LLC (SCILLC). SCILLC owns the rights to a number of patents, trademarks, copyrights, trade secrets, and other intellectual property. A listing of SCILLC's product/patent coverage may be accessed at [www.onsemi.com/site/pdf/Patent-Marking.pdf](http://www.onsemi.com/site/pdf/Patent-Marking.pdf). SCILLC reserves the right to make changes without further notice to any products herein. SCILLC makes no warranty, representation or guarantee regarding the suitability of its products for any particular purpose, nor does SCILLC assume any liability arising out of the application or use of any product or circuit, and specifically disclaims any and all liability, including without limitation special, consequential or incidental damages. "Typical" parameters which may be provided in SCILLC data sheets and/or specifications can and do vary in different applications and actual performance may vary over time. All operating parameters, including "Typicals" must be validated for each customer application by customer's technical experts. SCILLC does not convey any license under its patent rights nor the rights of others. SCILLC products are not designed, intended, or authorized for use as components in systems intended for surgical implant into the body, or other applications intended to support or sustain life, or for any other application in which the failure of the SCILLC product could create a situation where personal injury or death may occur. Should Buyer purchase or use SCILLC products for any such unintended or unauthorized application, Buyer shall indemnify and hold SCILLC and its officers, employees, subsidiaries, affiliates, and distributors harmless against all claims, costs, damages, and expenses, and reasonable attorney fees arising out of, directly or indirectly, any claim of personal injury or death associated with such unintended or unauthorized use, even if such claim alleges that SCILLC was negligent regarding the design or manufacture of the part. SCILLC is an Equal Opportunity/Affirmative Action Employer. This literature is subject to all applicable copyright laws and is not for resale in any manner.

### PUBLICATION ORDERING INFORMATION

**LITERATURE FULFILLMENT:**  
Literature Distribution Center for ON Semiconductor  
P.O. Box 5163, Denver, Colorado 80217 USA  
**Phone:** 303-675-2175 or 800-344-3860 Toll Free USA/Canada  
**Fax:** 303-675-2176 or 800-344-3867 Toll Free USA/Canada  
**Email:** [orderlit@onsemi.com](mailto:orderlit@onsemi.com)

**N. American Technical Support:** 800-282-9855 Toll Free  
USA/Canada  
**Europe, Middle East and Africa Technical Support:**  
Phone: 421 33 790 2910  
**Japan Customer Focus Center**  
Phone: 81-3-5817-1050

**ON Semiconductor Website:** [www.onsemi.com](http://www.onsemi.com)  
**Order Literature:** <http://www.onsemi.com/orderlit>  
For additional information, please contact your local Sales Representative

# Mouser Electronics

Authorized Distributor

Click to View Pricing, Inventory, Delivery & Lifecycle Information:

[onsemi:](#)

[ADT7485AARMZ-R](#) [ADT7485AARMZ-R7](#)