

Rating and Characteristic Curves (CDBMH220-HF Thru. CDBMH2100-HF)

Fig.1- Typical Current Derating Curve

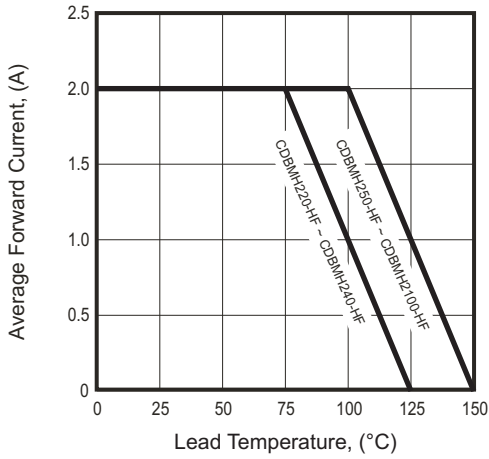

Fig.2- Typical Forward Characteristics

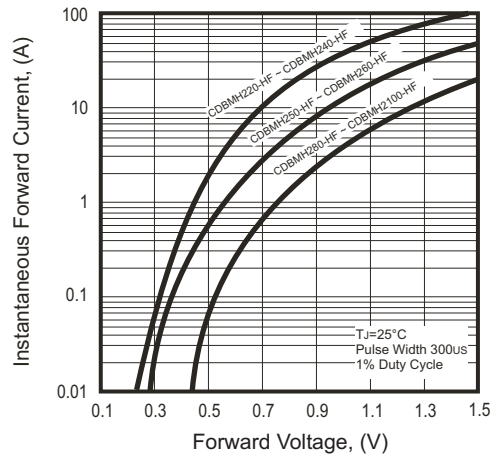

Fig.3- Maximum Non-repetitive Forward Surge Current

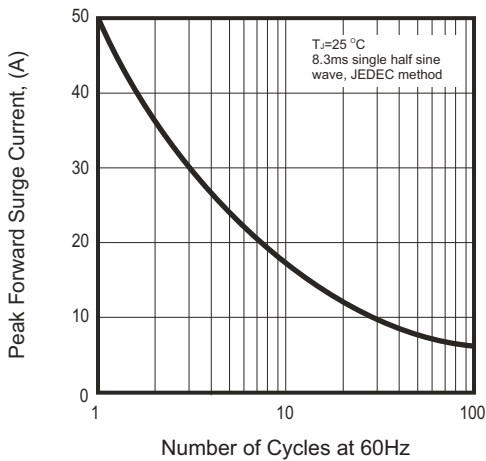

Fig.4- Typical Junction Capacitance

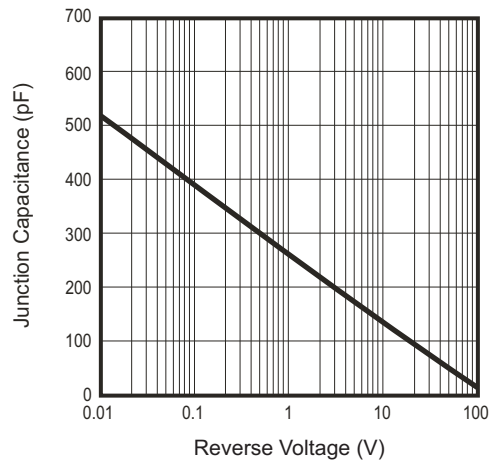
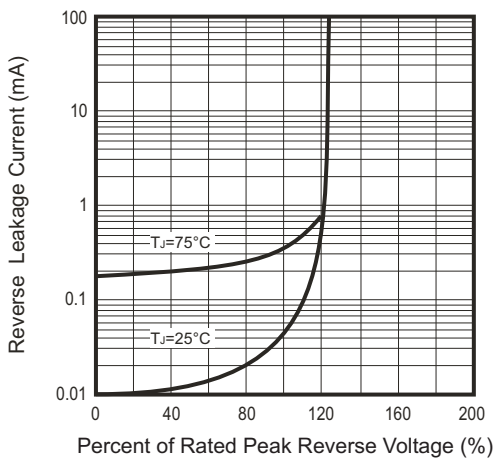
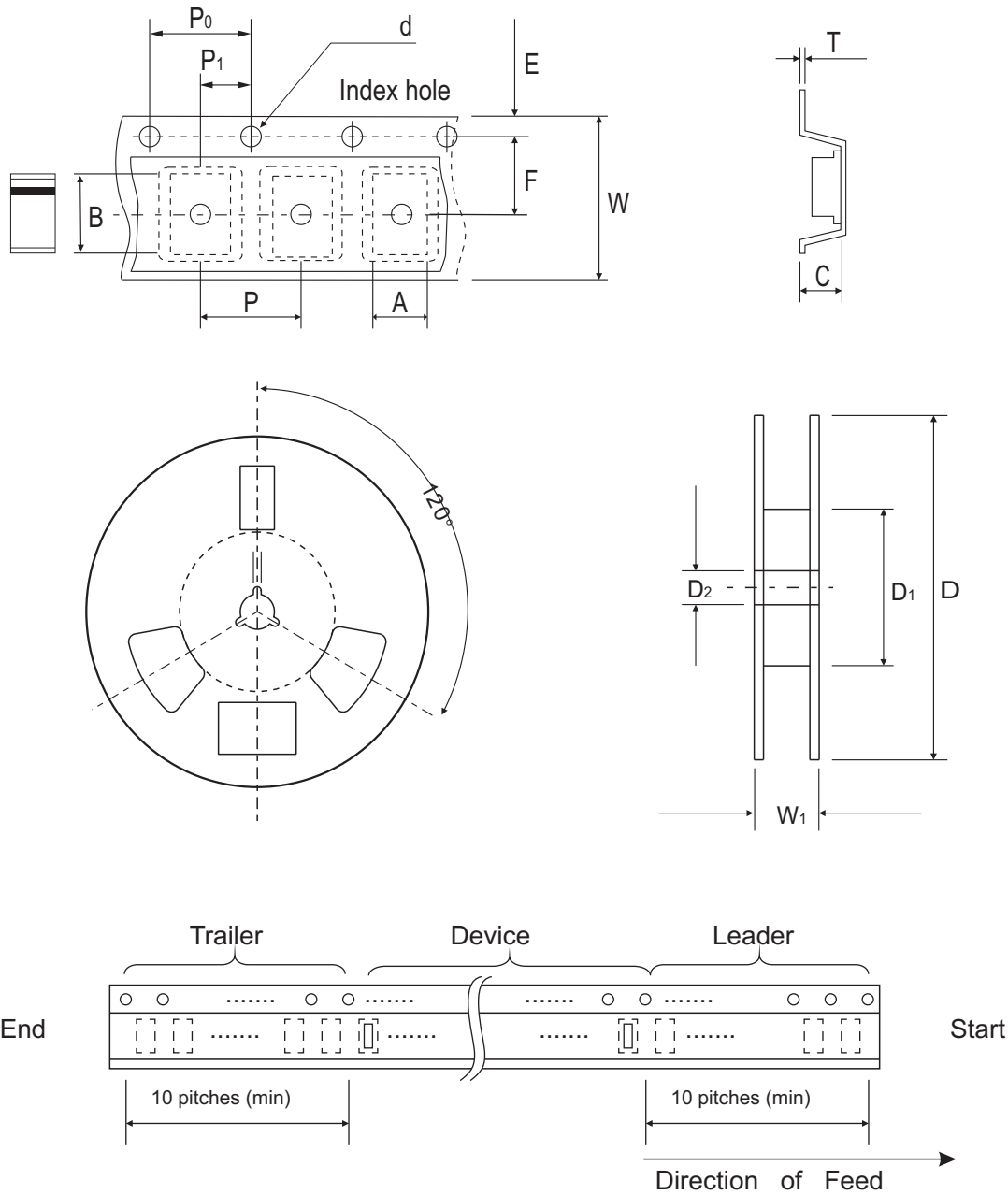

Fig.5- Reverse Characteristics



Reel Taping Specification



Mini-SMA / SOD-123T	SYMBOL	A	B	C	d	D	D1	D2
	(mm)	1.90 ± 0.10	3.90 ± 0.10	1.68 ± 0.10	1.50 ± 0.10	178.00 ± 2.00	62.00 (min)	13.00 ± 0.50
	(inch)	0.075 ± 0.004	0.154 ± 0.004	0.066 ± 0.004	0.059 ± 0.004	7.007 ± 0.079	2.441 (min)	0.512 ± 0.020

Mini-SMA / SOD-123T	SYMBOL	E	F	P	P0	P1	T	W	W1
	(mm)	1.75 ± 0.10	3.50 ± 0.10	4.00 ± 0.10	4.00 ± 0.10	2.00 ± 0.10	0.23 ± 0.10	8.00 ± 0.30	11.40 ± 1.00
	(inch)	0.069 ± 0.004	0.138 ± 0.004	0.157 ± 0.004	0.157 ± 0.004	0.079 ± 0.004	0.009 ± 0.04	0.315 ± 0.012	0.449 ± 0.039

Pinning information

Pin	Simplified outline	Symbol
PIN 1 Cathode PIN 2 Anode		

Marking Code

Part Number	Marking Code
CDBMH220-HF	22
CDBMH230-HF	23
CDBMH240-HF	24
CDBMH250-HF	25
CDBMH260-HF	26
CDBMH280-HF	28
CDBMH2100-HF	20



xx = Product type marking code

Suggested PAD Layout

SIZE	Mini-SMA/SOD-123T	
	(mm)	(inch)
A	1.00	0.040
B	1.00	0.040
C	1.70	0.067
D	0.50	0.020
E	1.50	0.060
F	1.10	0.044
G	0.90	0.036
H	0.85	0.034
I	0.60	0.024

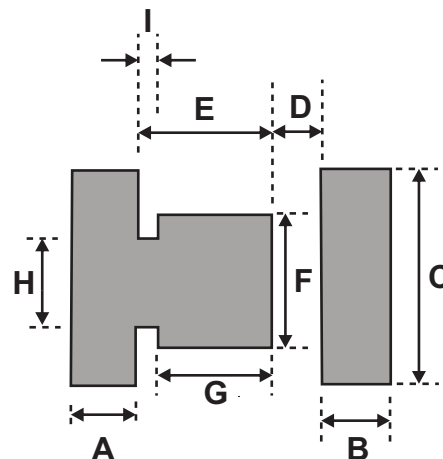

Standard Packaging

Case Type	REEL PACK	
	REEL (pcs)	Reel Size (inch)
SOD-123T	2,500	7

Mouser Electronics

Authorized Distributor

Click to View Pricing, Inventory, Delivery & Lifecycle Information:

Comchip Technology:

[CDBMH220-HF](#) [CDBMH250-HF](#) [CDBMH240-HF](#) [CDBMH2100-HF](#) [CDBMH280-HF](#) [CDBMH230-HF](#) [CDBMH260-HF](#)