

MAX4426/MAX4427/MAX4428

Dual High-Speed 1.5A MOSFET Drivers

ABSOLUTE MAXIMUM RATINGS

Supply Voltage V_{DD} to GND +20V
 Time $V_{IL} < V_{IN} < V_{IH}$ 50ns
 Input Voltage $V_{DD} + 0.3V$ to GND - 0.3V
 Continuous Power Dissipation ($T_A = +70^\circ\text{C}$)
 Plastic DIP (derate 9.09mW/ $^\circ\text{C}$ above $+70^\circ\text{C}$) 727mW
 SO (derate 5.88mW/ $^\circ\text{C}$ above $+70^\circ\text{C}$) 471mW
 CERDIP (derate 8.00mW/ $^\circ\text{C}$ above $+70^\circ\text{C}$) 640mW

Operating Temperature Ranges:
 MAX442_C_ 0°C to $+70^\circ\text{C}$
 MAX442_E_ -40°C to $+85^\circ\text{C}$
 MAX442_MJA -55°C to $+125^\circ\text{C}$
 Storage Temperature Range -55°C to $+160^\circ\text{C}$
 Maximum Chip Temperature $+150^\circ\text{C}$
 Lead Temperature (soldering, 10 sec) $+300^\circ\text{C}$

Stresses beyond those listed under "Absolute Maximum Ratings" may cause permanent damage to the device. These are stress ratings only, and functional operation of the device at these or any other conditions beyond those indicated in the operational sections of the specifications is not implied. Exposure to absolute maximum rating conditions for extended periods may affect device reliability.

ELECTRICAL CHARACTERISTICS

($V_{DD} = +4.5V$ to $+18V$, $T_A = T_{MIN}$ to T_{MAX} , unless otherwise specified.)

PARAMETER	SYMBOL	CONDITIONS		MIN	TYP	MAX	UNITS
Logic 1 Input Voltage	V_{IH}			2.4			V
Logic 0 Input Voltage	V_{IL}					0.8	V
Input Current	I_{IN}	$V_{IN} = 0V$ to $18V$		-1		1	μA
Output High Voltage	V_{OH}	No load		$V_{DD} - 25$			mV
Output Low Voltage	V_{OL}	No load				25	mV
Output Resistance	R_{OUT}	$V_{DD} = 18V$, $I_{LOAD} = 10mA$	$V_{IN} = 0.8V$ for inverting stages, $V_{IN} = 2.4V$ for noninverting stages	$T_A = +25^\circ\text{C}$	4	10	Ω
				$T_A = T_{MIN}$ to T_{MAX}	5	12	
			$V_{IN} = 2.4V$ for inverting stages, $V_{IN} = 0.8V$ for noninverting stages	$T_A = +25^\circ\text{C}$	4	10	
				$T_A = T_{MIN}$ to T_{MAX}	5	12	
Peak Output Current	I_{PK}	$V_{DD} = 18V$			1.5		A
Power-Supply Current	I_{SUPP}	$V_{IN} = +3V$ for both inputs	$T_A = +25^\circ\text{C}$	1.8	4.5	mA	
			$T_A = T_{MIN}$ to T_{MAX}	2.5	8.0		
		$V_{IN} = 0V$ for both inputs	$T_A = +25^\circ\text{C}$	0.2	0.4		
			$T_A = T_{MIN}$ to T_{MAX}	0.3	0.6		
Rise Time (Note 1)	t_R	$T_A = +25^\circ\text{C}$		20	30	ns	
		$T_A = T_{MIN}$ to T_{MAX}		25	40		
Fall Time (Note 1)	t_F	$T_A = +25^\circ\text{C}$		20	30	ns	
		$T_A = T_{MIN}$ to T_{MAX}		25	40		
Delay Time (Note 1)	t_{D1}	$T_A = +25^\circ\text{C}$		10	30	ns	
		$T_A = T_{MIN}$ to T_{MAX}		15	40		
	t_{D2}	$T_A = +25^\circ\text{C}$		25	50	ns	
		$T_A = T_{MIN}$ to T_{MAX}		30	60		

Note 1: Switching times guaranteed by design, not tested. See Figure 1 for timing measurement circuit.

MAX4426/MAX4427/MAX4428

Dual High-Speed 1.5A MOSFET Drivers

Typical Operating Characteristics

MAX4426 RISE AND FALL TIME vs. SUPPLY VOLTAGE

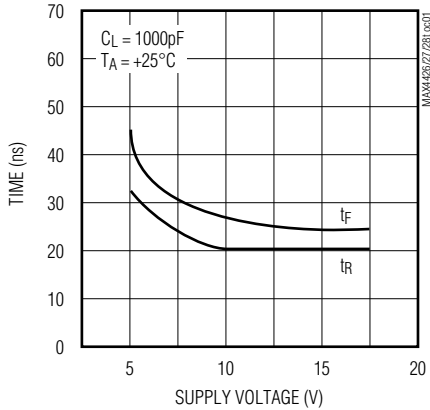

MAX4426 DELAY TIME vs. SUPPLY VOLTAGE

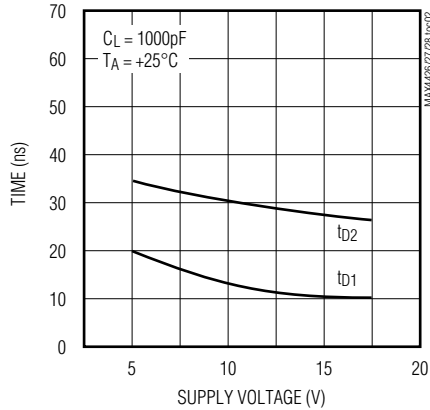

MAX4426 RISE AND FALL TIME vs. TEMPERATURE

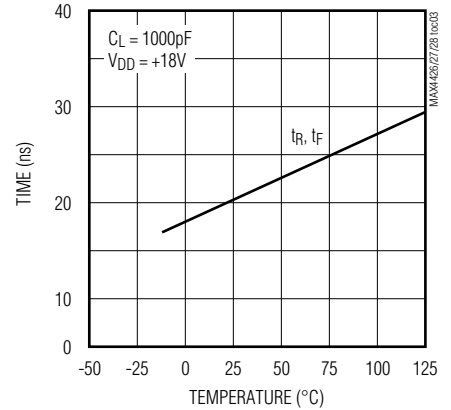

MAX4426 DELAY TIME vs. TEMPERATURE

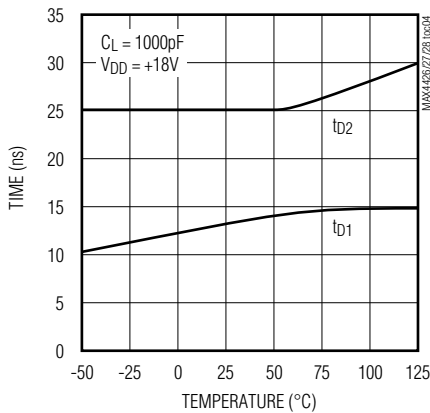

MAX4426 SUPPLY CURRENT vs. CAPACITIVE LOAD

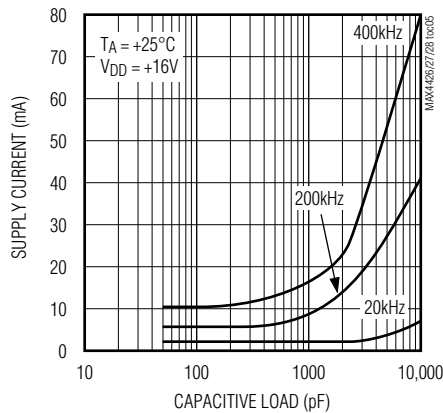

MAX4426 RISE AND FALL TIME vs. CAPACITIVE LOAD

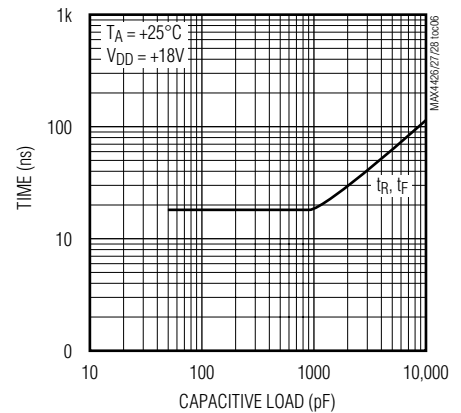

MAX4426 SUPPLY CURRENT vs. FREQUENCY

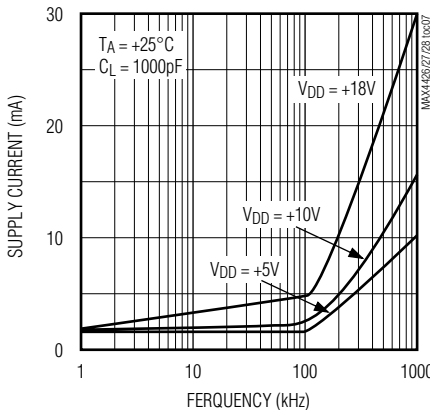

MAX4426 OUTPUT HIGH VOLTAGE vs. SOURCE CURRENT

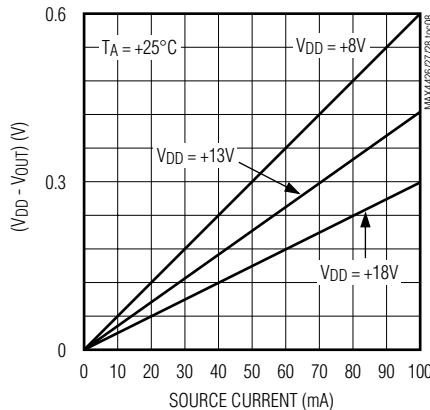

MAX4426 OUTPUT LOW VOLTAGE vs. SOURCE CURRENT

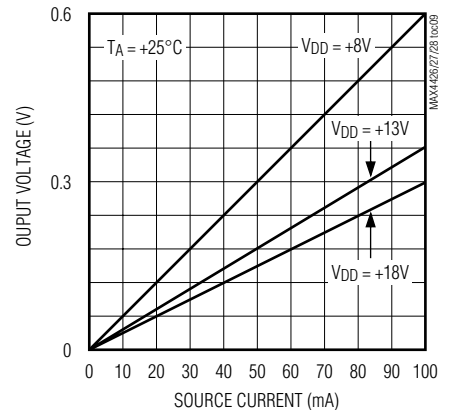

MAX4426/MAX4427/MAX4428

Dual High-Speed 1.5A MOSFET Drivers

Applications Information

The MAX4426/MAX4427/MAX4428 have easy-to-drive inputs. However, these inputs must never be allowed to stay between V_{IH} and V_{IL} for more than 50ns. Unused inputs should always be connected to ground to minimize supply current. Drivers can be paralleled on the MAX4426 or MAX4427 by tying both Inputs together and both outputs together.

Supply bypassing and grounding are extremely important with the MAX4426/MAX4427/MAX4428, as the peak supply current can be as high as 3A, which is twice the peak output current. Ground drops are a form of negative feedback with inverters, and hence will degrade the delay and transition time of the MAX4426/MAX4428.

Suggested bypass capacitors are a 4.7 μ F (low ESR) capacitor in parallel with a 0.1 μ F ceramic capacitor, mounted as close as possible to the MAX4426/MAX4427/MAX4428. Use a ground plane if possible or separate ground returns for inputs and outputs. Output voltage ringing can be minimized with a 5 Ω to 20 Ω resistor in series with the output, but this will degrade output transition time. Ringing may be undesirable due to the large current that flows through capacitive loads when the voltage across these loads transitions quickly.

Operation at the upper end of the supply voltage range (> 15V) requires that a capacitance of at least 50pF be present at the outputs. This prevents the supply voltage provided to the die (which can be different from that seen at the supply pin) from exceeding the 20V absolute maximum rating, due to overshoot. Since at least 50pF of gate capacitance is present in all higher power FETs, this requirement is easily met.

Power Dissipation

The MAX4426/MAX4427/MAX4428 power dissipation consists of input inverter losses, crowbar current through the output devices, and output current (either capacitive or resistive). The sum of these must be kept below the maximum power dissipation limit.

The DC input inverter supply current is 0.2mA when both inputs are low and 2mA when both inputs are high. The crowbar current through an output device making a transition is approximately 100mA for a few nanoseconds. This is a small portion of the total supply current, except for high switching frequencies or a small load capacitance (100pF).

The MAX4426/MAX4427/MAX4428 power dissipation when driving a ground-referenced resistive load is:

$$P = (D) (r_{ON(MAX)}) (I_{LOAD})^2$$

where D is the percentage of time the MAX4426/MAX4427/MAX4428 output pulls high, $r_{ON(MAX)}$ is the MAX4426/MAX4427/MAX4428 maximum on resistance, and I_{LOAD} is the MAX4426/MAX4427/MAX4428 load current.

For capacitive loads, the power dissipation is:

$$P = (C_{LOAD}) (V_{DD})^2 (FREQ)$$

where C_{LOAD} is the capacitive load, V_{DD} is the MAX4426/MAX4427/MAX4428 supply voltage, and FREQ is the toggle frequency.

MAX4426/MAX4427/MAX4428

Dual High-Speed 1.5A MOSFET Drivers

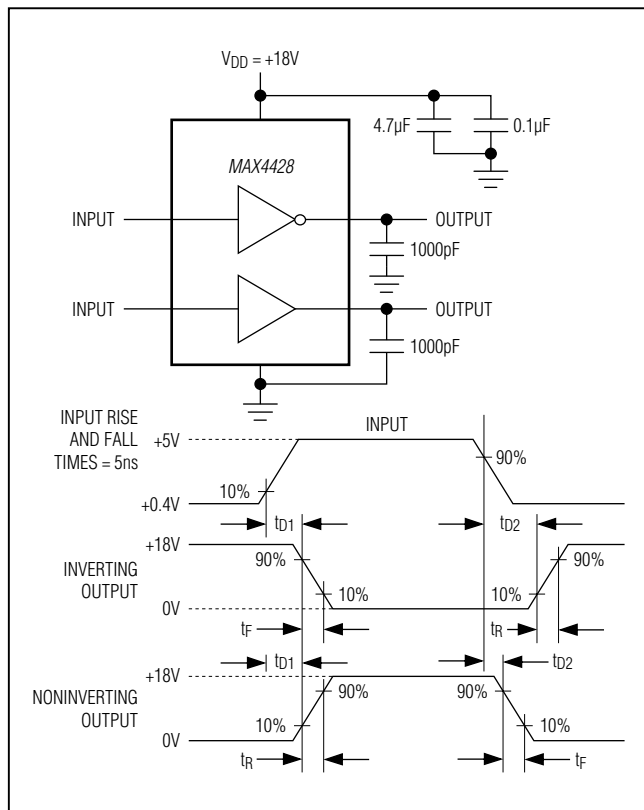

Figure 1. Inverting and Noninverting Test Circuit

Ordering Information (continued)

PART	TEMP RANGE	PIN-PACKAGE
MAX4427CPA	0°C to +70°C	8 Plastic DIP
MAX4427CSA	0°C to +70°C	8 SO
MAX4427C/D	0°C to +70°C	Dice*
MAX4427EPA	-40°C to +85°C	8 Plastic DIP
MAX4427ESA	-40°C to +85°C	8 SO
MAX4427EJA	-40°C to +85°C	8 CERDIP
MAX4427MJA	-55°C to +125°C	8 CERDIP**
MAX4428CPA	0°C to +70°C	8 Plastic DIP
MAX4428CSA	0°C to +70°C	8 SO
MAX4428C/D	0°C to +70°C	Dice*
MAX4428EPA	-40°C to +85°C	8 Plastic DIP
MAX4428ESA	-40°C to +85°C	8 SO
MAX4428EJA	-40°C to +85°C	8 CERDIP
MAX4428MJA	-55°C to +125°C	8 CERDIP**

*Dice are tested at $T_A = +25^\circ\text{C}$.

**Contact factory for availability and processing to MIL-STD-883.

Chip Topography

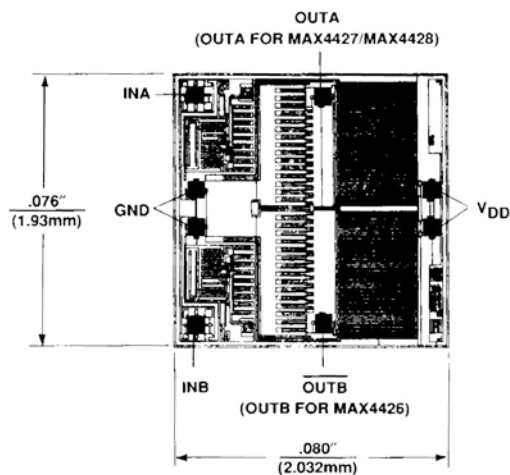

SUBSTRATE CONNECTED TO V_{DD} ;

TRANSISTOR COUNT: 26.

MAX4427/MAX4428

MAX4426/MAX4427/MAX4428

Dual High-Speed 1.5A MOSFET Drivers

Package Information

(The package drawing(s) in this data sheet may not reflect the most current specifications. For the latest package outline information go to www.maxim-ic.com/packages.)

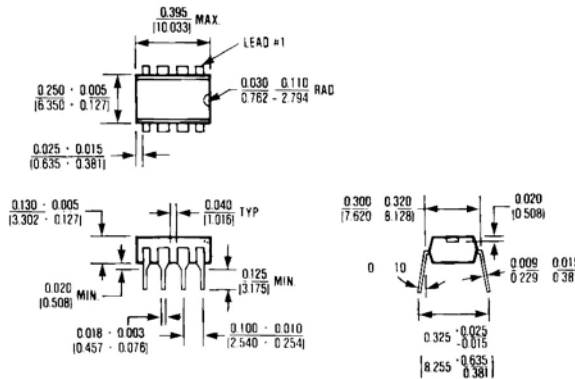

8 Lead Plastic DIP

$\theta_{JA} = 120^{\circ} \text{C/W}$

$\theta_{JC} = 70^{\circ} \text{C/W}$

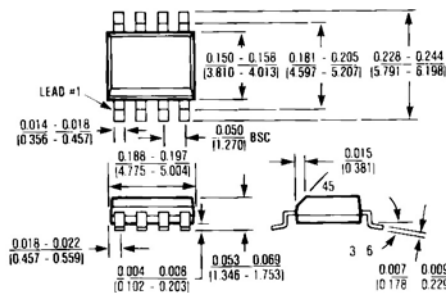

8 Lead Small Outline

$\theta_{JA} = 170^{\circ} \text{C/W}$

$\theta_{JC} = 80^{\circ} \text{C/W}$

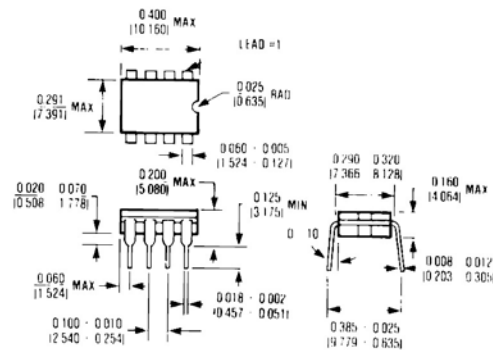

8 Lead Cerdip

$\theta_{JA} = 125^{\circ} \text{C/W}$

$\theta_{JC} = 55^{\circ} \text{C/W}$

MAX4426/MAX4427/MAX4428

Dual High-Speed 1.5A MOSFET Drivers

Revision History

REVISION NUMBER	REVISION DATE	DESCRIPTION	PAGES CHANGED
2	6/06	To clarify and illuminate an input logic level restriction	—



Maxim cannot assume responsibility for use of any circuitry other than circuitry entirely embodied in a Maxim product. No circuit patent licenses are implied. Maxim reserves the right to change the circuitry and specifications without notice at any time. The parametric values (min and max limits) shown in the Electrical Characteristics table are guaranteed. Other parametric values quoted in this data sheet are provided for guidance.

Maxim Integrated 160 Rio Robles, San Jose, CA 95134 USA 1-408-601-1000

7

Mouser Electronics

Authorized Distributor

Click to View Pricing, Inventory, Delivery & Lifecycle Information:

Maxim Integrated:

[MAX4426ESA+](#) [MAX4427CSA+](#) [MAX4427ESA+](#) [MAX4428EPA+](#) [MAX4428ESA+](#) [MAX4426MJA/883B](#)
[MAX4427MJA/883B](#) [MAX4428MJA/883B](#) [MAX4427ESA-T](#) [MAX4426CPA+](#) [MAX4426CSA+](#) [MAX4426CSA+T](#)
[MAX4426ESA+T](#) [MAX4427CPA+](#) [MAX4427CSA+T](#) [MAX4427EPA+](#) [MAX4427ESA](#) [MAX4427ESA+T](#)
[MAX4428CSA+](#) [MAX4428CSA+T](#) [MAX4428ESA+T](#) [MAX4428CPA+](#) [MAX4427CSA](#) [MAX4426CPA](#) [MAX4426ESA-T](#)
[MAX4427CSA-T](#) [MAX4428CPA](#) [MAX4428EPA](#) [MAX4428ESA](#) [MAX4428ESA-T](#) [MAX4426EPA](#) [MAX4426CSA](#)
[MAX4426CSA-T](#) [MAX4426ESA](#) [MAX4428CSA](#) [MAX4428CSA-T](#)