

1 Characteristics

Table 1. Absolute ratings (limiting values)

Symbol	Parameters		Value		Unit	
			TN805 TN815 TS820	TYN608		
$I_{T(RMS)}$	RMS on-state current On-state rms current (180° conduction angle)		$T_C = 110\text{ °C}$	8	A	
			TO-220FPAB, $T_C = 91\text{ °C}$			
$I_{T(AV)}$	Average on-state current (180° conduction angle)		$T_C = 110\text{ °C}$	5	A	
			TO-220FPAB, $T_C = 91\text{ °C}$			
I_{TSM}	Non repetitive surge peak on-state current	$t_p = 8.3\text{ ms}$	$T_j = 25\text{ °C}$	73	100	A
		$t_p = 10\text{ ms}$		70	95	
I^2t	I^2t value for fusing	$t_p = 10\text{ ms}$	$T_j = 25\text{ °C}$	24.5	45	A ² s
di/dt	Critical rate of rise of on-state current $I_G = 2 \times I_{GT}$, $t_r \leq 100\text{ ns}$	$F = 60\text{ Hz}$	$T_j = 125\text{ °C}$	50		A/ μ s
I_{GM}	Peak gate current	$t_p = 20\text{ }\mu$ s	$T_j = 125\text{ °C}$	4		A
$P_{G(AV)}$	Average gate power dissipation		$T_j = 125\text{ °C}$	1		W
T_{stg}	Storage junction temperature range			-40 to +150		°C
T_j	Operating junction temperature range			-40 to +125		°C
V_{RGM}	Maximum peak reverse gate voltage (for TN8x5 and TYN608 only)			5		V

Table 2. Sensitive electrical characteristics ($T_j = 25\text{ °C}$, unless otherwise specified)

Symbol	Parameter			TS820	Unit
I_{GT}	$V_D = 12\text{ V}$, $R_L = 140\text{ }\Omega$		Max.	200	μ A
V_{GT}			Max.	0.8	V
V_{RG}	$I_{RG} = 10\text{ }\mu$ A		Min.	8	V
V_{GD}	$V_D = V_{DRM}$, $R_L = 3.3\text{ k}\Omega$, $R_{GK} = 220\text{ }\Omega$	$T_j = 125\text{ °C}$	Min.	0.1	V
I_H	$I_T = 50\text{ mA}$, $R_{GK} = 1\text{ k}\Omega$		Max.	5	mA
I_L	$I_G = 1\text{ mA}$, $R_{GK} = 1\text{ k}\Omega$		Max.	6	mA
dV/dt	$V_D = 65\% V_{DRM}$, $R_{GK} = 220\text{ }\Omega$	$T_j = 125\text{ °C}$	Min.	5	V/ μ s
V_{TM}	$I_{TM} = 16\text{ A}$, $t_p = 380\text{ }\mu$ s	$T_j = 25\text{ °C}$	Max.	1.6	V
V_{T0}	Threshold voltage	$T_j = 125\text{ °C}$	Max.	0.85	V
R_d	Dynamic resistance	$T_j = 125\text{ °C}$	Max.	46	m Ω
I_{DRM} I_{RRM}	$V_{DRM} = V_{RRM}$, $R_{GK} = 220\text{ }\Omega$	$T_j = 25\text{ °C}$	Max.	5	μ A
		$T_j = 125\text{ °C}$		1	mA

Table 3. Standard electrical characteristics ($T_j = 25\text{ °C}$, unless otherwise specified)

Symbol	Parameter		TN805	TN815	TYN608	Unit
I_{GT}	$V_D = 12\text{ V}$, $R_L = 140\ \Omega$	Min.	0.5	2	2	mA
		Max.	5	15	15	
V_{GT}		Max.	1.3			V
V_{GD}	$V_D = V_{DRM}$, $R_L = 3.3\text{ k}\Omega$	$T_j = 125\text{ °C}$ Min.	0.2			V
I_H	$I_T = 100\text{ mA}$, gate open	Max.	25	40	30	mA
I_L	$I_G = 1.2 I_{GT}$	Max.	30	50	70	mA
dV/dt	$V_D = 67\% V_{DRM}$, gate open	$T_j = 125\text{ °C}$ Min.	50	150	150	V/ μ s
V_{TM}	$I_{TM} = 16\text{ A}$, $t_p = 380\ \mu$ s	$T_j = 25\text{ °C}$ Max.	1.6			V
V_{t0}	Threshold voltage	$T_j = 125\text{ °C}$ Max.	0.85			V
R_d	Dynamic resistance	$T_j = 125\text{ °C}$ Max.	46			m Ω
I_{DRM} I_{RRM}	$V_{DRM} = V_{RRM}$	$T_j = 25\text{ °C}$ Max.	5			μ A
		$T_j = 125\text{ °C}$ Max.	2			mA

Table 4. Thermal resistance (maximum values)

Symbol	Parameter		Value	Unit	
$R_{th(j-c)}$	Junction to case (DC)	IPAK / DPAK / TO-220AB	1.3	$^{\circ}\text{C/W}$	
		TO-220FPAB	4.6		
$R_{th(j-a)}$	Junction to ambient	$S^{(1)} = 0.5\text{ cm}^2$	DPAK	70	$^{\circ}\text{C/W}$
	Junction to ambient		TO-220AB / TO-220FPAB	60	
			IPAK	100	

1. S = Copper surface under tab

1.1 Characteristics curves
Figure 1. Maximum average power dissipation versus average on-state current

Figure 2. Average and DC on-state current versus case temperature

Figure 3. Average and DC on-state current versus ambient temperature

Figure 4. Relative variation of thermal impedance junction to case versus pulse duration

Figure 5. Relative variation of thermal impedance junction to ambient versus pulse duration

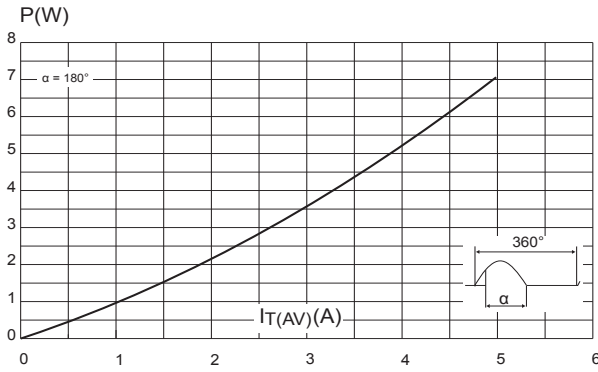
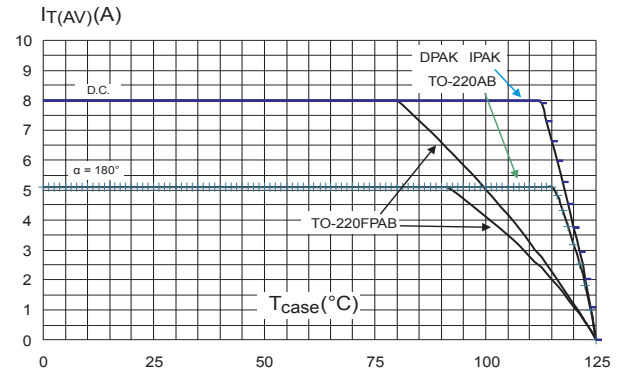
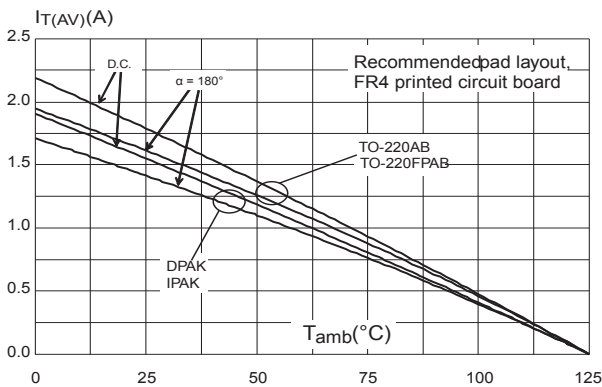
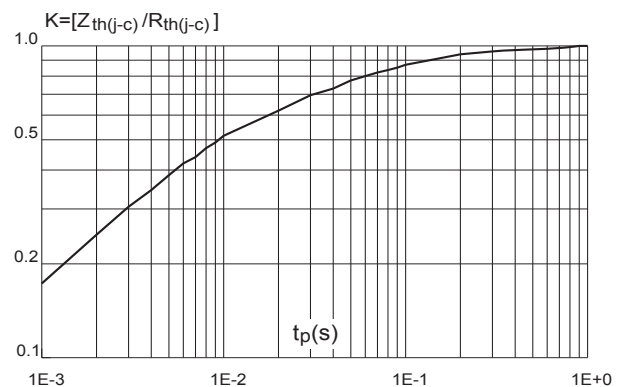
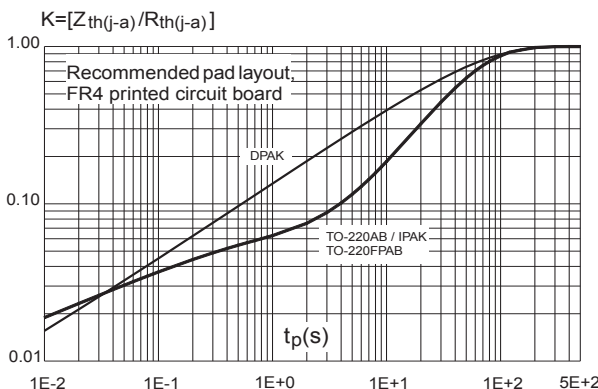
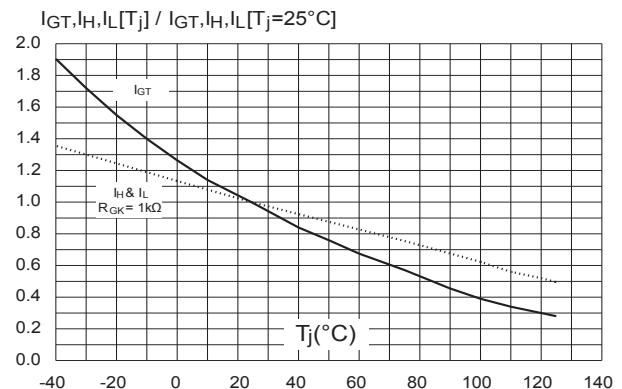
Figure 6. Relative variation of gate trigger current and holding current versus junction temperature for TS820

Figure 7. Relative variation of gate trigger current and holding current versus junction temperature

Figure 8. Relative variation of holding current versus gate-cathode resistance (typical values)

Figure 9. Relative variation of dV/dt immunity versus gate-cathode resistance (typical values) for TS820

Figure 10. Relative variation of dV/dt immunity versus gate-cathode capacitance (typical values) for TS820

Figure 11. Surge peak on-state current versus number of cycles

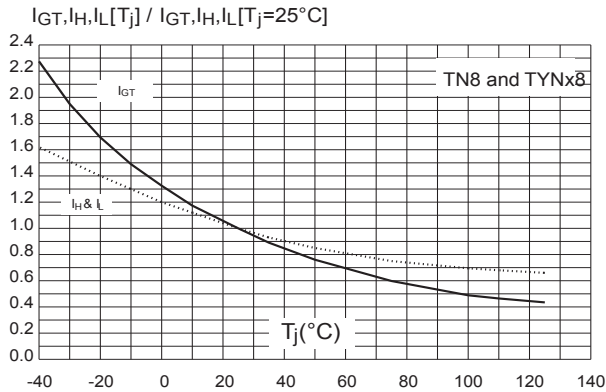
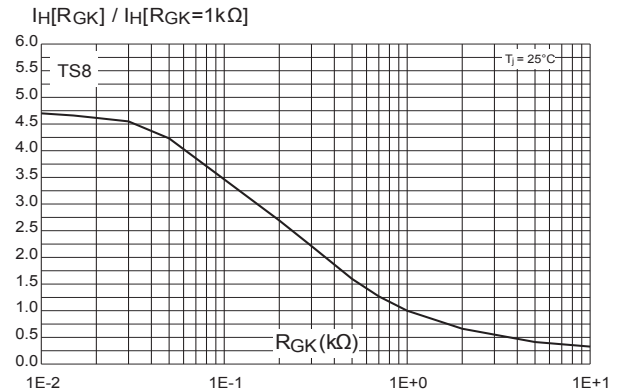
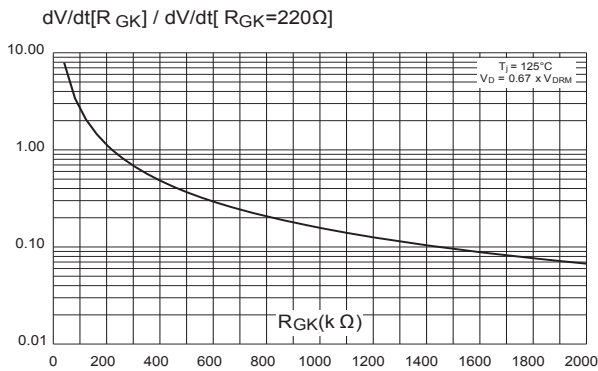
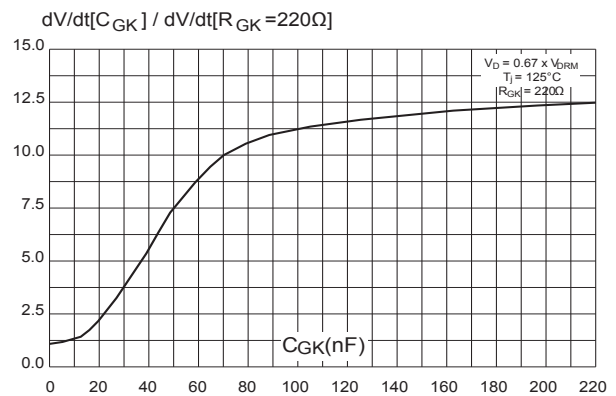
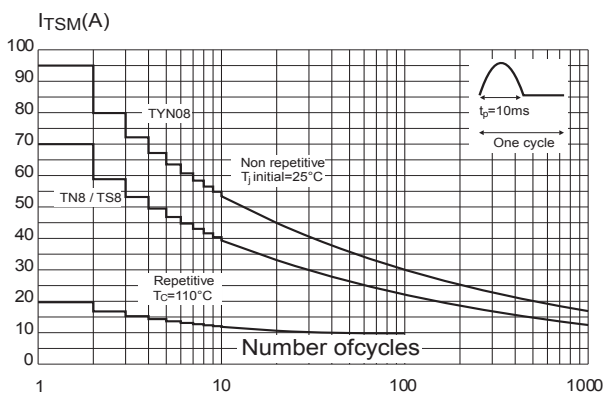
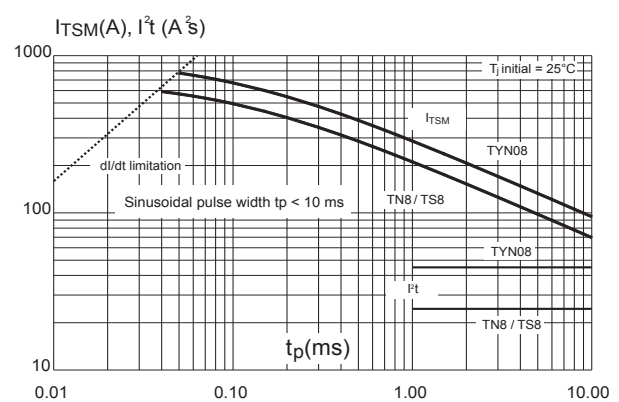
Figure 12. Non-repetitive surge peak on-state current and corresponding values of I2t

Figure 13. On-state characteristics (maximum values)

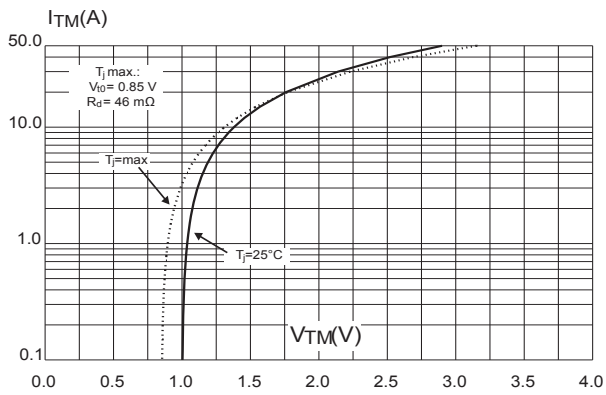
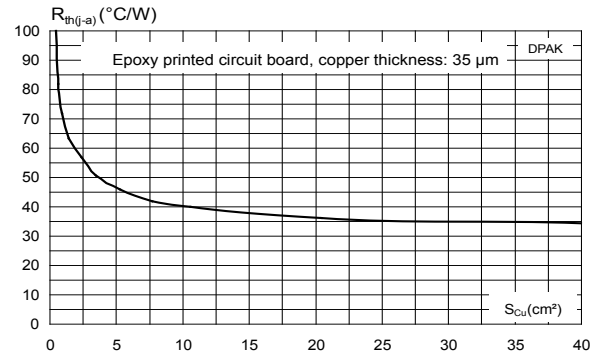

Figure 14. Thermal resistance junction to ambient versus copper surface under tab



2 Package information

In order to meet environmental requirements, ST offers these devices in different grades of **ECOPACK** packages, depending on their level of environmental compliance. ECOPACK specifications, grade definitions and product status are available at: www.st.com. ECOPACK is an ST trademark.

2.1 DPAK package information

- Molding compounded resin is halogen free and meets UL94 flammability standard, level V0
- Lead-free package leads plating

Figure 15. DPAK package outline

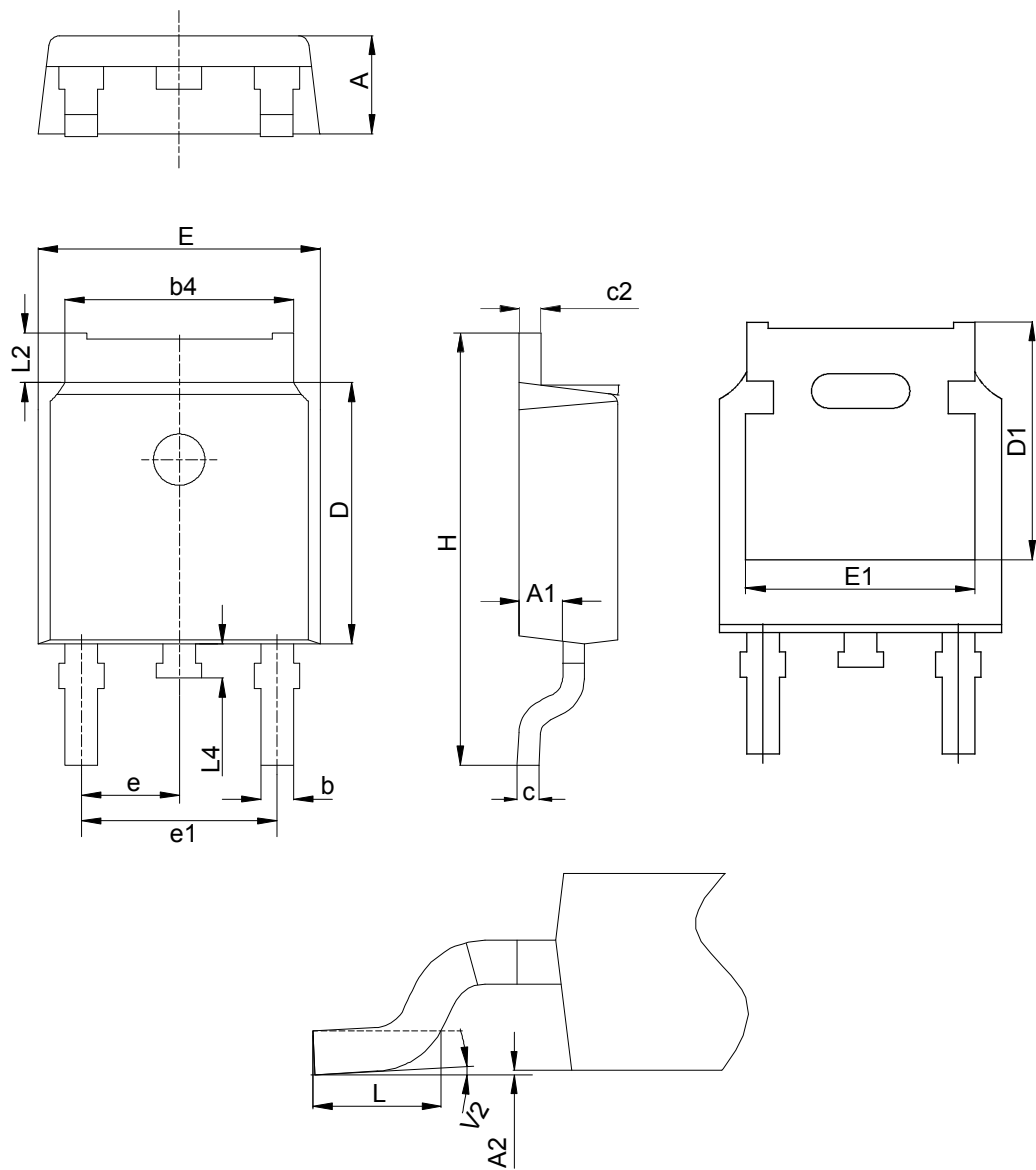

Table 5. DPAK package mechanical data

Ref.	Dimensions					
	Millimeters			Inches ⁽¹⁾		
	Min.	Typ.	Max.	Min.	Typ.	Max.
A	2.18		2.40	0.0858		0.0945
A1	0.90		1.10	0.0354		0.0433
A2	0.03		0.23	0.0012		0.0091
b	0.64		0.90	0.0252		0.354
b4	4.95		5.46	0.1949		0.2150
c	0.46		0.61	0.0181		0.0240
c2	0.46		0.60	0.0181		0.0236
D	5.97		6.22	0.2350		0.2449
D1	4.95		5.60	0.1949		0.2205
E	6.35		6.73	0.2500		0.2650
E1	4.32		5.50	0.1701		0.2165
e		2.286			0.0900	
e1	4.40		4.70	0.1732		0.1850
H	9.35		10.40	0.3681		0.4094
L	1.00		1.78	0.0394		0.0701
L2			1.27			0.0500
L4	0.60		1.02	0.0236		0.0402
V2 ⁽²⁾	-8°		+8°	-8°		+8°

1. Dimensions in inches are given for reference only

2. Degree

Note: This package drawing may slightly differ from the physical package. However, all the specified dimensions are guaranteed.

Figure 16. DPAK recommended footprint (dimensions are in mm)

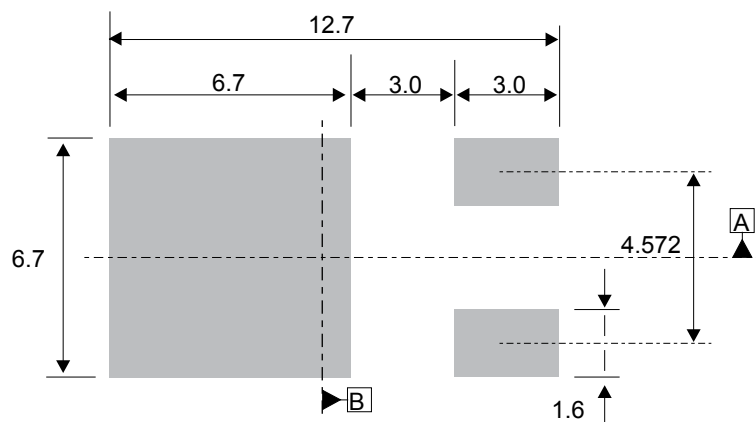

The device must be positioned within $\oplus 0.05$ AB

2.2 IPAK package information

- Molding compounded resin is halogen free and meets UL94 flammability standard, level V0
- Lead-free package leads plating

Figure 17. IPAK package outline

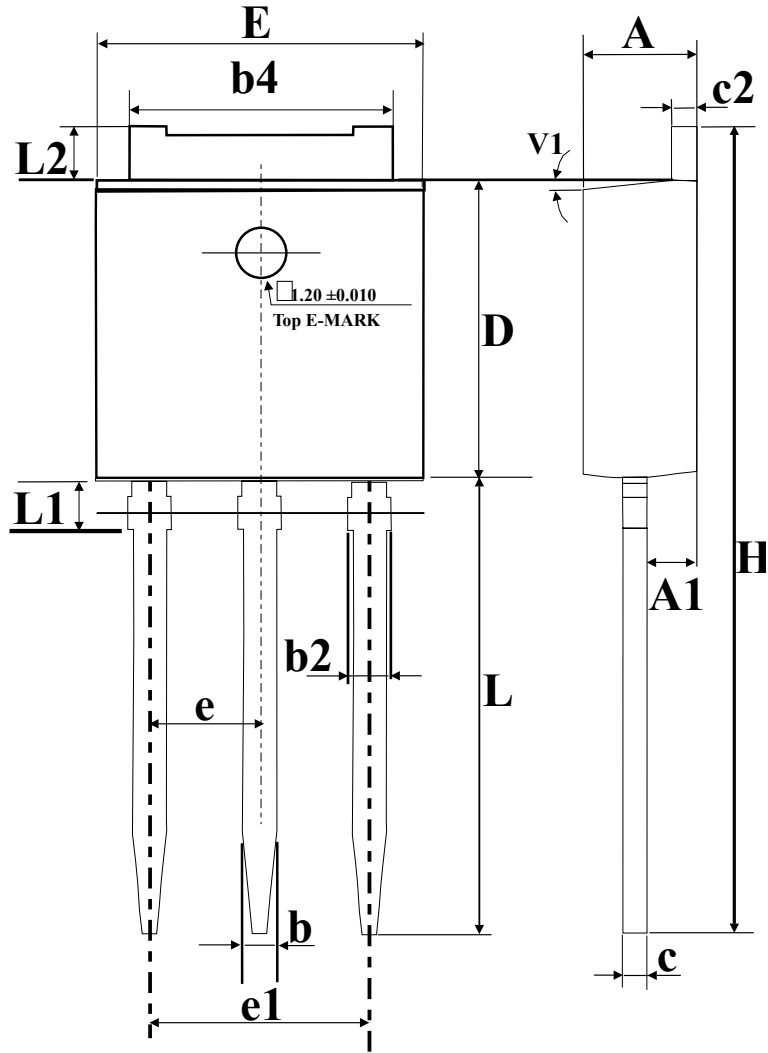

Table 6. IPAK package mechanical data

Ref.	Dimensions					
	MillimetersInches (for reference only)					
	Min.	Typ.	Max.	Min.	Typ.	Max.
A	2.20		2.40	0.086		0.094
A1	0.90		1.10			0.035
b	0.64		0.90	0.025		0.035
b2			0.95			0.037
b4	5.20		5.43			
c	0.45		0.60			
c2	0.46		0.60			
D	6		6.20			
E	6.40		6.70	0.252		0.263
e		2.28			0.090	
e1	4.40		4.60	0.173		0.181
H		16.10			0.634	
L	9		9.60	0.354		0.377
L1	0.8		1.20	0.031		0.047
L2		0.80	1.25		0.031	0.049
V1	10°				10°	

Table 7. TO-220AB package mechanical data

Ref.	Dimensions			
	Millimeters		Inches (for reference only)	
	Min.	Max.	Min.	Max.
A	4.40	4.60	0.173	0.181
b	0.61	0.88	0.240	0.035
b1	1.14	1.55	0.045	0.061
c	0.48	0.70	0.019	0.028
D	15.25	15.75	0.600	0.620
D1	1.27 typ.		0.050 typ.	
E	10.00	10.40	0.394	0.409
e	2.40	2.70	0.094	0.106
e1	4.95	5.15	0.195	0.203
F	1.23	1.32	0.048	0.052
H1	6.20	6.60	0.244	0.260
J1	2.40	2.72	0.094	0.107
L	13.00	14.00	0.512	0.551
L1	3.50	3.93	0.138	0.155
L20	16.40 typ.		0.646 typ.	
L30	28.90 typ.		1.138 typ.	
θP	3.75	3.85	0.148	0.152
Q	2.65	2.95	0.104	0.116

2.4 TO-220AB package information

- Molding compound resin is halogen free and meets UL94 flammability standard, level V0
- Lead-free plating package leads
- Recommended torque: 0.4 to 0.6 N·m

Figure 19. TO-220AB package outline

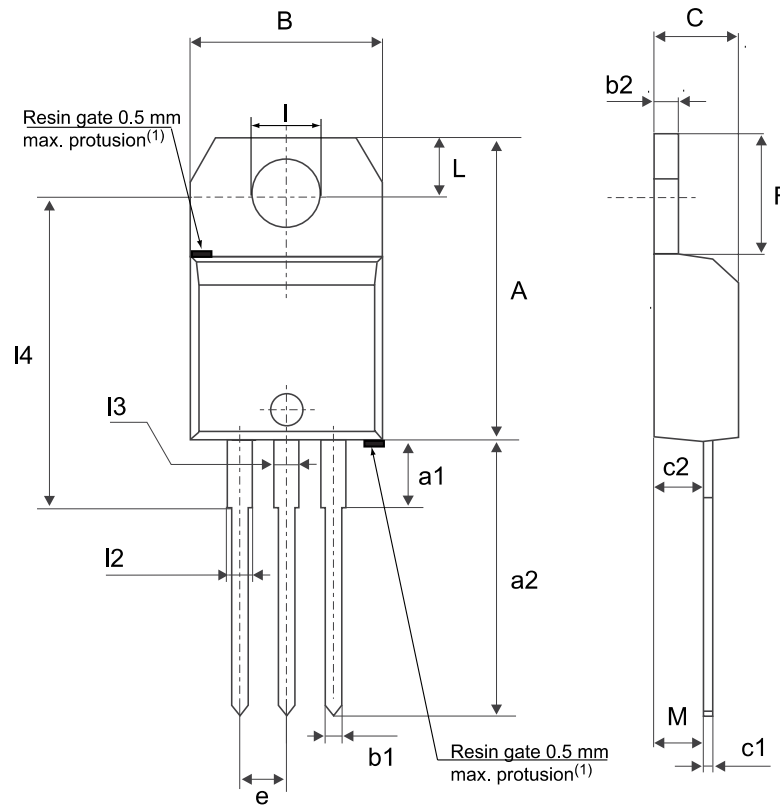

(1) Resin gate position accepted in one of the two positions or in the symmetrical opposites.

Table 8. TO-220AB package mechanical data

Ref.	Dimensions					
	Millimeters			Inches ⁽¹⁾		
	Min.	Typ.	Max.	Min.	Typ.	Max.
A	15.20		15.90	0.5984		0.6260
a1		3.75			0.1476	
a2	13.00		14.00	0.5118		0.5512
B	10.00		10.40	0.3937		0.4094
b1	0.61		0.88	0.0240		0.0346
b2	1.23		1.32	0.0484		0.0520
C	4.40		4.60	0.1732		0.1811
c1	0.49		0.70	0.0193		0.0276
c2	2.40		2.72	0.0945		0.1071
e	2.40		2.70	0.0945		0.1063
F	6.20		6.60	0.2441		0.2598
I	3.73		3.88	0.1469		0.1528
L	2.65		2.95	0.1043		0.1161
I2	1.14		1.70	0.0449		0.0669
I3	1.14		1.70	0.0449		0.0669
I4	15.80	16.40	16.80	0.6220	0.6457	0.6614
M		2.6			0.1024	

1. Inch dimensions are for reference only.

2.5 TO-220FPAB package information

- Epoxy meets UL94, V0
- Recommended torque: 0.4 to 0.6 N·m

Figure 20. TO-220FPAB package outline

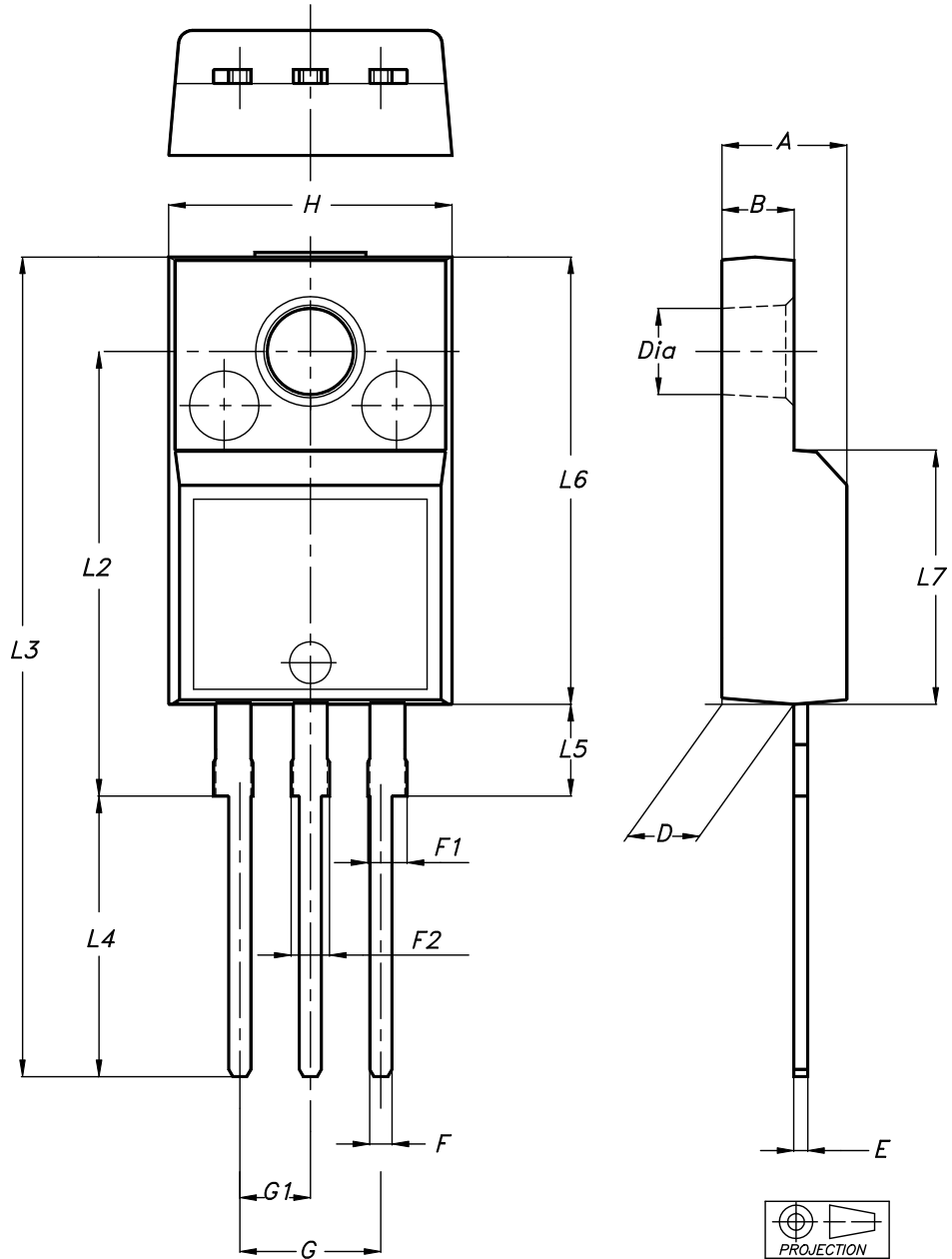

Table 9. TO-220FPAB package mechanical data

Ref.	Dimensions			
	Millimeters		Inches	
	Min.	Max.	Min.	Max.
A	4.40	4.60	0.1739	0.1818
B	2.5	2.7	0.0988	0.1067
D	2.50	2.75	0.0988	0.1087
E	0.45	0.70	0.0178	0.0277
F	0.75	1.0	0.0296	0.0395
F1	1.15	1.70	0.0455	0.0672
F2	1.15	1.70	0.0455	0.0672
G	4.95	5.20	0.1957	0.2055
G1	2.40	2.70	0.0949	0.1067
H	10.00	10.40	0.3953	0.4111
L2	16.00 typ.		0.6324 typ.	
L3	28.60	30.60	1.1304	1.2095
L4	9.80	10.6	0.3874	0.4190
L5	2.90	3.60	0.1146	0.1423
L6	15.90	16.40	0.6285	0.6482
L7	9.00	9.30	0.3557	0.3676
Dia	3.0	3.20	0.1186	0.1265

3 Ordering information

Figure 21. TN8 series

Figure 22. TS8 series

Figure 23. TYNx08 series

Table 10. Ordering information

Order code	Marking	Package	Weight	Base qty	Delivery mode
TN805-600B-TR	TN805600	DPAK	0.3 g	2500	Tape and reel
TN815-600B-TR	TN815600	DPAK	0.3 g	2500	Tape and reel
TN815-800B-TR	TN815800	DPAK	0.3 g	2500	Tape and reel
TN815-800H	TN815800	IPAK	0.4 g	75	Tube
TS820-600B	TS820600	DPAK	0.3 g	75	Tube
TS820-600B-TR	TS820600	DPAK	0.3 g	2500	Tape and reel
TS820-600H	TS820600	IPAK	0.4 g	75	Tube
TS820-600T	TS820600T	TO-220AB	2.3 g	50	Tube
TS820-600FP	TS820600	TO-220FPAB	2.0 g	50	Tube
TYN608RG	TYN608	TO-220AB	2.3 g	50	Tube

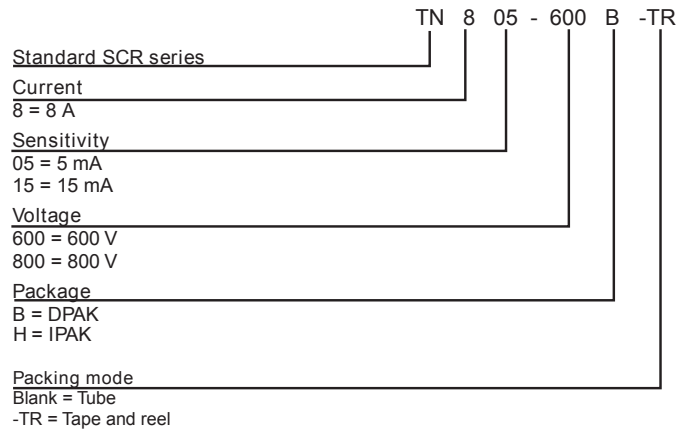
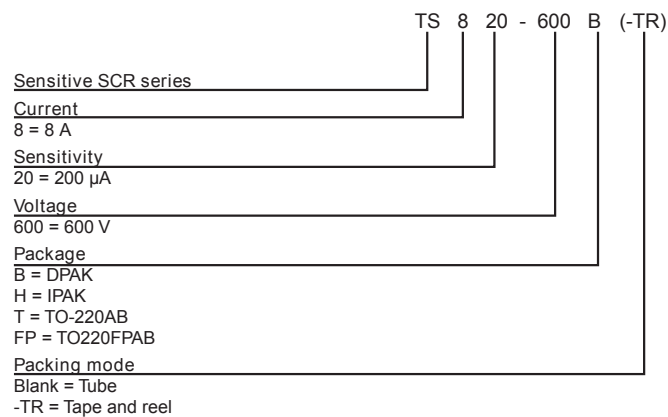
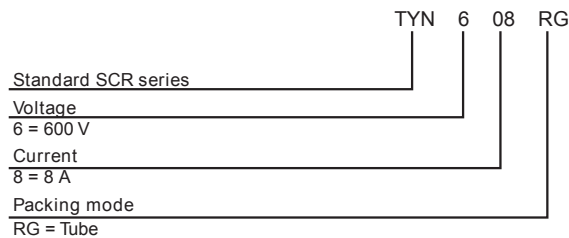
Revision history

Table 11. Document revision history

Date	Revision	Changes
Apr-2002	4A	Last update.
13-Feb-2006	5	TO-220AB delivery mode changed from bulk to tube. ECOPACK statement added.
22-Jan-2010	6	Alpha definition updated in Figure 1. Thermal resistance, junction to case, updated in Table 5.
10-Oct-2011	7	Added TO-220FPAB package. Removed 700 V and 1000 V products.
14-May-2014	8	Updated DPAK and IPAK package information and reformatted to current standard.
03-Nov-2021	9	Added TN815-800H product information. Minor text changes.

IMPORTANT NOTICE – PLEASE READ CAREFULLY

STMicroelectronics NV and its subsidiaries (“ST”) reserve the right to make changes, corrections, enhancements, modifications, and improvements to ST products and/or to this document at any time without notice. Purchasers should obtain the latest relevant information on ST products before placing orders. ST products are sold pursuant to ST’s terms and conditions of sale in place at the time of order acknowledgement.

Purchasers are solely responsible for the choice, selection, and use of ST products and ST assumes no liability for application assistance or the design of Purchasers’ products.

No license, express or implied, to any intellectual property right is granted by ST herein.

Resale of ST products with provisions different from the information set forth herein shall void any warranty granted by ST for such product.

ST and the ST logo are trademarks of ST. For additional information about ST trademarks, please refer to www.st.com/trademarks. All other product or service names are the property of their respective owners.

Information in this document supersedes and replaces information previously supplied in any prior versions of this document.

© 2021 STMicroelectronics – All rights reserved

Mouser Electronics

Authorized Distributor

Click to View Pricing, Inventory, Delivery & Lifecycle Information:

STMicroelectronics:

[TS820-600B](#) [TS820-600H](#) [TS820-600T](#) [TS820-600B-TR](#) [TN815-600B-TR](#) [TYN608RG](#) [TN805-600B-TR](#) [TN815-800B-TR](#) [TS820-600FP](#)