

**TABLE OF CONTENTS**

Specifications.....	3	Mobile Handset Power Control Example .....	15
Absolute Maximum Ratings.....	5	Power-On and Power-Off .....	16
ESD Caution.....	5	Input Coupling Options .....	16
Pin Configuration and Function Descriptions.....	6	Temperature Drift .....	17
Typical Performance Characteristics .....	7	Device Calibration and Error Calculation.....	17
Theory of Operation .....	11	Selecting Calibration Points to Improve Accuracy over a Reduced Range .....	18
Basic Theory.....	11	Device Handling.....	19
Controller-Mode Log Amps .....	12	Evaluation Board .....	20
Control Loop Dynamics .....	12	Outline Dimensions .....	22
Basic Connections .....	14	Ordering Guide .....	22
Range on VSET and RFIN.....	14		
Transient Response.....	15		

**REVISION HISTORY****1/11—Rev. 0 to Rev. A**

Updated Outline Dimensions .....	22
Changes to Ordering Guide .....	22

**6/05—Revision 0: Initial Version**

## SPECIFICATIONS

VPOS = 2.7 V, Frequency = 0.1 GHz,  $T_A = 25^\circ\text{C}$ , 52.3  $\Omega$  termination on RFIN, light condition = 600 lux, unless otherwise noted.

Table 1.

Parameter	Conditions	Min	Typ	Max	Unit
SPECIFIED FREQUENCY RANGE	RFIN (Pin 6)	0.1		2.5	GHz
MEASUREMENT MODE <sup>1</sup> (f = 0.1 GHz)					
Input Impedance	No termination resistor on RFIN		2140    1.97		$\Omega$    pF
$\pm 1$ dB Dynamic Range	$T_A = +25^\circ\text{C}$ $-40^\circ\text{C} < T_A < +85^\circ\text{C}$		47		dB
Maximum Input Level	$\pm 1$ dB error	+2	+2.6		dBm
Minimum Input Level	$\pm 1$ dB error		-44.5	-44	dBm
Slope <sup>2</sup>		21.5	23.8	25.5	mV/dB
Intercept <sup>2</sup>		-66	-58.9	-51	dBm
VSET Voltage—High Power In	$P_{IN} = -10$ dBm		1.16		V
VSET Voltage—Low Power In	$P_{IN} = -40$ dBm		0.45		V
Temperature Sensitivity	$P_{IN} = -10$ dBm $25^\circ\text{C} \leq T_A \leq +85^\circ\text{C}$ $-40^\circ\text{C} \leq T_A \leq +25^\circ\text{C}$		-0.0020		dB/ $^\circ\text{C}$
			+0.0121		dB/ $^\circ\text{C}$
MEASUREMENT MODE (f = 0.9 GHz)					
Input Impedance	No termination resistor on RFIN		370    1.58		$\Omega$    pF
$\pm 1$ dB Dynamic Range	$T_A = +25^\circ\text{C}$ $-40^\circ\text{C} < T_A < +85^\circ\text{C}$		51		dB
Maximum Input Level	$\pm 1$ dB error		+2.8		dBm
Minimum Input Level	$\pm 1$ dB error		-47.9		dBm
Slope <sup>2</sup>			23.6		mV/dB
Intercept <sup>2</sup>			-59.7		dBm
VSET Voltage—High Power In	$P_{IN} = -10$ dBm		1.17		V
VSET Voltage—Low Power In	$P_{IN} = -40$ dBm		0.46		V
Temperature Sensitivity	$P_{IN} = -10$ dBm $25^\circ\text{C} \leq T_A \leq +85^\circ\text{C}$ $-40^\circ\text{C} \leq T_A \leq +25^\circ\text{C}$		0.0015		dB/ $^\circ\text{C}$
			0.0094		dB/ $^\circ\text{C}$
MEASUREMENT MODE (f = 1.9 GHz)					
Input Impedance	No termination resistor on RFIN		180    1.67		$\Omega$    pF
$\pm 1$ dB Dynamic Range	$T_A = +25^\circ\text{C}$ $-40^\circ\text{C} < T_A < +85^\circ\text{C}$		42		dB
Maximum Input Level	$\pm 1$ dB error		41		dB
Minimum Input Level	$\pm 1$ dB error		-5.6		dBm
Slope <sup>2</sup>			-48.0		dBm
Intercept <sup>2</sup>			22.7		mV/dB
VSET Voltage—High Power In	$P_{IN} = -10$ dBm		-60.8		dBm
VSET Voltage—Low Power In	$P_{IN} = -40$ dBm		1.15		V
Temperature Sensitivity	$P_{IN} = -40$ dBm $P_{IN} = -10$ dBm $25^\circ\text{C} \leq T_A \leq +85^\circ\text{C}$ $-40^\circ\text{C} \leq T_A \leq +25^\circ\text{C}$		0.47		V
			0.0056		dB/ $^\circ\text{C}$
			0.0077		dB/ $^\circ\text{C}$

# AD8311

Parameter	Conditions	Min	Typ	Max	Unit
<b>MEASUREMENT MODE (f = 2.5 GHz)</b>					
Input Impedance	No termination resistor on RFIN		164    1.55		$\Omega$    pF
$\pm 1$ dB Dynamic Range	$T_A = +25^\circ\text{C}$		42		dB
	$-40^\circ\text{C} < T_A < +85^\circ\text{C}$		41		dB
Maximum Input Level	$\pm 1$ dB error		-6.2		dBm
Minimum Input Level	$\pm 1$ dB error		-47.7		dBm
Slope <sup>2</sup>			22.5		mV/dB
Intercept <sup>2</sup>			-60.6		dBm
VSET Voltage—High Power In	$P_{IN} = -10$ dBm		1.14		V
VSET Voltage—Low Power In	$P_{IN} = -40$ dBm		0.46		V
Temperature Sensitivity	$P_{IN} = -10$ dBm				
	$25^\circ\text{C} \leq T_A \leq 85^\circ\text{C}$		-0.0004		dB/°C
	$-40^\circ\text{C} \leq T_A \leq +25^\circ\text{C}$		+0.0090		dB/°C
<b>OUTPUT INTERFACE</b>					
Minimum Output Voltage	VAPC (Pin 2) $V_{SET} \leq 150\text{mV}$	0.2	0.3	0.4	V
Maximum Output Voltage	$I_{OUT} = 3$ mA	2.3		2.55	V
	$R_L = \infty$	2.4		2.65	V
vs. Temperature	$85^\circ\text{C}$ , $V_{POS} = 3$ V, $I_{OUT} = 6$ mA	2.54			V
General Limit	$2.7\text{ V} \leq V_{POS} \leq 5.5\text{ V}$ , $R_L = \infty$		VPOS - 0.1		V
Output Current Drive	$V_{SET} = 1.5$ V, RFIN = -50 dBm, source/sink		5/200		mA/ $\mu$ A
Output Noise	RF Input = 2 GHz, 0 dBm, $f_{NOISE} = 100$ kHz, $C_{FLT} = 220$ pF		170		nV/ $\sqrt{\text{Hz}}$
Small Signal Bandwidth	RFIN = -10 dBm; from FLTR to VAPC		30		MHz
Fall Time	Input level = off to 0 dBm, 90% to 10%		120		ns
Rise Time	Input level = 0 dBm to off, 10% to 90%		270		ns
Slew Rate	90% - 10%, $V_{SET} = 0.3$ V, open loop		15		V/ $\mu$ s
Response Time	FLTR = Open		130		ns
<b>VSET INTERFACE</b>					
VSET (Pin 3)					
Nominal Input Range	RFIN = 0 dBm; measurement mode		1.4		V
	RFIN = -50 dBm; measurement mode		0.27		V
Logarithmic Scale Factor			0.04		dB/mV
Bias Current Source	RFIN = -10 dBm; $V_{SET} = 1.4$ V		0.26		$\mu$ A
Input Resistance			36		M $\Omega$
Slew Rate			14		V/ $\mu$ s
<b>POWER INTERFACE</b>					
VPOS (Pin 1)					
Supply Voltage		2.7		5.5	V
Quiescent Current		5	7.6	10.7	mA
	$-40^\circ\text{C} \leq T_A \leq +85^\circ\text{C}$		8.2	12.9	mA
Power-On Time	Time from VPOS high to $V_{APC}$ within 1% of final value, $V_{SET} \leq 200$ mV		3	10	$\mu$ s
Power-Off Time	Time from VPOS low to $V_{APC}$ within 1% of final value, $V_{SET} \leq 200$ mV		100	2000	ns

<sup>1</sup> VAPC (Pin 2) to VSET (Pin 3) with inversion stage, sinusoidal input signal.

<sup>2</sup> Mean and standard deviation specifications are available in Table 4.

## ABSOLUTE MAXIMUM RATINGS

Table 2.

Parameters	Ratings
Supply Voltage VPOS	5.5 V
VAPC, VSET	0 V, VPOS
RFIN	17 dBm
Equivalent Voltage	1.6 V rms
Internal Power Dissipation	60 mW
$\theta_{JA}$ (WLCSP)	200°C/W
Maximum Junction Temperature	125°C
Operating Temperature Range	-40°C to +85°C
Storage Temperature Range	-65°C to +150°C

Stresses above those listed under Absolute Maximum Ratings may cause permanent damage to the device. This is a stress rating only; functional operation of the device at these or any other conditions above those indicated in the operational section of this specification is not implied. Exposure to absolute maximum rating conditions for extended periods may affect device reliability.

### ESD CAUTION



**ESD (electrostatic discharge) sensitive device.** Charged devices and circuit boards can discharge without detection. Although this product features patented or proprietary protection circuitry, damage may occur on devices subjected to high energy ESD. Therefore, proper ESD precautions should be taken to avoid performance degradation or loss of functionality.

## PIN CONFIGURATION AND FUNCTION DESCRIPTIONS

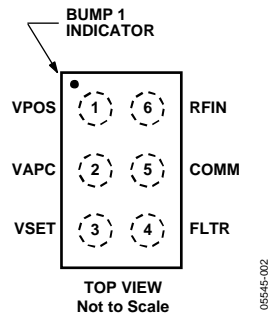

Figure 2. Pin Configuration

Table 3. Pin Function Descriptions

Pin No.	Mnemonic	Function
1	VPOS	Positive Supply Voltage: 2.7 V to 5.5 V.
2	VAPC	Output. Control voltage for gain control element.
3	VSET	Setpoint Input. Nominal input range 0.25 V to 1.4 V.
4	FLTR	Integrator Capacitor. Connect between FLTR and COMM.
5	COMM	Device Common (Ground).
6	RFIN	RF Input.

# TYPICAL PERFORMANCE CHARACTERISTICS

VPOS = 2.7 V; T<sub>A</sub> = 25°C; C<sub>FLT</sub> = open; light condition = 600 lux, 52.3 Ω termination; unless otherwise noted. Colors: +25°C = black, -40°C = blue, +85°C = red.

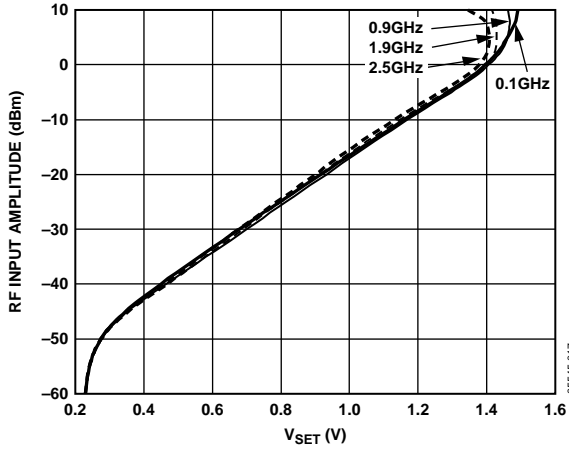

Figure 3. Input Amplitude vs. V<sub>SET</sub>

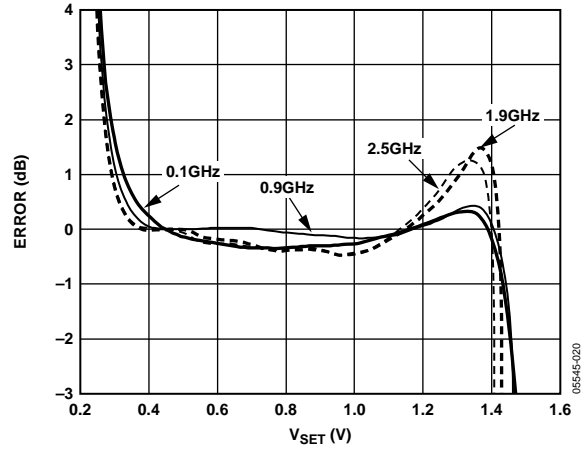

Figure 6. Log Conformance vs. V<sub>SET</sub>

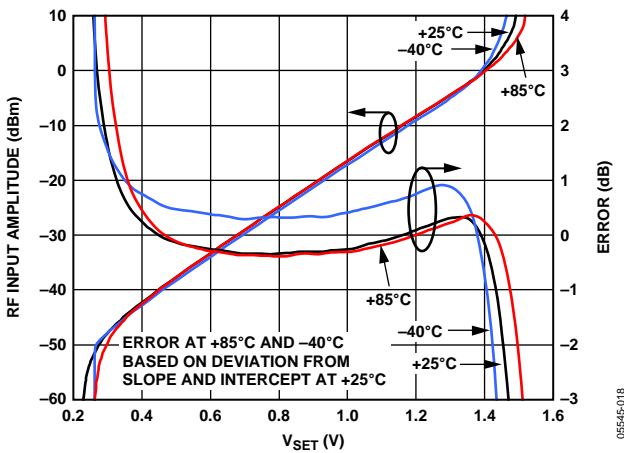

Figure 4. Input Amplitude and Log Conformance vs. V<sub>SET</sub> at 0.1 GHz -40°C, +25°C, and +85°C

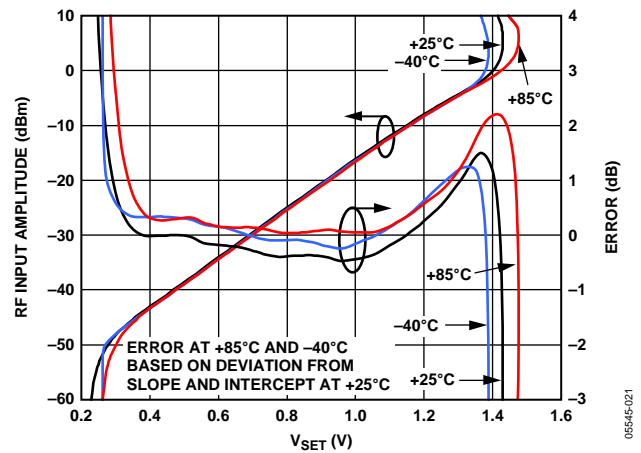

Figure 7. Input Amplitude and Log Conformance vs. V<sub>SET</sub> at 1.9 GHz -40°C, +25°C, and +85°C

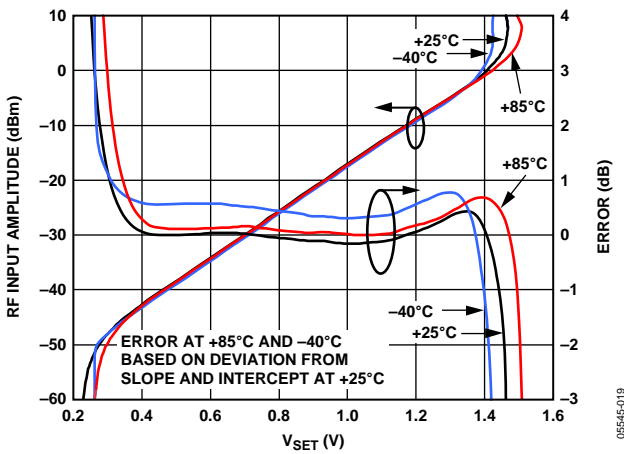

Figure 5. Input Amplitude and Log Conformance vs. V<sub>SET</sub> at 0.9 GHz -40°C, +25°C, and +85°C

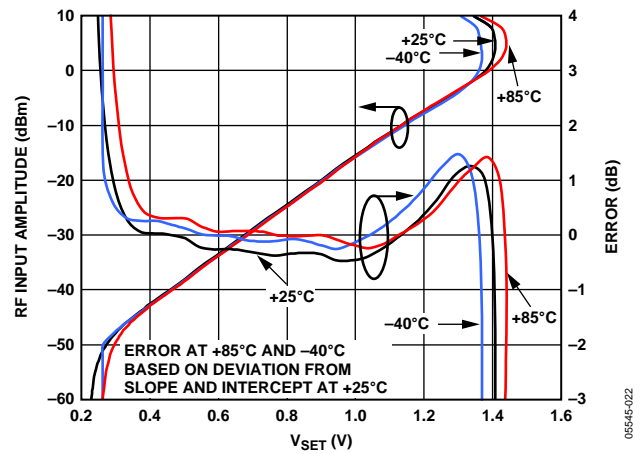

Figure 8. Input Amplitude and Log Conformance vs. V<sub>SET</sub> at 2.5 GHz -40°C, +25°C, and +85°C

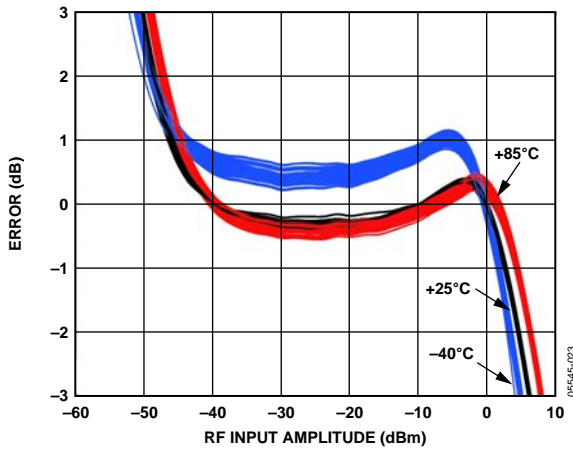

Figure 9. Distribution of Error over Temperature After Ambient Normalization vs. Input Amplitude at 0.1 GHz

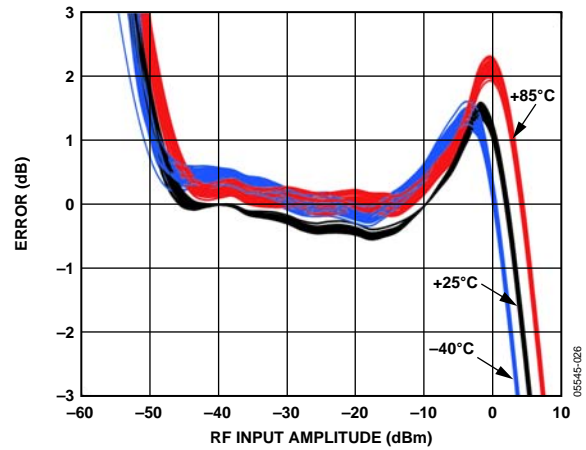

Figure 12. Distribution of Error over Temperature After Ambient Normalization vs. Input Amplitude at 1.9 GHz

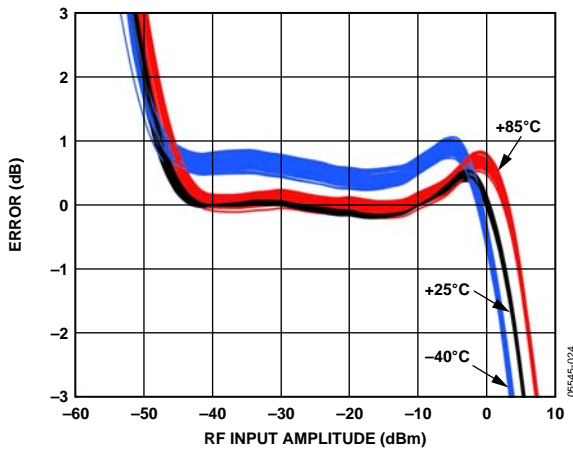

Figure 10. Distribution of Error over Temperature after Ambient Normalization vs. Input Amplitude at 0.9 GHz

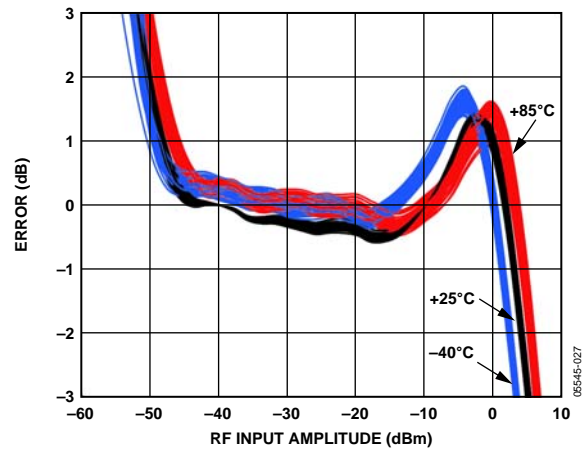

Figure 13. Distribution of Error over Temperature after Ambient Normalization vs. Input Amplitude at 2.5 GHz

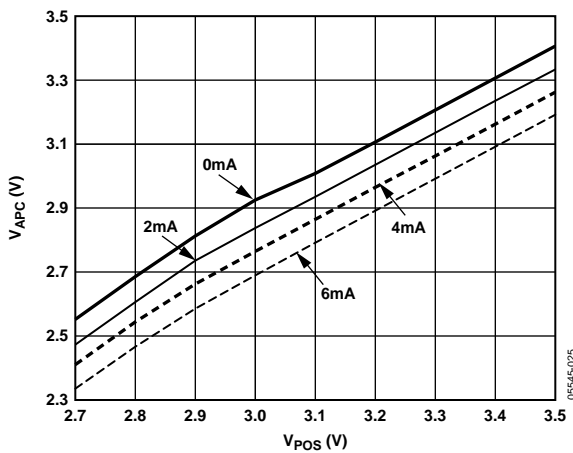
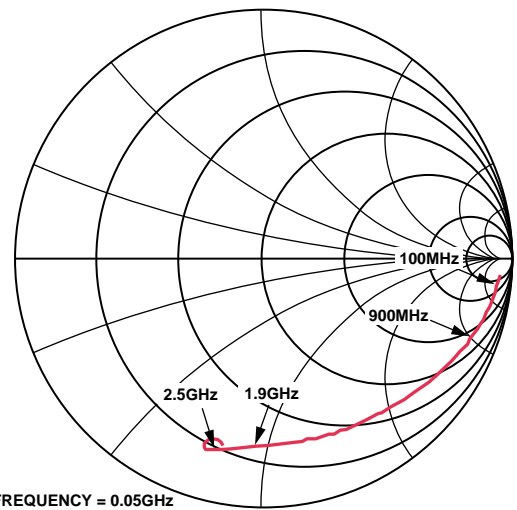

Figure 11. Maximum  $V_{APC}$  Voltage vs. Supply Voltage by Load Current



START FREQUENCY = 0.05GHz  
STOP FREQUENCY = 3.5GHz

Figure 14. Input Impedance vs. Frequency, No Termination Resistor on RFIN

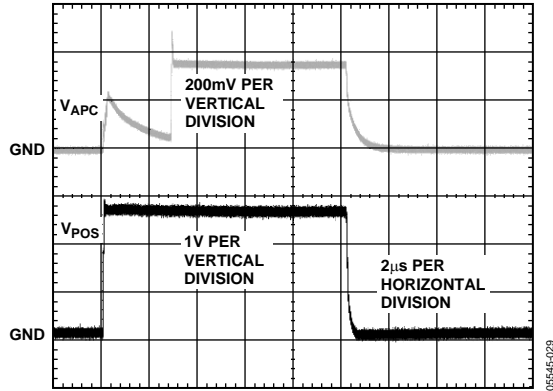

Figure 15. Power-On and -Off Response with VSET Grounded

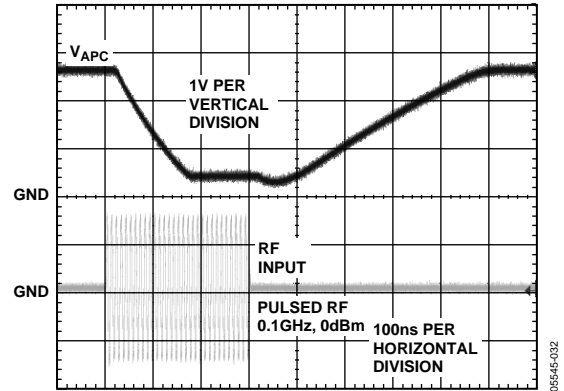

Figure 18.  $V_{APC}$  Response Time, Full-Scale Amplitude Change, Open-Loop

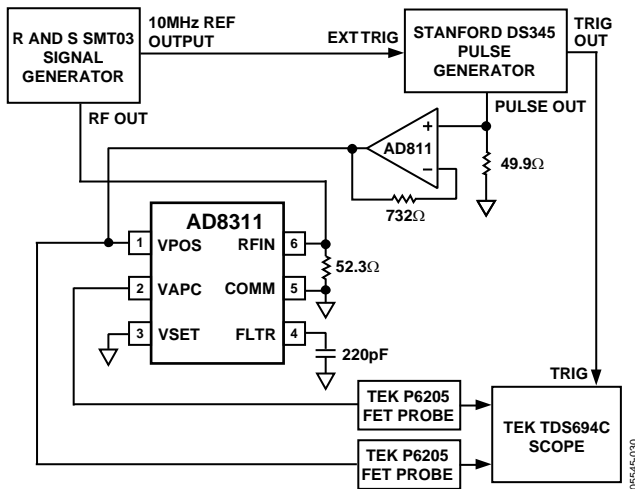

Figure 16. Test Setup for Power-On and -Off Response with VSET Grounded

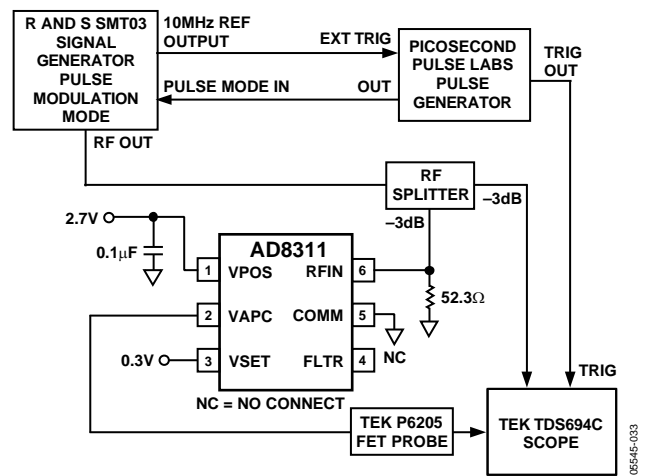

Figure 19. Test Setup for  $V_{APC}$  Response Time

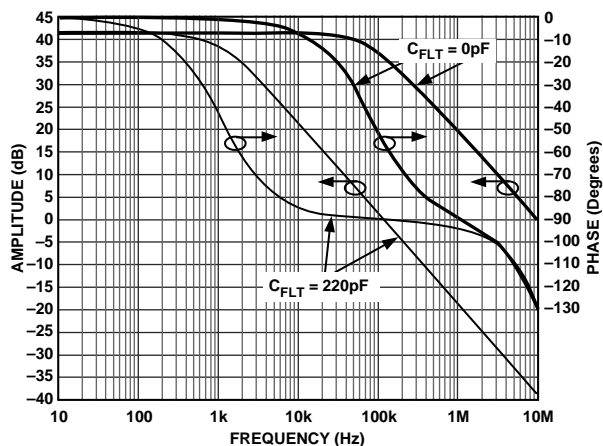

Figure 17. AC Response from VSET to  $V_{APC}$

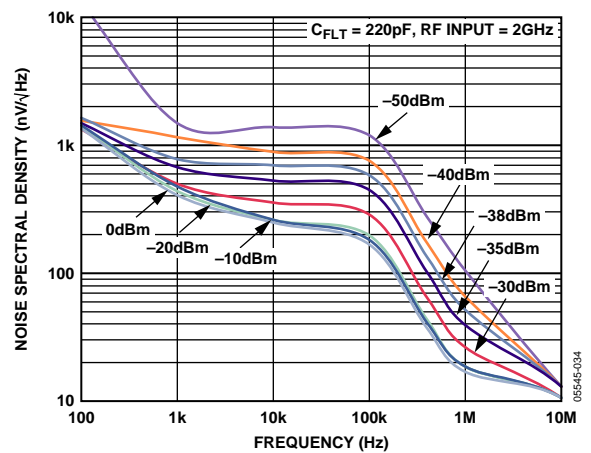

Figure 20.  $V_{APC}$  Noise Spectral Density



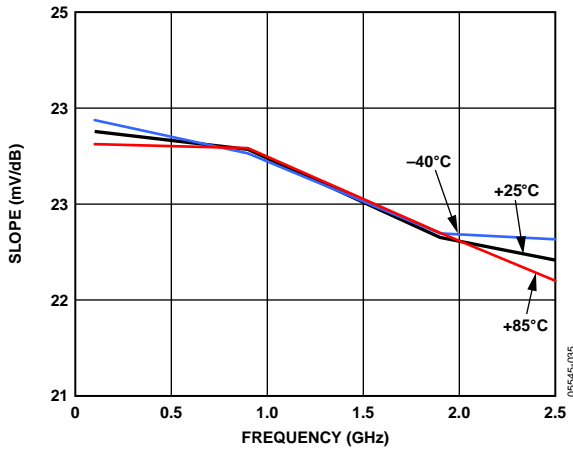

Figure 21. Slope vs. Frequency  
-40°C, +25°C, and +85°C

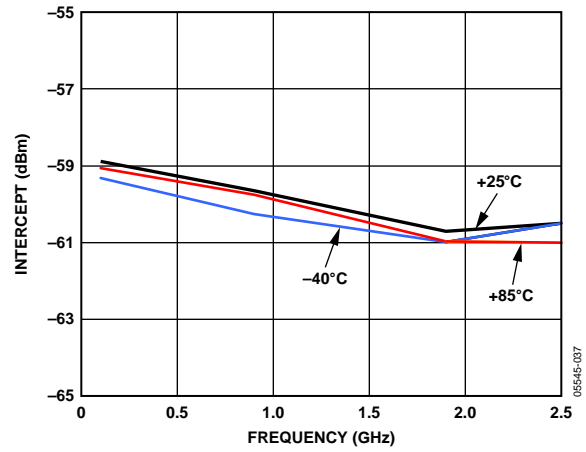

Figure 23. Intercept vs. Frequency  
-40°C, +25°C, and +85°C

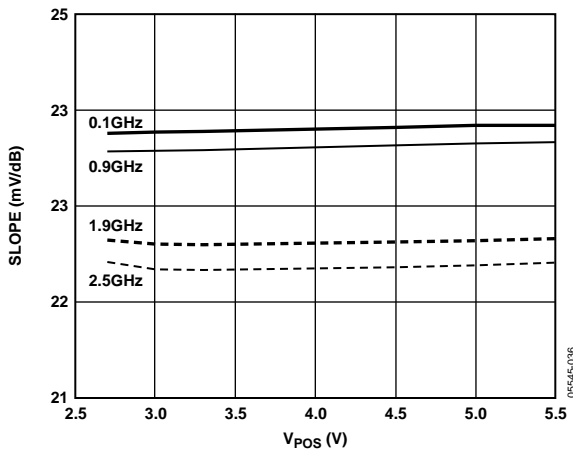

Figure 22. Slope vs. Supply Voltage

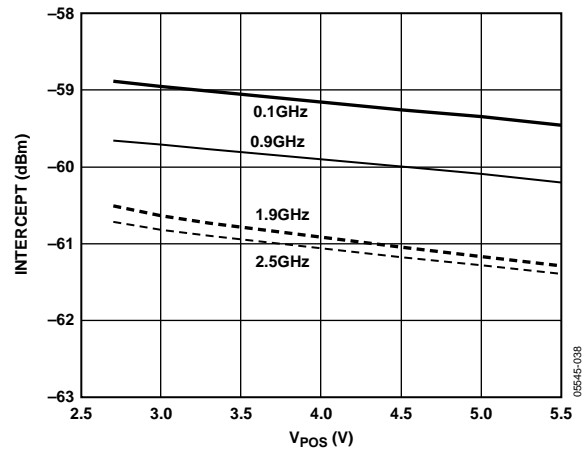

Figure 24. Intercept vs. Supply Voltage

Table 4. Typical Specifications at Selected Frequencies at 25°C (Mean and Sigma)

Frequency (GHz)	Slope (mV/dB)		Intercept (dBm)		±1 dB Dynamic Range			
	Mean	Sigma	Mean	Sigma	Low Point (dBm)		High Point (dBm)	
					Mean	Sigma	Mean	Sigma
0.1	23.8	0.1	-58.9	0.4	-44.5	0.8	+2.6	0.3
0.9	23.6	0.1	-59.7	0.4	-47.9	0.3	+2.8	0.1
1.9	22.7	0.1	-60.8	0.5	-48.0	0.6	-5.6	0.6
2.5	22.5	0.1	-60.6	0.5	-47.7	0.6	-6.2	0.5

## THEORY OF OPERATION

The AD8311 is a wideband logarithmic amplifier (log amp) similar in design to the AD8313, AD8314, and AD8315. Like the AD8315, it is strictly optimized for use in power control applications rather than as a measurement device. Figure 25 shows the main features in block schematic form. The output (Pin 2, VAPC) is intended to be applied directly to the automatic power-control (APC) pin of a power amplifier module.

### BASIC THEORY

Logarithmic amplifiers provide a type of compression in which a signal having a large range of amplitudes is converted to one of a smaller range. The use of the logarithmic function uniquely results in the output representing the decibel value of the input. The fundamental mathematical form is

$$V_{OUT} = V_{SLP} \log_{10} \frac{V_{IN}}{V_Z} \quad (1)$$

where:

$V_{IN}$  is the input voltage.

$V_Z$  is called the intercept (voltage) because when  $V_{IN} = V_Z$  the argument of the logarithm is unity and thus the result is zero.

$V_{SLP}$  is called the slope (voltage), which is the amount by which the output changes for a certain change in the ratio ( $V_{IN}/V_Z$ ).

When BASE-10 logarithms are used, denoted by the function  $\log_{10}$ ,  $V_{SLP}$  represents the volts/decade, and since a decade

corresponds to 20 dB,  $V_{SLP}/20$  represents the volts/dB. For the AD8311, a nominal (low frequency) slope of 24 mV/dB was chosen, and the intercept  $V_Z$  was placed at  $-59$  dBm for a sine wave input (251  $\mu$ V rms). However, both the slope and the intercept are dependent on frequency.

Keeping in mind that log amps do not respond to power but only to voltages and that the calibration of the intercept is waveform dependent and is only quoted for a sine wave signal, the equivalent power response can be written as

$$V_{OUT} = V_{DB} (P_{IN} - P_Z) \quad (2)$$

where the input power  $P_{IN}$  and the equivalent intercept  $P_Z$  are both expressed in dBm (thus, the quantity in parentheses is simply a number of decibels), and  $V_{DB}$  is the slope expressed in mV/dB. For a log amp having a slope  $V_{DB}$  of 24 mV/dB and an intercept at  $-59$  dBm, the output voltage for an input power of  $-30$  dBm is  $0.024 [-30 - (-57)] = 0.696$  V.

Further details about the structure and function of log amps can be found in data sheets for other log amps produced by Analog Devices. Refer to the data sheets for the AD640 and AD8307, both of which include a detailed discussion of the basic principles of operation and explain why the intercept depends on waveform, an important consideration when complex modulation is imposed on an RF carrier.

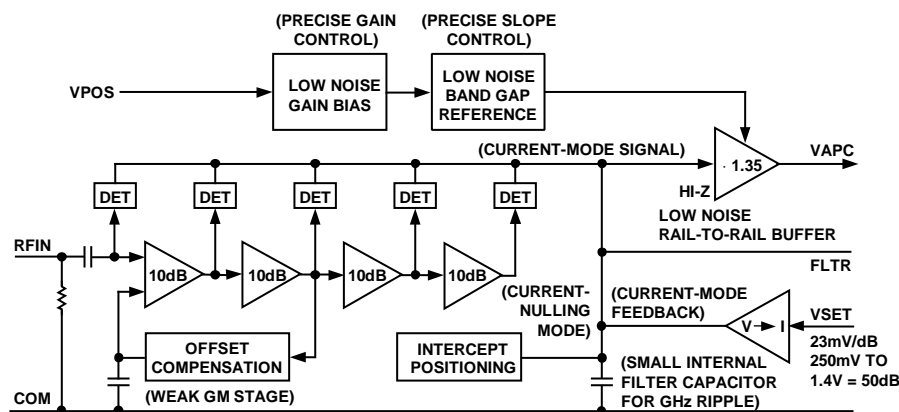

Figure 25. Block Schematic

# AD8311

The intercept need not correspond to a physically realizable part of the signal range for the log amp. Thus, the specified intercept is  $-58.9$  dBm at  $0.1$  GHz, whereas the smallest input for accurate measurement (a  $+1$  dB error) at this frequency is higher, about  $-44.5$  dBm. At  $2.5$  GHz, the  $+1$  dB error point shifts to  $-47.7$  dBm. This positioning of the intercept is deliberate and ensures that the  $V_{SET}$  voltage is within the capabilities of certain digital-to-analog converters (DACs), whose outputs cannot swing below  $200$  mV. Figure 26 shows the  $100$  MHz response of the AD8311; the vertical axis represents not the output (at the VAPC pin) but the value required at the power control pin (VSET) to null the control loop. This is explained in the Controller-Mode Log Amps section.

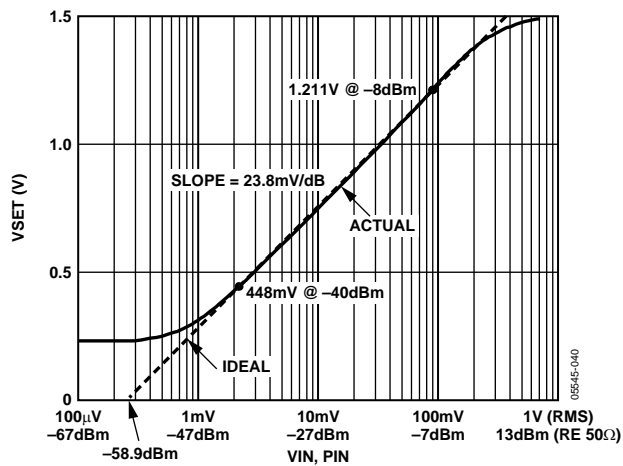

Figure 26. Basic Calibration of the AD8311 at 0.1 GHz

## CONTROLLER-MODE LOG AMPS

The AD8311 combines the two key functions required for the measurement and control of the power level over a moderately wide dynamic range. First, it provides the amplification needed to respond to small signals in a chain of four amplifier/limiter cells (see Figure 25), each having a small signal gain of  $10$  dB and a bandwidth of approximately  $3.5$  GHz. At the output of each of these amplifier stages is a full-wave rectifier, essentially a square law detector cell that converts the RF signal voltages to a fluctuating current having an average value that increases with signal level. A further passive detector stage is added before the first stage. These five detectors are separated by  $10$  dB, spanning some  $50$  dB of dynamic range. Their outputs are each in the form of a differential current, making summation a simple matter. It is readily shown that the summed output can closely approximate a logarithmic function. The log conformance error, which is the overall accuracy at the extremes of this total range viewed as the deviation from an ideal logarithmic response, can be judged by reference to Figure 6, which shows that errors across the central  $40$  dB are moderate.

In a device intended for measurement applications, this current would then be converted to an equivalent voltage, to provide the  $\log(V_{IN})$  function shown in Equation 1. However, the design of the AD8311 differs from standard practice in that its output needs to be a low noise control voltage for an RF power amplifier, not a direct measure of the input level. Further, it is highly desirable that this voltage be proportional to the time-integral of the error between the actual input  $V_{IN}$  and a dc voltage  $V_{SET}$  (applied to Pin 3, VSET).  $V_{SET}$  defines the setpoint, a target value for the power level typically generated by a DAC.

This is achieved by converting the difference between the sum of the detector outputs (still in current form) and an internally generated current proportional to  $V_{SET}$  to a single-sided current-mode signal. This, in turn, is converted to a voltage (at Pin 4, FLTR, the low-pass filter capacitor node) to provide a close approximation to an exact integration of the error between the power present in the termination at the input of the AD8311 and the setpoint voltage. Finally, the voltage developed across the ground-referenced filter capacitor  $C_{FLT}$  is buffered by a special low noise amplifier of low voltage gain ( $\times 1.35$ ) and presented at Pin 2 (VAPC) for use as the control voltage for the RF power amplifier. This buffer can provide rail-to-rail swings and can drive a substantial load current, including large capacitors. Note that the RF power amplifier is assumed to have a positive slope with RF power increasing monotonically with an increasing APC control voltage.

## CONTROL LOOP DYNAMICS

In order to understand how the AD8311 behaves in a complete control loop, an expression for the current in the integration capacitor as a function of the input  $P_{IN}$  and the setpoint voltage  $V_{SET}$  must be developed. Refer to Figure 27.

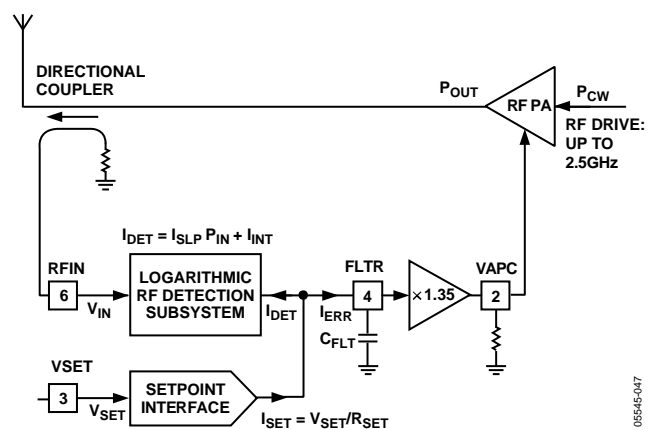

Figure 27. Behavioral Model of the AD8311

First, the summed detector currents are written as a function of the input power.

$$I_{DET} = I_{SLP} \times P_{IN} + I_{INT} \quad (3)$$

where:

$I_{DET}$  is the partially filtered demodulated signal, whose steady-state average value is extracted through the subsequent integration step.

$I_{SLP}$  is the slope, which has a value of 5.75  $\mu\text{A}/\text{dB}$ .

$P_{IN}$  is the input power in dBm (assuming 50  $\Omega$  input match).

$I_{INT}$  is the current intercept which, as previously noted, is dependent on the RF waveform (not the envelope). Assuming a sinusoidal input,  $I_{INT}$  is 350  $\mu\text{A}$ .

The current generated by the setpoint interface is simply

$$I_{SET} = V_{SET} / R_{SET} \quad (4)$$

where the  $R_{SET}$  resistor is 4.1 k $\Omega$ . The difference between this current and  $I_{DET}$  is applied to the loop filter capacitor  $C_{FLT}$ . At this point note that the inclusion of a filter resistor,  $R_{FLT}$ , can be helpful in improving the phase margin at low powers where the PA control gain (that is,  $\partial P_{OUT} / \partial V_{APC}$ ) is large, as is described later in this section. For now assume that  $R_{FLT}$  is zero. It follows that the voltage appearing on this capacitor,  $V_{FLT}$ , is the time-integral of the difference current.

$$V_{FLT}(s) = (I_{SET} - I_{DET}) / sC_{FLT} \quad (5)$$

$$= \frac{V_{SET} / R_{SET} - I_{SLP} \times P_{IN} - I_{INT}}{sC_{FLT}} \quad (6)$$

The control output  $V_{APC}$  is slightly greater than this, since the gain of the output buffer is  $\times 1.35$ , plus a slight offset voltage. The polarity is such that  $V_{APC}$  rises to its maximum value for any value of  $V_{SET}$  greater than the equivalent value of  $P_{IN}$ . That is, the AD8311 seeks to drive the RF power to its maximum value whenever it falls below the setpoint. The use of exact integration results in a dc error that is theoretically zero, and the logarithmic detection law would ideally result in a constant response time following a step change of either the setpoint or the power level if the power-amplifier control function were likewise linear-in-dB. This latter condition is rarely true, however, and it follows that in practice the loop response time depends on the power level. This effect can strongly influence the design of the control loop.

Equation 6 can be restated as

$$V_{APC}(s) = \frac{V_{SET} - V_{SLP} \times P_{IN} - V_{INT}}{sT} \quad (7)$$

where:

$V_{SLP}$  is  $I_{SLP} \times R_{SET}$ , which has a value of 24 mV/dB.

$V_{INT}$  is the voltage intercept given by  $I_{INT} \times R_{SET}$ , which has a value of 1.44 V.

$T$  is the effective time constant for the integration and is equal to  $R_{SET} \times C_{FLT} / 1.35$ . The factor of 1.35 arises because of the voltage gain of the buffer.

So the open-loop integration time constant can be written as

$$T_{OpenLoop} = R_{SET} \times C_{FLT} / 1.35 \quad (8)$$

To assess the closed-loop performance, refer to the block diagram in Figure 28 and calculate the loop transfer function. In general, the buffer time constant ( $\tau_{BUFFER}$ ) and the log amp time constant ( $\tau_{LOGAMP}$ ) can be neglected, except in the case of very high PA control function gains ( $>$  than 500 dB/V) and/or very wide PA control port bandwidths. Assuming that the frequency response of the output buffer and the log amp can be neglected, the overall transfer function can be expressed as

$$P_{OUT} = \frac{[I_{SET} + I_{SLP} \times 30 - I_{INT}] \times 1.35 \times (G_{PA} / (1 + s\tau_{PA})) \times (1 / sC_{FLT})}{1 + [I_{SLP} \times 1.35 \times (G_{PA} / (1 + s\tau_{PA}))] / sC_{FLT}} \quad (9)$$

Here,  $G_{PA}$  is the PA control function gain  $\partial P_{OUT} / \partial V_{APC}$  given in dB/V, and the factor of  $-30$  is due to the coupler.

The input power to the log amp,  $P_{IN}$ , is given in dBm and therefore is simply  $P_{OUT}$  of the PA minus the coupler value, typically  $-30$  dB, or  $P_{IN} = P_{OUT} - 30$ .

Equation 9 assumes that the next parasitic pole in the control loop comes from the PA. For a typical PA, a 1 MHz pole is not unusual, making this a good assumption. Therefore, except for in the case of a very wide bandwidth on the PA control port ( $>10$  MHz), the response time and stability of the control loop is mainly determined by the characteristics of the PA. This is true for both the gain and the phase response. It is essential to understand both the magnitude and frequency response of the power amplifier control port.

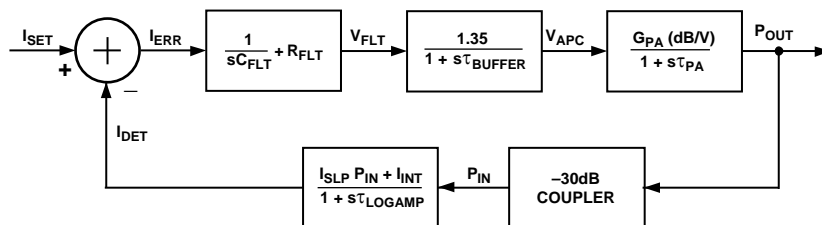

Figure 28. Control Loop Block Diagram

# AD8311

Continuing with the stability analysis, the gain of the control loop can be expressed as

$$\frac{\partial P_{OUT}}{\partial I_{SET}} = \frac{k}{1 + kA} \quad (10)$$

where:

$$k = \frac{1.35 \times G_{PA} \times (1/sC_{FLT})}{1 + s\tau_{PA}} \quad (\text{dB/A}) \quad (11)$$

$$A = I_{SLP} \quad (\text{A/dB}) \quad (12)$$

The effect of the zero resistor,  $R_{FLT}$ , can be easily included by replacing  $(1/sC_{FLT})$  with  $(R_{FLT} + 1/sC_{FLT})$ . The criteria for loop stability can be derived by setting the denominator of Equation 10 equal to 0, giving

$$0 = 1 + \frac{1.35 \times (1 + sR_{FLT}C_{FLT})}{(1 + s\tau_{PA}) \times sC_{FLT} / (G_{PA} \times I_{SLP})} \quad (13)$$

From Equation 13, the closed-loop integration time constant is given by

$$T_{ClosedLoop} = C_{FLT} / (G_{PA} \times I_{SLP} \times 1.35) \quad (14)$$

The gain and phase margins of the control loop can be deduced from the Bode plots of Equation 13.

## BASIC CONNECTIONS

Figure 29 shows the basic connections for operating the AD8311, and Figure 30 shows a block diagram of a typical application. The AD8311 is typically used in the RF power control loop of a mobile handset.

A supply voltage of 2.7 V to 5.5 V is required for the AD8311. The supply to the VPOS pin should be decoupled with a low inductance 0.1  $\mu\text{F}$  surface-mount ceramic capacitor, close to the device. The AD8311 has an internal input coupling capacitor, which negates the need for external ac-coupling. This capacitor, along with the low frequency input impedance of the device of approximately 2.14 k $\Omega$ , sets the minimum usable input frequency to around 0.016 GHz. A broadband 50  $\Omega$  input match is achieved in this example by connecting a 52.3  $\Omega$  resistor between RFIN and ground. A Smith chart plot of input impedance vs. frequency is shown in Figure 14. Other coupling methods are also possible (see the Input Coupling Options section).

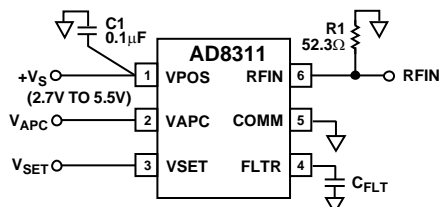

Figure 29. Basic Connections

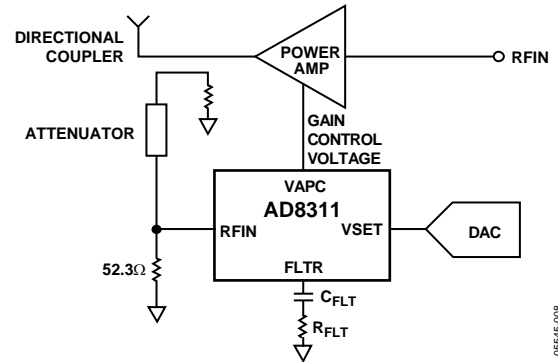

Figure 30. Typical Application

In a power control loop, the AD8311 provides both the detector and controller functions. A sample of the power amplifier's (PA) output power is coupled to the RF input of the AD8311, usually via a directional coupler. In dual mode applications, where there are two PAs and two directional couplers, the outputs of the directional couplers can be passively combined (both PAs will never be turned on simultaneously) before being applied to the AD8311.

A setpoint voltage is applied to VSET from the controlling source (generally this is a DAC). Any imbalance between the RF input level and the level corresponding to the setpoint voltage is corrected by the AD8311's  $V_{APC}$  output that drives the gain control terminal of the PA. This restores a balance between the actual power level sensed at the input of the AD8311 and the value determined by the setpoint. This assumes that the gain control sense of the variable gain element is positive, that is, an increasing voltage from VAPC tends to increase gain.

$V_{APC}$  can swing from 200 mV to within 100 mV of the supply rail and can source up to 6 mA. If the control input of the PA needs to source current, a suitable load resistor can be connected between VAPC and COMM. The output swing and current sourcing capability of VAPC is shown in Figure 11.

## RANGE ON VSET AND RFIN

The relationship between the RF input level and the setpoint voltage follows from the nominal transfer function of the device (see Figure 4, Figure 5, Figure 7, and Figure 8). At 0.9 GHz, for example, a voltage of 1 V on VSET indicates a demand for -18 dBm at RFIN. The corresponding power level at the output of the power amplifier is greater than this amount due to the attenuation through the directional coupler.

For setpoint voltages of less than approximately 150 mV,  $V_{APC}$  unconditionally remains at its minimum level of approximately 300 mV. This feature can be used to prevent any spurious emissions during power-up and power-down phases.

Above 250 mV,  $V_{SET}$  has a linear control range up to 1.4 V, corresponding to a dynamic range of 50 dB. This results in a slope of 23.8 mV/dB, or approximately 42.0 dB/V.



# AD8311

Some of the output power from the PA is coupled off using a dual-band directional coupler (Murata part number LDC15D190A0007A). This has a coupling factor of approximately +19 dB for the GSM band and +14 dB for DCS and an insertion loss of 0.38 dB and 0.45 dB, respectively. Because the PF08107B transmits a maximum power level of +35 dBm for GSM and +32 dBm for DCS, additional attenuation of 20 dB is required before the coupled signal is applied to the AD8311. This results in peak input levels to the AD8311 of -4 dBm (GSM) and -2 dBm (DCS). While the AD8311 gives a linear response for input levels up to +2 dBm, for highly temperature-stable performance at maximum PA output power the maximum input level should be limited to approximately -2 dBm (see Figure 5 and Figure 7). This does, however, reduce the sensitivity of the circuit at the low end.

The operational setpoint voltage, in the range 250 mV to 1.4 V, is applied to the VSET pin of the AD8311. This typically is supplied by a DAC. The AD8311's VAPC output drives the level control pin of the power amplifier directly. VAPC reaches a maximum value of approximately 2.5 V on a 2.7 V supply while delivering the 3 mA required by the level control input of the PA. This is more than sufficient to exercise the gain control range of the PA.

During initialization and completion of the transmit sequence, VAPC should be held at its minimum level of 300 mV by keeping VSET below 150 mV.

In this example, VSET is supplied by an 8-bit DAC that has an output range from 0 V to 2.55 V or 10 mV per bit. This sets the control resolution of VSET to 0.4 dB/bit (0.04 dB/mV times 10 mV). If finer resolution is required, the DAC's output voltage can be scaled using two resistors as shown. This converts the DAC's maximum voltage of 2.55 V down to 1.6 V and increases the control resolution to 0.25 dB/bit.

A filter capacitor (CFLT) must be used to stabilize the loop. The choice of CFLT depends to a large degree on the gain control dynamics of the power amplifier, something that is frequently poorly characterized, so some trial and error might be necessary.

In this example, a 150 pF capacitor is used and a 1.5 kΩ series resistor is included. This adds a zero to the control loop and increases the phase margin, which helps to make the step response of the circuit more stable when the PA output power is low and the slope of the PA's power control function is the steepest.

A smaller filter capacitor can be used by inserting a series resistor between VAPC and the control input of the PA. A series resistor works with the input impedance of the PA to create a resistor divider, which reduces the loop gain. The size of the resistor divider ratio depends on the available output swing of VAPC and the required control voltage on the PA.

This technique can also be used to limit the control voltage in situations where the PA cannot deliver the power level being demanded by VAPC. Overdrive of the control input of some PAs causes increased distortion. It should be noted, however, that if the control loop opens (that is, VAPC goes to its maximum value in an effort to balance the loop), the quiescent current of the AD8311 increases somewhat, particularly at supply voltages greater than 3 V.

Figure 32 shows the relationship between VSET and output power (P<sub>OUT</sub>) at 0.9 GHz. The overall gain control function is linear in dB for a dynamic range of over 40 dB. Note that for VSET voltages below 300 mV, the output power drops off steeply as VAPC drops toward its minimum level of 300 mV.

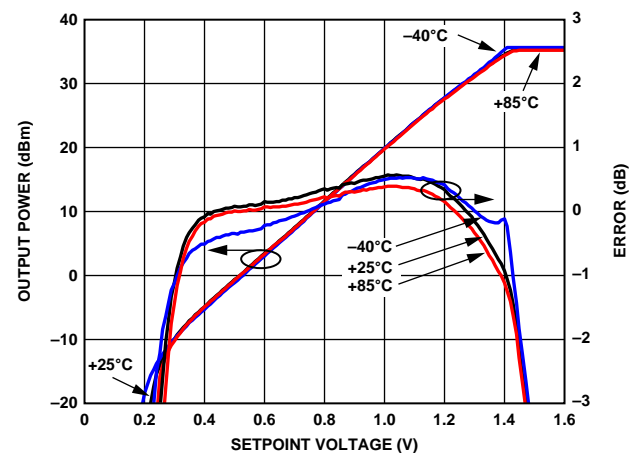

Figure 32. P<sub>OUT</sub> vs. V<sub>SET</sub> at 0.9 GHz for Dual Mode Handset Power Amplifier Application; -40°C, +25°C, and +85°C

## POWER-ON AND POWER-OFF

The AD8311 can be completely disabled by pulling the supply voltage to ground. The voltage on VSET should be kept below 150 mV during power-on and power-off to prevent any unwanted transients on VAPC.

## INPUT COUPLING OPTIONS

The internal 5 pF coupling capacitor of the AD8311 and the low frequency input impedance of 2.14 kΩ give a high-pass input corner frequency of approximately 16 MHz. This sets the minimum operating frequency. Figure 33, Figure 34, and Figure 35 shows three options for input coupling. A broadband resistive match can be implemented by connecting a shunt resistor to ground at RFIN (Figure 33). This 52.3 Ω resistor (other values can also be used to select different overall input impedances) combines with the input impedance of the AD8311 to give a broadband input impedance of 50 Ω. While the input resistance and capacitance (C<sub>IN</sub> and R<sub>IN</sub>) of the AD8311 vary from device to device by approximately ±20%, as well as in the same device over a range of frequencies (Figure 14), the dominance of the external shunt resistor means that the variation in the overall input impedance is close to the

tolerance of the external resistor. This method of matching is most useful in wideband applications or in multiband systems where there is more than one operating frequency.

A reactive match can also be implemented as shown in Figure 34. This is not recommended at low frequencies because device tolerances dramatically vary the quality of the match due to the large input resistance. For low frequencies, Figure 33 or Figure 35 is recommended.

In Figure 34, the matching components are drawn as generic reactances. Depending on the frequency, the input impedance, and the availability of standard value components either a capacitor or an inductor is used. As in the previous case, the input impedance at a particular frequency is plotted on a Smith Chart and matching components are chosen (shunt or series L, shunt or series C) to move the impedance to the center of the chart.

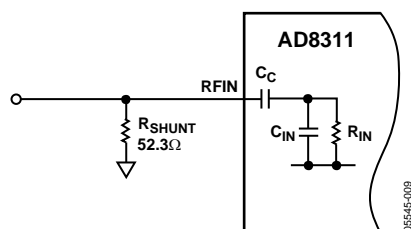

Figure 33. Broadband Resistive Input Coupling Option

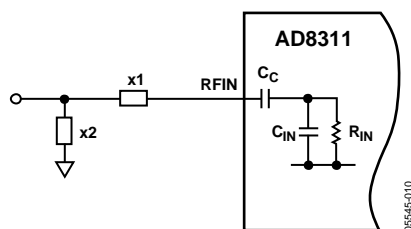

Figure 34. Narrow Band Reactive Input Coupling Option

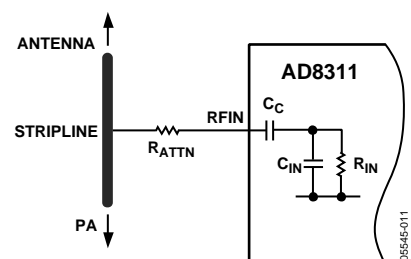

Figure 35. Series Attention Input Coupling Option

Figure 35 shows a third method for coupling the input signal into the AD8311. A series resistor connected to the RF source combines with the input impedance of the AD8311 to resistively divide the input signal being applied to the input. This has the advantage of very little power being tapped off in RF power transmission applications.

### TEMPERATURE DRIFT

Figure 36 shows the log slope and error over temperature for a 0.9 GHz input signal. Error due to drift over temperature consistently remains within  $\pm 1$  dB and only begins to exceed this limit when the ambient temperature goes above  $+65^\circ\text{C}$  and below  $-20^\circ\text{C}$ . For all frequencies using a reduced temperature range, higher measurement accuracy is achievable.

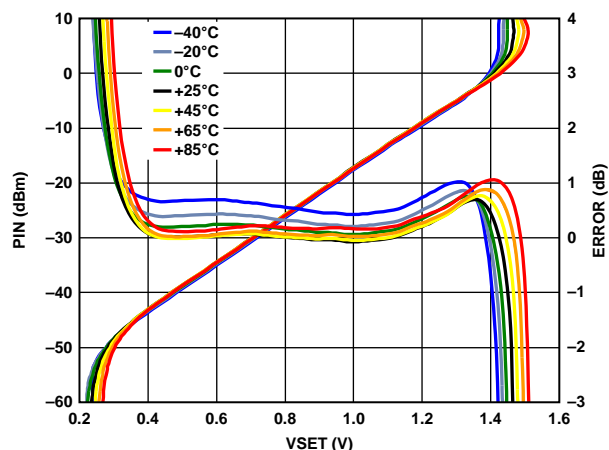

Figure 36. Typical Drift at 900 GHz for Various Temperatures

### DEVICE CALIBRATION AND ERROR CALCULATION

The measured transfer function of the AD8311 at 0.9 GHz is shown in Figure 37. The figure shows plots of both input power and calculated error vs. setpoint voltage.

The vertical axis represents the input power required at the RFIN pin to null the control loop when a VSET voltage is applied. As the setpoint voltage varies from about 0.2 V to 1.5 V, the corresponding input power varies from  $-60$  dBm to  $+10$  dBm.

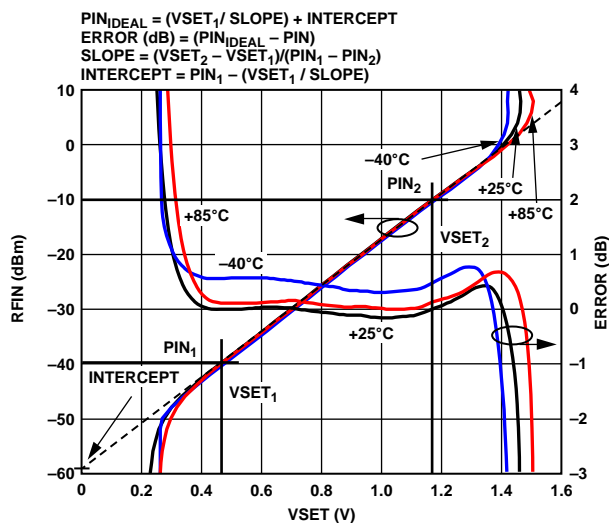

Figure 37. Transfer Function of AD8311 at 0.9 GHz

Because slope and intercept vary from device to device, board-level calibration must be performed to achieve high accuracy.



# AD8311

In a control loop, calibration is performed by applying two levels to the AD8311's setpoint voltage and measuring the corresponding power. The calibration points are generally chosen to be within the linear-in-dB operating range of the device (see Figure 37). Calculation of slope and intercept is done using the equations

$$SLOPE = (V_{SET2} - V_{SET1}) / (P_{IN2} - P_{IN1}) \quad (15)$$

$$INTERCEPT = P_{IN1} - (V_{SET1} / SLOPE) \quad (16)$$

Once slope and intercept have been calculated, an equation can be written which allows calculation of an (unknown) power based on the setpoint voltage.

$$P_{IN} = (V_{SET} / SLOPE) + INTERCEPT \quad (17)$$

Using Equation 17 as a reference for the ideal input power, the log conformance error of the measured data can be calculated:

$$ERROR(dB) = (P_{IN,IDEAL} - P_{IN,MEASURED}) \quad (18)$$

Figure 37 includes a plot of the error at 25°C, the temperature at which the AD8311 is calibrated. Note that the error is not zero. This is because the AD8311 does not perfectly follow the ideal  $V_{SET}$  vs.  $P_{IN}$  equation, even within its operating region. The error at the calibration points (0.45 V and 1.15 V in this case) is, however, equal to zero by definition.

Figure 37 also includes error plots for the output voltage at -40°C and +85°C. These error plots are calculated using the slope and intercept at +25°C. This is consistent with calibration in a mass-production environment where calibration at temperature is not practical.

## SELECTING CALIBRATION POINTS TO IMPROVE ACCURACY OVER A REDUCED RANGE

In some applications very high accuracy is required at just one power level or over a reduced input range. For example, in a wireless transmitter, the accuracy of the high power amplifier (HPA) is most critical at or close to full power.

Figure 38 shows the same measured data as Figure 37. Notice that accuracy is very high from -15 dBm to 0 dBm. Below -15 dBm the error increases to about -2 dB. This is because the calibration points have been changed to approximately 0.975 V and 1.3 V.

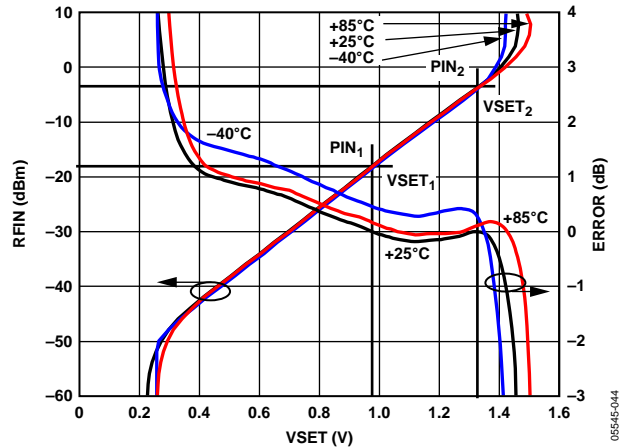

Figure 38. Output Voltage and Error vs.  $P_{IN}$  with 2-Point Calibration at Approximately 0.975 V and 1.3 V

Calibration points should be chosen to suit the application at hand. In general, though, the calibration points should never be chosen in the nonlinear portion of the log amp's transfer function (above 1.4 V or below 0.35 V in this case).

Figure 39 shows how calibration points can be adjusted to increase dynamic range, but at the expense of linearity. In this case the calibration points for slope and intercept are set at 0.37 V and 1.37 V. These points are at the end of the device's linear range. Once again at 25°C we see an error of 0 dB at the calibration points. Note also that the range over which the AD8311 maintains an error of less than  $\pm 0.5$  dB is extended to more than 45 dB at 25°C and more than 40 dB over temperature. The disadvantage of this approach is that linearity suffers, especially in the middle of the range.

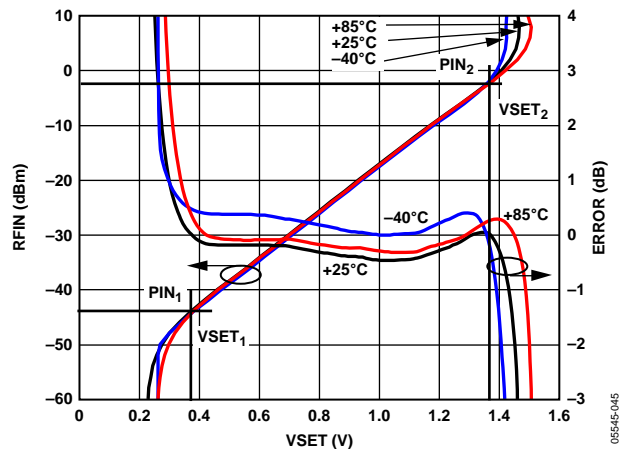

Figure 39. Dynamic Range Extension by Choosing Calibration Points that are Close to the End of the AD8311's Linear Range

Another way of presenting the error function of a log amp detector is shown in Figure 40. In this case, the dB error at hot and cold temperatures is calculated with respect to the transfer function at ambient. This is a key difference in comparison to the previous plots. Up to now, all errors have been calculated with respect to the ideal transfer function at ambient.

When we use this alternative technique, the error at ambient becomes by definition equal to 0 (see Figure 40).

This would be valid if the device transfer function perfectly followed the ideal  $P_{IN} = V_{SET} / \text{SLOPE} + \text{INTERCEPT}$  equation. However since a log amp in practice never perfectly follows this equation (especially outside of its linear operating range), this plot tends to artificially improve linearity and extend the dynamic range. This plot is a useful tool for estimating temperature drift at a particular power level with respect to the (nonideal) response at ambient. However, achieving this level of accuracy in an end application requires calibration at multiple points in the device's operating range.

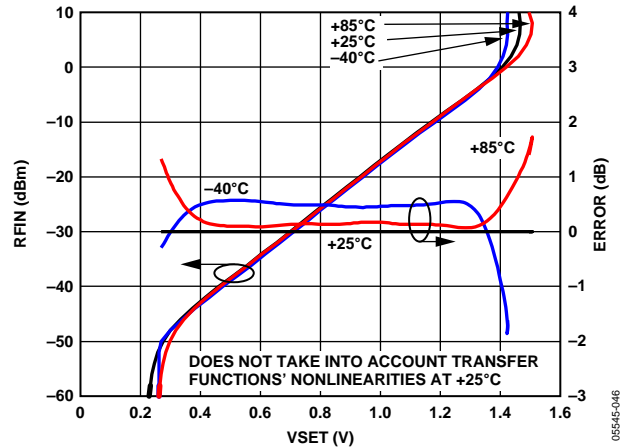

Figure 40. Error vs. Temperature with respect to Output Voltage at 25 °C

## DEVICE HANDLING

The wafer-level chip scale package consists of solder bumps connected to the active side of the die. The part is lead-free with 95.5% tin, 4.0% silver, and 0.5% copper solder bump composition. The WLCSP package can be mounted on printed circuit boards using standard surface-mount assembly techniques; however, caution should be taken to avoid damaging the die. See the AN-617 application note for additional information. WLCSP devices are bumped die, and exposed die can be sensitive to light condition, which can influence specified limits.

## EVALUATION BOARD

Figure 41 shows the schematic of the AD8311 WLCSP evaluation board. The layout and silkscreen of the component and circuit sides are shown in Figure 42 to Figure 45. The board is powered by a single supply in the range 2.7 V to 5.5 V. The power supply is decoupled by a 0.1  $\mu\text{F}$  capacitor. A 100 pF capacitor provides additional supply decoupling, but is not necessary for basic operation.

Table 5 details the various configuration options of the evaluation board.

For operation in controller mode, both jumpers J1 and J2 should be removed. The setpoint voltage is applied to VSET, RFIN is connected to the RF source (PA output or directional coupler), and VAPC is connected to the gain control pin of the PA. When used in controller mode, a capacitor must be installed in C4 for loop stability (R2 must also be installed, 0  $\Omega$

by default). For GSM/DCS handset power amplifiers, this capacitor should typically range from 150 pF to 300 pF.

A quasi-measurement mode (where the AD8311 delivers an output voltage that is proportional to the log of the input signal) can be implemented, to establish the relationship between VSET and RFIN, by installing the two jumpers J1 and J2. This mimics an AGC loop. To establish the transfer function of the log amp, the RF input should be swept while the voltage on VSET is measured, that is, the SMA connector labeled VSET now acts as an output. This is the simplest method to validate operation of the evaluation board. When operated in this mode, a large capacitor (0.01  $\mu\text{F}$  or greater) must be installed in C4 (filter capacitor) to ensure loop stability. The op amp must be powered with a nominal voltage of 2.7 V to 5.5 V with the VS supply. Alternately, J3 can be installed to power the op amp with the AD8311's VPOS power supply.

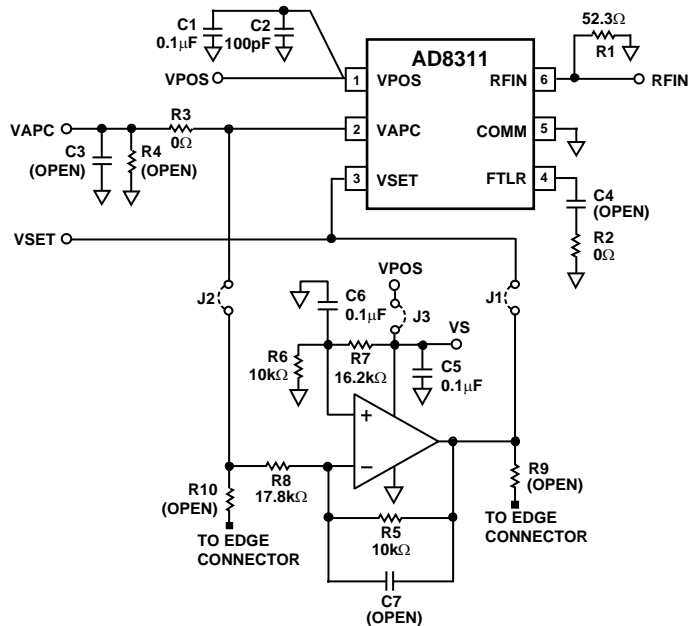

Figure 41. Evaluation Board Schematic

09545-012

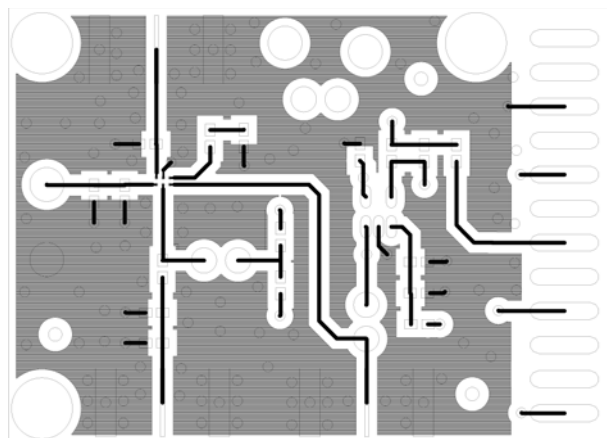

Figure 42. Layout of Component Side (WLCSP)

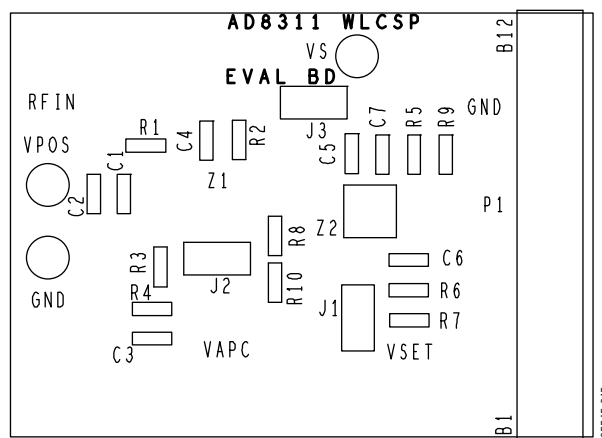

Figure 44. Silkscreen of Component Side (WLCSP)

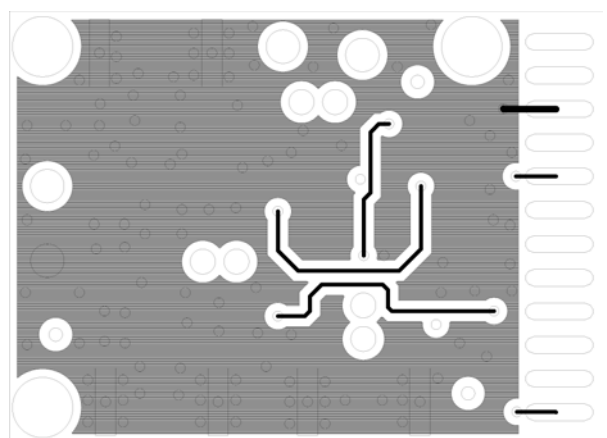

Figure 43. Layout of Circuit Side (WLCSP)

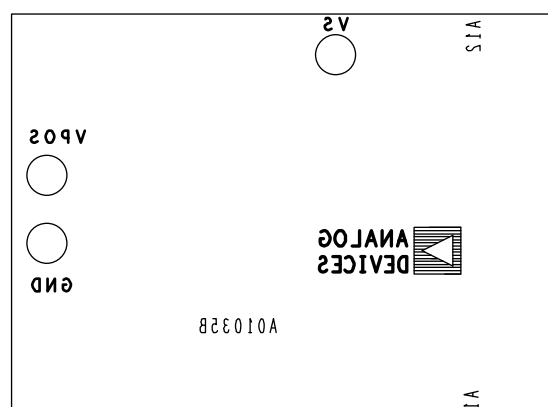

Figure 45. Silkscreen of Circuit Side (WLCSP)

Table 5. Evaluation Board Configuration Options

Component	Function	Default Condition
VPOS, GND	Supply and Ground Vector Pins.	Not Applicable
R1	Input Interface. The 52.3 $\Omega$ resistor in Position R1 combines with the AD8311's internal input impedance to give a broadband input impedance of around 50 $\Omega$ . Note that the AD8311's RF input is internally ac-coupled.	R1 = 52.3 $\Omega$ (Size 0402)
R3, R4, C3	Output Interface. R4 and C3 can be used to check the response of $V_{APC}$ to capacitive and resistive loading. R3/R4 can be used to reduce the slope of $V_{APC}$ .	R3 = 0 $\Omega$ (Size 0402) R4 = C3 = open (Size 0402)
C1, C2	Power Supply Decoupling. The nominal supply decoupling consists of a 0.1 $\mu\text{F}$ capacitor at C1. C2 can be used for additional supply decoupling.	C1 = 0.1 $\mu\text{F}$ (Size 0402) C2 = 100 pF (Size 0402)
C4, R2	Filter Capacitor. The response time of $V_{APC}$ can be modified by placing a capacitor between FLTR (Pin 4) and ground. The control loop phase margin can be increased by adding a series resistor.	C4 = open (Size 0402) R2 = 0 $\Omega$ (Size 0402)
J1, J2, J3	Measurement Mode. A quasi-measurement mode can be implemented by installing J1 and J2 (connecting an inverted $V_{APC}$ to $V_{SET}$ ) to yield the nominal relationship between RFIN and VSET. In this mode, a large capacitor (0.01 $\mu\text{F}$ or greater) must be installed in C4. J3 can be installed to power the op-amp with the VPOS power supply. Alternately, the op-amp can be powered with the VS supply pin.	J1, J2 = installed J3 = installed
R9, R10	Alternate Interface. R5 and R6 allow for VOUT and VSET to be accessible from the edge connector, which is only used for characterization.	R9 = R10 = open (Size 0402)

OUTLINE DIMENSIONS

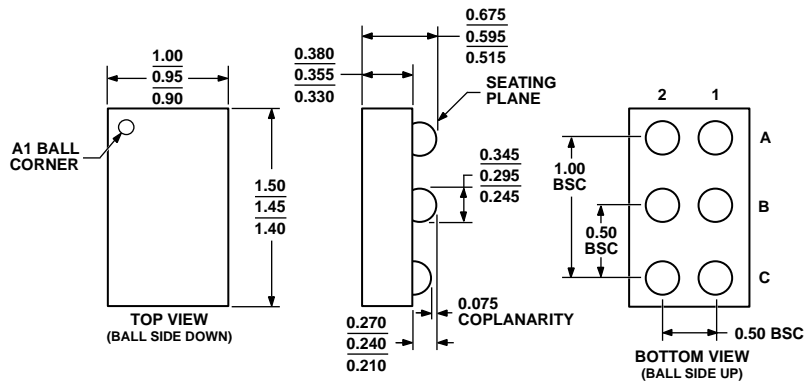

Figure 46. 6-Ball Wafer Level Chip Scale Package [WLCSP]  
(CB-6-2)  
Dimensions shown in millimeters

081607-B

ORDERING GUIDE

Model <sup>1</sup>	Temperature Range	Package Description	Package Option	Branding	Ordering Quantity
AD8311ACBZ-P7	-40°C to +85°C	6-Ball Wafer Level Chip Scale Package [WLCSP], 7" Pocket Tape and Reel	CB-6-2	Q04	3000
AD8311ACBZ-P2	-40°C to +85°C	6-Ball Wafer Level Chip Scale Package [WLCSP], 7" Pocket Tape and Reel	CB-6-2	Q04	250
AD8311-EVAL		Evaluation Board			

<sup>1</sup> Z = RoHS Compliant Part.

**NOTES**

**AD8311**

**NOTES**

# Mouser Electronics

Authorized Distributor

Click to View Pricing, Inventory, Delivery & Lifecycle Information:

[Analog Devices Inc.:](#)

[AD8311ACBZ-P7](#)